



“АЕЦ Козлодуй” ЕАД, гр.Козлодуй

ОДОБРЯВАМ
ИЗПЪЛНИТЕЛЕН ДИРЕКТОР
ИВАН АНДРЕЕВ



Иван Андреев

ДОКУМЕНТАЦИЯ

За участие в публично състезание

за възлагане на обществена поръчка с предмет:

**“ Реконструкция на панели, доставка и монтаж на
оборудване на симулатор с макет на
БЩУ “АЕЦ Козлодуй” блок 6”**

СЪДЪРЖАНИЕ

На документация за участие в публично състезание за възлагане на обществена поръчка с предмет: **“Реконструкция на панели, доставка и монтаж на оборудване на симулатор с макет на БЩУ "АЕЦ Козлодуй" блок 6”**

Част	Наименование	Брой Страници
1	Техническо задание № 2016.ПУТЦ.ПМС.ТЗ.20, съдържащо техническа спецификация за строителство и количествено-стойностна сметка	119
2	Образци на документи	7
2.1	Образец на оферта	2
2.2	Образец на спецификация на оборудване, консумативи и резервни части	1
2.2	Образец на декларация по чл. 39, ал. 3, т. 1, б.в, г, д” от ППЗОП	1
2.3	Образец на декларация за гаранционен срок на извършените строителни и монтажни работи, гаранционен срок на оборудването и гаранционни условия	2
2.4	Образец на декларация основни показатели за ценообразуване	1
2.5	Образец на банкова гаранция за обезпечение изпълнението на договор	1
3	Указания за подготовка на офертата	6
4	Проект на договор	18
4.1	Специфични условия на договора	6
4.2	Общи условия на договора	12

“АЕЦ КОЗЛОДУЙ” ЕАД

Блок: ОСО

Система: ПМС 1000

Подразделение: управление П и УТЦ

УТВЪРЖДАВАМ,

ЗАМ. ИЗПЪЛНИТЕЛЕН ДИРЕКТОР:

01. 02. 2016 г. ИВАН АНДРЕЕВ



СЪГЛАСУВАЛИ:

ДИРЕКТОР Б и К:..... 02.02.2016

/ПЛАМЕН ВАСИЛЕВ/

ДИРЕКТОР “ПРОИЗВОДСТВО”:..... 02.02.16

/ЯНЧО ЯНКОВ/

ТЕХНИЧЕСКО ЗАДАНИЕ

№ 2016.ПМЦ.ПМС.ПЗ.20

за доставка и монтаж

Тема: Реконструкция на панели, доставка и монтаж на оборудване на симулатор с макет на БЦУ АЕЦ ”Козлодуй” блок 6

Настоящото техническо задание съдържа пълно описание на предмета на поръчката и техническа спецификация съгласно Закона за обществените поръчки.

1 Кратко описание на ТЗ

Техническото задание се изготвя във връзка с необходимостта от поддържане и висока разполагаемост на ПМС 1000 и съответствие между контролната му зала и контролната зала на референтния блок. Тази необходимост произтича от изискванията на АЯР за специализирано обучение.

Съгласно изискванията на АЯР – чл. 24 на НАРЕДБА за условията и реда за придобиване на професионална квалификация и за реда за издаване на лицензии за специализирано обучение и на удостоверения за правоспособност за използване на ядрената енергия ПМС 1000 трябва да бъде в съответствие с референтния си блок, за да може да се поддържа лицензът на дружеството за специализирано обучение, в частност на симулаторно обучение на оператори за БЦУ-5, 6. Обемът на дейностите по актуализацията на симулатора към референтния блок 6 на “АЕЦ Козлодуй” ЕАД се определя от изпълнените изменения на блока след ПГР. При изпълнението на актуализацията е необходимо да се гарантира, че крайният вид на БЦУ на ПМС 1000 и на БЦУ-6 ще са идентични.

След ПГР 2015 на блок 6 са реализирани технически решения № 4871(Иидентификатор в ИС ОЕД ЕП-2.ТР.1552), № 4774(Иидентификатор в ИС ОЕД ЕП-2.ТР.1424):

- Замяна на сигнализацията на панели 6НУ14А, 6НУ25 до 36 и НК13 (участъци 12 до 24) със светодиодни табла;
- Климатизация на помещения 6А311;6А322;6А333;6АК041/1; 6АК041/2; 6АК041/3;6АК316,6АК621;6АК622;6АК623;6ДК1903 с електронно оборудване на панели ПТК и АХК;

За осъществяване на техническото задание се предвиждат следните дейности:

- реконструкция на панелите на макета на БЩУ блок 6 на ПМС 1000
- демонтаж, монтаж и окабеляване на оборудване по панелите
- Доставка на оборудване и резервни части

2 Изисквания към доставката и производството на оборудването и материалите

2.1 Описание на изработваното и доставяното оборудване и материали, необходими за окомплектоване на панелите

Но	Техническа характеристика	Мярка	Количество
1.	Планшет за монтаж на фасадки - 2 реда x 9 фасадки	бр.	9
2.	Планшет за монтаж на фасадки – 1 ред x 9 фасадки	бр.	3
3.	Планшет за монтаж на фасадки – 4 реда x 7 фасадки	бр.	2
4.	Планшет за монтаж на фасадки – 3 реда x 7 фасадки	бр.	1
5.	Планшет за монтаж на фасадки – 4 реда x 9 фасадки	бр.	1
6.	Планшет за монтаж на фасадки – 5 реда x 9 фасадки	бр.	1
7.	Планшет за монтаж на фасадки – 4 реда x 5 фасадки	бр.	2
8.	Планшет за монтаж на фасадки – 2 реда x 5 фасадки	бр.	1
9.	Планшет за монтаж на фасадки – 4 реда x 13 фасадки	бр.	1
10.	Планшет за монтаж на фасадки – 2 реда x 13 фасадки	бр.	1
11.	Планшет за монтаж на фасадки – 30 фасадки(нестандартен размер)	бр.	2
12.	Фасадка с 4 броя светодиоди – цвят бял	бр.	298
13.	Фасадка с 4 броя светодиоди – цвят оранжев	бр.	187
14.	Фасадка с 4 броя светодиоди – цвят червен	бр.	102
15.	Шест канална светлинна касета LSB-6 със захранване 24VDC	бр.	2

Чертежи с размерите на планшетите монтирани на блочния щит на 6 ЕБ на АЕЦ „Козлодуй” са дадени в Приложение 3. Изпълнителят трябва да направи оглед на панелите, ако е необходимо. Планшета да бъде с цвета на панела на които се монтира съответния планшет.

Фасадките трябва да са изработени с 4 броя светодиода, с работно напрежение 24 VDC, с еднакъв цвят и интензитет на светлината и с функционални характеристики идентични на монтираните на 6 ЕБ на АЕЦ „Козлодуй”. Външният изглед на фасадките трябва да е същият като на фасадките монтирани на 6 ЕБ на АЕЦ „Козлодуй”. Чертежи с разпределението на фасадките по панели са дадени в Приложение 2. Описание на формата и изискванията за етикета на фасадките се съдържа в Приложение №6.

Точното описание на доставката и количествата е представено в приложената техническа спецификация за доставка Приложение №8.

2.2 Консумативи и резервни части

No	Техническа характеристика	Мярка	Количество
1.	Фасадка с 4 броя светодиоди – цвят бял	бр.	22
2.	Фасадка с 4 броя светодиоди – цвят оранжев	бр.	13
3.	Фасадка с 4 броя светодиоди – цвят червен	м	18
4.	Проводник многожилен H05V-K 0,35mm ² - цвят бял	м	4000
5.	Проводник многожилен H05V-K 0,35mm ² - цвят червен	м	500
6.	Колиета 100 x 2.5 mm - цвят natural	бр.	3000
7.	Колиета 150 x 2.5 mm – цвят natural	бр.	3000
8.	Монтажна пета Mounting Pad 28 x 28 mm	бр.	1000
9.	Иглени накрайници за кабелни жила (0.5 mm ²)	бр.	2000

3 Изисквания към строително-монтажните работи

3.1 Инвеститор

Инвеститорски функции по отношение на приемане, контрол и координация на работата ще упражнява Управление “Инвестиции”. Технически контрол от страна на “АЕЦ Козлодуй” ЕАД ще се упражнява от сектор ИО на управление П и УТЦ.

3.2 План за изпълнение на СМР

3.2.1 Реконструкция на панели НУ14А, НУ25, НУ26, НУ27, НУ28, НУ29, НУ30, НУ31, НУ32, НУ33, НУ34, НУ35, НУ36

- Демонтаж на кабелни връзки по списък даден в Приложение 4. Демонтираните кабели да се изтеглят от кабелното трасе;
- Демонтаж на светлинни табла ТСБ;
- Демонтаж на блокове с оптрони;
- Реконструкция на панелите за монтаж на планшети (Приложение 3);
- Монтаж на планшети;
- Монтаж на светодиодни табла за сигнализация. Да се извърши проверка на съответствието на цветовете и надписите на фасадките съгласно Приложение 2;
- Монтаж на кабелни връзки по списък даден в Приложение 5. Да се използват съществуващите кабелни трасета;

3.2.2 Реконструкция на панел НЗ20

- Реконструкция на панела за монтаж на на 2 броя шест канална светлинна касета LSB-6;
- Монтаж на 2 броя шест канална светлинна касета LSB-6;
- Монтаж на кабелни връзки по списък даден в Приложение 5. Да се използват съществуващите кабелни трасета;

Точното описание на обема, вида на работите и разбивка по количества е представено в приложената количествена сметка Приложение №7.

Чертежи с разпределението на фасадките по панели са дадени в Приложение 2.

Дейностите по реконструкция на панелите, монтаж/демонтаж на оборудването и окабеляване ще започнат след осигуряване фронт за работа от Възложителя и изпълнени доставки от Изпълнителя.

Крайният срок за изпълнение на реконструкцията е един месец след осигуряване на фронт за работа.

3.3 Условия и дейности, които трябва да се изпълнят от АЕЦ Козлодуй ЕАД
Осигуряване ел. захранване на електрическите инструменти и апарати на Изпълнителя.

4 Нормативно-технически документи приложими към СМР и въвеждане в експлоатация

Правилник за безопасност и здраве при работа в електрическите уредби на електрически и топлофикационни централи и по електрически мрежи – 2004 г.

Правилник за безопасност при работа в не електрическите уредби на електрически и топлофикационни централи и по електрически мрежи – 2004 г.

НАРЕДБА № 3 от 18.09.2007 г. за технически правила и нормативи за контрол и приемане на електромонтажните работи

Наредба № 2 от 22.03.2004г. за минимални изисквания за здравословни и безопасни условия на труд при извършване на СМР;

Наредба № Из-1971 от 2009 г. за строително-техническите правила и норми за осигуряване на безопасност при пожар;

ДБК.КД.ИН.028, “ИК. Работа на външни организации при сключен договор”.

УТЦ.РД.ИБ.001, “Инструкция за осигуряване на пожарна безопасност в сградата на управление П и УТЦ”.

5 Документи, които се изискват при доставка, монтаж и въвеждане в експлоатация

- Паспорт на оборудването;
- Инструкции за монтаж, експлоатация, техническо обслужване и ремонт;
- Чертежи и технически условия;
- Сертификат/ Декларация за съответствие;
- Декларация за произход на доставените материали;

Документите да се представят на хартиен носител в 1 екземпляр на оригиналния език, 3 екземпляра на български език (с изключение на сертификати, протоколи и декларации) и на CD – 1 екземпляр.

6 Входящ контрол

Доставеното оборудване и материали да преминат общ входящ контрол по установения ред в “Инструкция по качеството за провеждане на входящ контрол на доставените материали, суровини и комплектуващи изделия в АЕЦ“Козлодуй” ЕАД, №ДОД.КД.ИК.112.

7 Изходни документи, резултат от договора

7.1. На етап доставка – документите описани в т.5

7.2. На етап СМР:

- Акт за извършена работа;
- Акт за демонтаж;
- Акт за монтаж;
- Приемо-предавателни протоколи;
- Протоколи от ПНР и въвеждане в експлоатация;

Отчетните документи, изготвени от Изпълнителя, преминават проверка и съгласуване от Възложителя.

8 Критерии за приемане на работата

Всички доставки от т.2 се считат за изпълнени след проведен общ входящ и оформен Протокол за входящ контрол без забележки.

Всички дейности по монтаж/демонтаж описани в т.3 и Приложение 7, се считат за изпълнени след:

- Проверка на функционалността от представител на управление П и УТЦ, сектор ИО. Установяване на съответствието на реконструираните панели по т.2 с тези на БЩУ 6 да се установи чрез проверка от инструктор-оператор.

- Спазени срокове на изпълнение.

- Предадена и съгласувана отчетна документация

9 Осигуряване на качеството

9.1 Общи изисквания

Изпълнителят да притежава сертифицирана система за управление на качеството по ISO 9001:2008.

Изпълнителят да изготви Програма за осигуряване на качеството до един месец след подписване на договора. Програмата служи за определяне на подробен график, отговорностите по всяка от задачите по договора и ред за изпълнението им. Програмата подлежи на съгласуване от АЕЦ. Програмата трябва да бъде изготвен на основание на:

- Техническото задание и договора;
- Системата по качество на изпълнителя;
- Примерно съдържание, предоставено от възложителя.

9.2 Специфични изисквания по отношение на осигуряване на качеството

• Обозначаването на оборудването в проекта трябва да се извършва по правилата за присвояване на технологични обозначения;

• Обозначаването на документите, изготвени от изпълнителя в изпълнение на ТЗ, трябва да съдържат индекса на ТЗ или номера на договора. Всеки отделен документ трябва да

има един уникален индекс, поставен от разработчика/проектанта, и номер на редакция. Корекциите, приети в проектната документация, се въвеждат чрез издаване на нова редакция;

- На всички нови и съществуващи кабели да бъдат поставени кабелни маркировки. Маркировката на кабелите да се съгласува с възложителя;

- Изпълнителят трябва да коригира вследствие на реконструкцията, надписите на съответните панели и те трябва да отговарят на надписите на съответния панел на референтния блок.

9.3. Квалификация на Изпълнителя

- Изпълнителят да притежава опит в изпълнението на дейности, свързани с реконструкцията на панели и монтиране на оборудване в електроцентрали.

- Изпълнителите и ръководителите на монтажните дейности да притежават необходимата за съответната дейност квалификационна група по Правилник за безопасност и здраве при работа в електрически уредби на електрически и топлофикационни централи и по електрически мрежи (ПБЗР-ЕУ) и Правилник за безопасност при работа в неелектрически уредби на електрически и топлофикационни централи и по топлопреносни мрежи и хидротехнически съоръжения (ПБР-НУ).

- Дейностите по необходимите ПНР на оборудването да се извършват от орган за контрол от вида С (А), акредитиран по БДС EN ISO/IEC 17020, за дейности покриващи предмета на поръчката.

10 Гаранционни условия

Изпълнителят осигурява гаранционно обслужване на монтираните съоръжения в продължение на 2 години след датата на приемане на монтажа.

При открити дефекти, след писмено уведомяване на доставчика, те трябва да се отстранят в срок от 30 дни, като транспортните разходи са за сметка на доставчика.

Гаранционния срок на изпълнените СМР, след въвеждане в експлоатация не трябва да бъде по-малък от изискванията на Наредба 2 за въвеждане в експлоатация на строежите в Република България и минимални гаранционни срокове за изпълнени строителни и монтажни работи, съоръжения и строителни обекти, 2003г.

11 Контрол от страна на „АЕЦ Козлодуй” ЕАД

“АЕЦ Козлодуй” ЕАД има право да извършва инспекции и проверки на дейностите, извършвани на площадката. С подписването на договора Изпълнителят гарантира съгласието си с това условие и гарантира осигуряване на достъп до персонал, помещения, съоръжения, инструменти и документи, използвани от външните организации и техни подизпълнители.

12 Прилагане на изискванията към подизпълнители на основния изпълнител

Основният изпълнител по договора носи отговорност за изпълнението на изискванията на техническо задание от подизпълнителите, в зависимост от изпълняваните дейности, както и за качеството на тяхната работа, при наличие на такива.

13 ПРИЛОЖЕНИЯ:

Приложение №1 - Схема на симулаторния комплекс на ПМС-1000

Приложение №2 - Разположение на фасадките по панели

Приложение №3 – Чертежи на планшети

Приложение №4 – Списък на кабелни връзки за премахване

Приложение №5 – Списък на кабелни връзки за добавяне

Приложение №6 – Формат на етикет на фасадките

Приложение №7 – Количествена сметка на дейностите

Приложение №8 – Техническа спецификация на доставката

Ръководител у-е П и УТЦ:.....



/Емилиян Едрев/

Програма за финансиране

Наименование на програмата за финансиране (ИП, ПП, РП и др.)	№ на мярка от програма / код на мероприятие МИС ВааН
ИП 164	234 44610910

NOTES:

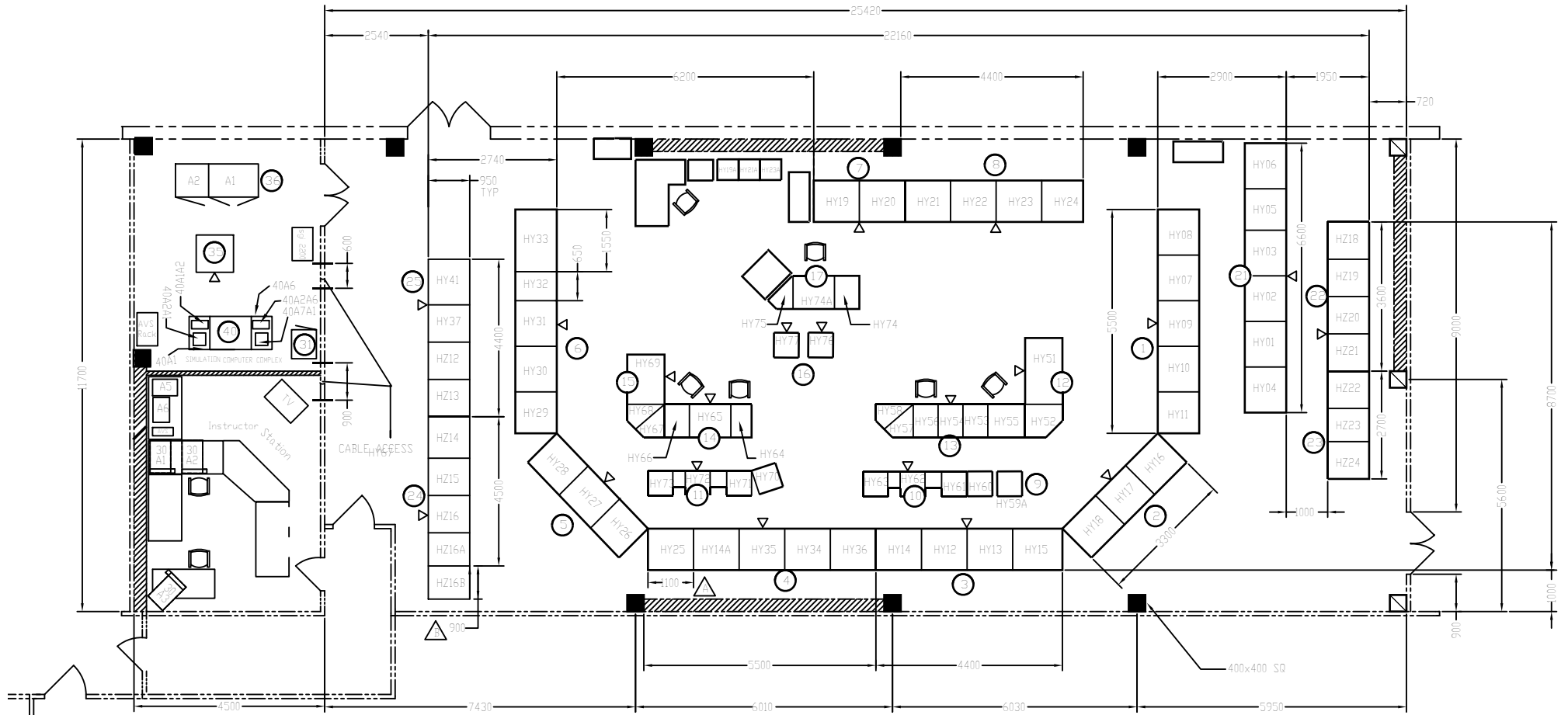
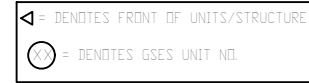
- ▲ DIMENSION 1100 IS TYPICAL FOR PANELS: HY41, HY01 THRU HY31 & HY34 THRU HY36.
- ▲ DIMENSION 900 IS TYPICAL FOR PANELS: HY37, HZ12 THRU HZ16B & HZ18 THRU HZ24.



ПРИЛОЖЕНИЕ 1

Схема на симулаторния комплекс на ПМС-1000

6HY25-1

РЕЗЕРВ L01 1	SE51S21, 22 ZB02.3 SF7 / HB05S SF1 L02 2	SE52S21, 22 ZM02.3 SF7 / HB05S SF2 L03 3	НЕВЪВЕДЕНИ ЗАЩИТИ SA51 L04 4	НЕВЪВЕДЕНИ ЗАЩИТИ SA52 L05 5	НЕВЪВЕДЕНИ ЗАЩИТИ ТГ L06 6	ЛЯВ ЗАБ ИЗБИТ L07 7	НЕВЪВЕДЕНА ЗАЩИТА P(SD)>0,23 kgf/cm ² L08 8	НЕВЪВЕДЕНА ЗАЩИТА ТГ ПО ИЗКЛЮЧЕН GQ L09 9
SE62S01, 02 HB10S SF L10 10	ШКАФОВЕ OVATION ЗАЩИТИ НА ТГ И ТПП неизправност L11 11	БЕРИГИ ЗАЩИТИ ZM02.1 SF15/ HB03S SF3 НЕИЗПРАВНОСТ L12 12	SE63S02 ZB02-5 SF7 / HB03S SF2 L13 13	SE63S01 ZM02-5 SF7 / HB03S SF1 L14 14	РЕЗЕРВ L15 15	ДЕСЕН ЗАБ ИЗБИТ L16 16	РЕЗЕРВ L17 17	РЕЗЕРВ L18 18

6HY25-2

L>2800mm YB10W01 L>2650mm+YD10D01-вкл. L19 19	L>2850mm YB20W01 L>2700mm+YD20D01-вкл. L20 20	L>2800mm YB30W01 L>2650mm+YD30D01-вкл. L21 21	L>2850mm YB40W01 L>2700mm+YD40D01-вкл. L22 22	P < 51kgf/cm² ПРЕД RA11, 12, 13, 14S01 L23 23	L > 375mm в RB60B01+04 L24 24	L>1550/1334/3500 2500mm ПНН 1-4 II предел L25 25	L > 3870 mm RD11(21)W01 II предел гр.А L26 26	L > 3870 mm RD12(22)W01 II предел гр.Б L27 27
P > 0.23kgf/cm² SD11, 12, 13 L28 28	P < 0.5kgf/cm² OC SA - GQ L29 29	P < 13kgf/cm² SE80 (ЛИНИИ НА ЗАЩИТА) L30 30	P < 6.55 kgf/cm² ИЗХОД ИМПЕЛЕР + ХСР L31 31	СРАБОТИЛА АВАРИЙНА ЗАЩИТА НА РЕАКТОРА A3 L32 32	SE20(30,40)S01(02) затворени +SE01(02) незатворен L33 33	SE20,30(40)S01(02) затворени +SE01(02) незатворен L34 34	SE11(12, 13, 14)S01 отворен + SE01(02) незатворен L35 35	1.2 < OI < - 2.0 mm GQ SA10 L36 36
GQ ИЗКЛЮЧЕН ОТ ОСНОВНИ/РЕЗЕРВНИ/ ЗАЩИТИ НА БЛОКА KL9/29 L37 37	F < 140 m³/h SS L38 38	F < 1100 m³/h ST L39 39	НИСКО НИВО в SU51(52)B01 II предел L40 40	SA51, 52 ИЗКЛЮЧЕНИ L41 41	VC11(12,13)D01,02 ИЗКЛЮЧЕНИ L42 42	P > 13 kgf/cm² след SA10 L43 43	РЕЗЕРВ L44 35	SE01 - SE02 > 30% + EXCP L45 45
P_m > 9kgf/cm² (n > 112.5% n _{ном}) СЛЕД ИЗКЛЮЧВАНЕ GQ L46 46	РЕЗЕРВ L47 47	F < 49,15 Hz F > 50,4 Hz L48 48	SE63S02 ИЗБИТ L49 49	SE63S01 ИЗБИТ L50 50	ЗАБ – ИЗБИТ n > 1665 ÷ 1680 min ⁻¹ L51 51	ЗАТВОРЕНИ 2 от 4 SE11(12),13(14)S01 L52 52	SE11, 12, 13, 14S01 ЗАТВОРЕНИ ОТ КУ (БЩУ) L53 53	КЗРП L54 54
10GQ00A01 (HEC7) ИЗКЛЮЧЕН 10GQ ОТ ЕЕС L55 55	РЕЗЕРВ L56 56	РЕЗЕРВ L57 57	РЕЗЕРВ L58 58	РЕЗЕРВ L59 59	ниво над I предел в RH40W01 (RH50W01) + N ≥ 70% L60 60	РЕЗЕРВ L61 61	РЕЗЕРВ L62 62	РЕЗЕРВ L63 63

6HY26-1

“Отказ на ЕМП” L01 1	РЕЗЕРВ L02 2	РЕЗЕРВ L03 3	+39 < OPP ЦНН < -2mm L04 4	+3.2< OPP ЦВН < -2.7 mm L05 5	+ 0.6 < ОИ < -1.4 mm L06 6	Виброскорост > 4.5 mm/s SB11,12,21,22,31,32,41,42; SQ11, 12, 21, 22 SE11,12,13,14 L07 7
2425 < L09 < 2250 mm YB10W01 L08 8	2475 < L09 < 2300 mm YB20W01 L09 9	Т° > 70°С МАСЛО СЛИВ ЛАГЕРИ L10 10	Т° > 60°С ИЗХ. ТРЪБИ SA20,30,40 L11 11	Т° > 90°С SB11,12,13,21,22,31,32,41,42; SQ11, 12, 21, 22 L12 12	ΔТ° > 35°С ГОРЕ - ДОЛУ ПАРОВПУСК SA10 L13 (ВЪТРЕШЕН КОРПУС) 13	ΔТ° > 35°С ГОРЕ - ДОЛУ ПАРОВПУСК SA10 L14 14
2425 < L09 < 2250 mm YB30W01 L15 15	2475 < L09 < 2300 mm YB40W01 L16 16	Промяна на температурата на изход от СПП L17 37	РЕЗЕРВ L18 39	РЕЗЕРВ L19 38	HV70 ÷ 73S ЗЕМЯ ВЕРИГИ 48V РП к. 16.80 М3 L20 17	L > 100 cm SC61B01 L21 18

6HY26-2

вибрации > 200 μm SB11 ÷ 42 SQ11,12 L22 27	вибрации > 150 μm SB11 - 42; SQ11,12 L23 26	виброскорост>7.1mm/s SB11 ÷ 42 SQ11+22 L24 25	РЕЗЕРВ L25 24	ЗАЩИТИ ТГ НЕИЗПРАВНОСТ L26 23	ОТКАЗ ЕХСР ОТКАЗ ДАТЧИЦИ L27 22	SE01(02)S01 В ПОЛОЖЕНИЕ ХСР L28 21	n > 1650 min⁻¹ SA - SQ L29 20	SE61S01(МУТ) НЕОТВОРЕН L30 19
ОТКАЗ АСУТ Ovation HA231÷235 HA212 L31 36	ЕХСР Преход в РМ отказ датчик Р в ГПК L32 35	ОТКАЗ ЕЧ ЕХСР НА 211 L33 34	АСУТ-OVATION НЕИЗПРАВНОСТ L34 33	ОГРАНИЧЕНИЕ НА ТГ ЕХСР не управлява ТГ L35 32	РЪЧНО УПРАВЛЕНИЕ ОТ ЕХСР L36 31	Т° > 100°С SB11 ÷ 42; SQ11 ÷ 22 L37 30	Т° > 100°С изх. тръби SA20, 30, 40 L38 29	Отказ на ОМ L39 28

6HY27-1

РЕЗЕРВ L01 1	РЕЗЕРВ L02 2	РЕЗЕРВ L03 3	ПОВИКВАНЕ КЪМ МЩУ 6RQ45J01 L04 4	HY25 ÷ 36 ИЗКЛЮЧЕН SF L05 5	HY37, 41 ИЗКЛЮЧЕН SF L06 6	РЕЗЕРВ L07 7
Висока Т помпи RL,RN, RM, SC L08 8	РТ УКТС- МЗ L09 9	Повикване УКТС OVATION - МЗ L10 10	НК13S НЕИЗПРАВНОСТ РП ▽16 ⁸⁰ L11 11	НЕИЗПРАВНОСТ КАНАЛИ БЛОКИРОВКИ II К-Р L12 12	РЕЗЕРВ L13 13	ИЗКЛЮЧИЛ ЦИФРОВ РЕГУЛАТОР II К-Р L14 14
ZA03, 05, 07 Сборки УВС к.12.00 МЗ L15 15	ZB06; ZB11,12 АСУТ УКТС OVATION ▽12 ⁰⁰ МЗ L16 16	УКТС М.3 ▽12 ⁰⁰ ZA01,02; ZB03,04,05,10 HW01,02S L17 17	РЕЗЕРВ L18 18	Повикване към GT01J01,02 ▽15 ⁰⁰ М.3 и прибори L19 19	РЕЗЕРВ L20 42	Неизправност БОУ RE10S01,06 RE10J02÷5,7,12 L21 21
RE21J01 ÷ 04 ▽0 ⁰⁰ МЗ L22 22	ПОВИКВАНЕ НА МЩУ ХИДРАЗИН И АМОНИЯК RV20J01-03 L23 23	ПОВИКВАНЕ НА МЩУ АХК HX01÷10, RE10J08 L24 24	SA10J08 (SE91,92D01) ▽3 ⁶⁰ МЗ L25 25	ЦПС – 4 L26 26	ХИДРОАМОТИСЬОРИ НЕИЗПРАВНОСТ РП ▽16 ⁸⁰ L27 27	ИЗКЛЮЧИЛ РЕГУЛАТОР II КОНТУР УКТС L28 28

6HY27-2

18 < RX41Q23 < 9 µSm/cm L29 29	RX32Q02 > 0.3 µSm/cm след RE L30 30	L > 20 cm UL ▽ -3 ⁶⁰ в МЗ L31 31	L > 1500 mm в маслоуловител трансф. площадка L32 32	ВИСОКО НИВО НА ▽ -3 ⁶⁰ в МЗ L33 33	РЕЗЕРВ L34 34	РЕЗЕРВ L35 35
РЕЗЕРВ L36 36	T° > 22°C АСУТ ▽12 ⁰⁰ МЗ L37 37	UV14D01 ÷ 04 НЕИЗПРАВНОСТ РП ▽16 ⁸⁰ L38 38	НЕИЗПРАВНОСТ UX11,21,31J01,02 к. 0.00 МЗ L39 39	Повикване към МЩУ TRC L40 40	Променено Р UM вход – изход МЗ L41 41	UM10J01 ÷ 08 ▽0 ⁰⁰ МЗ L42 20
РЕЗЕРВ L43 43	НИСКО НАЛЯГАНЕ НА СМАЗВАЩА ВОДА VB11÷16D01 L44 44	РЕЗЕРВ L45 49	РЕЗЕРВ L46 48	UV66D01 НЕИЗПРАВНОСТ L47 47	UV66D02 ÷ 06 НЕИЗПРАВНОСТ L48 46	UM30J01 ▽ - 3 ⁶⁰ МЗ L49 45
РЕЗЕРВ L50 73	РЕЗЕРВ L51 74	РЕЗЕРВ L52 50	UV70D01 НЕИЗПРАВНОСТ L53 51	UV70D02 НЕИЗПРАВНОСТ L54 52	UV66D07 НЕИЗПРАВНОСТ L55 53	UM40J01 ▽17 ⁰⁰ МЗ L56 54

6HY27-3

НИВО В СТУДЕН КАНАЛ L57 63	P > 71 kgf/cm ² ГПК L58 62	P _м < 0.7 kgf/cm ² ПРЕД SN10D01 L59 61	P _м < 7 kgf/cm ² ИЗХОД НА ИМПЕЛЕРА L60 60	НЕИЗПРАВНОСТ ПАНЕЛИ HK09,09A,10,18,20S L61 59	P > 0,13 kgf/cm ² В SD11(12,13) L62 58	P _м < 0.9 kgf/cm ² OC SA - GQ L63 57	P _м < 0.7 kgf/cm ² OC SA - GQ L64 56	n < 600 min ⁻¹ SA - GQ L65 55
SA20(30,40)S01(02) ЗАТВОРЕН ПРИ НЕЗАТВОРЕН SE01,02 L66 72	RC11,(12)S01,(02) НЕЗАТВОРЕН L67 71	НЯМА ОПЕР. НАПРЕЖ. ВЪВ ВЕРИГИ БРУ - К L68 70	ПОТОП SA - GQ НА ВПУ L69 69	L > 100 mm RB10 ÷ 40B01 L70 68	РЕЗЕРВ L71 67	P > 11.5 kgf/cm ² след SA10 L72 66	РЕЗЕРВ L73 65	L > 2800 mm ТРЪБОПРОВОДИ СЛИВ СЕПАРАТ ОТ RB60 L74 64

6HY28-1

РЕЗЕРВ L01 19	РЕЗЕРВ L02 20	РЕЗЕРВ L03 21	РЕЗЕРВ L04 22	РЕЗЕРВ L05 23	РЕЗЕРВ L06 24	РЕЗЕРВ L07 25	РЕЗЕРВ L08 26	РЕЗЕРВ L09 27
-------------------------	-------------------------	-------------------------	-------------------------	-------------------------	-------------------------	-------------------------	-------------------------	-------------------------

6HY28-2

L < 50 mm SD11Z01 L10 1	L < 50 mm SD12Z01 L11 2	L < 50 mm SD13Z01 L12 3	1700 < L < 1300 mm SD11,12,13 L13 4	VC11D01(02) НЕИЗПРАВНОСТ L14 5	VC12D01(02) НЕИЗПРАВНОСТ L15 6	VC13D01(02) НЕИЗПРАВНОСТ L16 7	VB11(12,13,14,15,16)D01 НЕИЗПРАВНОСТ L17 8	T > 100°C RC11,12S03 + 08 L18 9
L < 50 mm SD11Z02 L19 10	L < 50 mm SD12Z02 L20 11	L < 50 mm SD13Z02 L21 12	НЕУСПЕШЕН АВР НА ПОК L22 13	P < 1.7 kgf/cm ² НА ВХОД НА ПОК-II L23 14	НИВО В КАНАЛА < 29m VB L24 15	НИВО В КАНАЛА < 30m VC L25 16	SD31(32,33,34)D01 ВКЛЮЧЕНИ L26 17	P < 16 kgf/cm ² ВПРЪСК В RC11,12S03 +08 L27 18

6HY29-1

РЕЗЕРВ L01 19	РЕЗЕРВ L02 20	РЕЗЕРВ L03 21	РЕЗЕРВ L04 22	РЕЗЕРВ L05 23	РЕЗЕРВ L06 24	РЕЗЕРВ L07 25	РЕЗЕРВ L08 26	РЕЗЕРВ L09 27
-------------------------	-------------------------	-------------------------	-------------------------	-------------------------	-------------------------	-------------------------	-------------------------	-------------------------

6HY29-2

P < 6.75 kgf/cm² RM11,12,13D01 - НАПОР L10 1	P < 1.5 kgf/cm² RM41,42,43D01 СМУК. ТР-Д L11 2	RN72(73,74)D01 ВКЛЮЧЕНА РЕЗЕРВНА ПОМПА L12 3	P < 15 kgf/cm² RM41, 42, 43D01 НАПОР L13 4	RH50W01 ИЗКЛЮЧЕН L14 5	RH40W01 ИЗКЛЮЧЕН L15 6	RN52,53,54D01 RN72,73,74D01 ИЗКЛЮЧЕНИ L16 7	L > 1070 mm RH50W01 RN52(53,54)D01 ВКЛЮЧЕНА РЕЗЕРВ. ПОМПА L17 8	P < 12 kgf/cm² RN52,53,54D01 L18 9
L > 700 mm RH71(72,73)W01 L19 10	L > 800 mm (I предел) RH71(72,73)W01 L20 11	L > 780 mm (I предел) RH61(62)W01 L21 12	L > 600 mm RH61(62)W01 L22 13	L > 1215 mm (I предел) RH50W01 L23 14	L > 1215 mm (I предел) RH40W01 L24 15	L > 870 mm RH50W01 L25 16	L > 870 mm RH40W01 L26 17	P < 12 kgf/cm² RN72,73,74D01 L27 18

6HY30-1

РЕЗЕРВ L01 19	РЕЗЕРВ L02 20	РЕЗЕРВ L03 21	РЕЗЕРВ L04 22	РЕЗЕРВ L05 23	РЕЗЕРВ L06 24	РЕЗЕРВ L07 25	РЕЗЕРВ L08 26	РЕЗЕРВ L09 27
-------------------------	-------------------------	-------------------------	-------------------------	-------------------------	-------------------------	-------------------------	-------------------------	-------------------------

6HY30-2

СПОМАГАТЕЛНИ СИСТЕМИ SA51,52 АВР+ UA13 L10 1	СПОМАГАТЕЛНИ СИСТЕМИ SA,GQ АВР L11 2	L > 1700 mm RT30B02 L12 3	RQ20S01 ÷ 12 ОТВОРЕН L13 4	RQ10S01 ÷ 10 ОТВОРЕН L14 5	L < 1200 mm RL21B01 L15 6	L < 1200 mm RL22B01 L16 7	P < 3 kgf/cm ² UA L17 8	P > 10,2 kgf/cm ² VB81,82,83D01 изход L18 9
L > 1850 mm RT30 L19 10	L < 800 mm RR20W01 L20 11	T > 55°C изход RR20W01 L21 12	F > 160 t/h RQ30 L22 13	P < 4.2 kgf/cm ² VC21,22D11 изход L23 14	L < 2000 mm RL21B01 L24 15	L < 2000 mm RL22B01 L25 16	L > 3350 mm RL21,22B01 (ПРЕЛИВ) L26 17	ПОТВЪРДИ ПРЕХВ. НА КС-II СТ.,КС-I СТ. КЪМ ДЕАРАТОРА L27 18

6НУ31-1

НЕВКЛЮЧИЛА SS11(12)D01 ПРИ УСЛОВИЯ ЗА АВР L01 9	ВИСОКО /НИСКО НИВО В SS10B01 L02 8	$F < 170 \text{ m}^3/\text{h}$ SS (I ПРЕДЕЛ) L03 7	НИСКО НАЛЯГАНЕ НА ДЕСТИЛАТА L04 6	НИСКО ОТНОС.СЪПРОТИВЛЕНИЕ НА ДЕСТИЛАТА L05 5	РЕЗЕРВ L06 4	10GQ пад $\text{H}_2 > 0.1 \text{ kgf/cm}^2$ за 10min L07 3	10GQ H2 II предел 9,10 лагери неутрала изводи 24kV L08 2	НЕИЗПРАВНОСТ НА VE11,VE12, VE13 L09 1
НЕВКЛЮЧИЛА ST11(12)D01 ПРИ УСЛОВИЯ ЗА АВР L10 18	Високо/Ниско ниво в ST40B01 L11 17	$F < 1650 \text{ m}^3/\text{h}$ ST (I ПРЕДЕЛ) L12 16	НИСКО НАЛЯГАНЕ НА ОХЛАЖДАЩА ВОДА ST L13 15	РЕЗЕРВ L14 14	РЕЗЕРВ L15 13	10GQ $P \text{ H}_2 < 5.3 \text{ kgf/cm}^2$ $> 5.7 \text{ kgf/cm}^2$ L16 12	РЕЗЕРВ L17 11	НЕИЗПРАВНОСТ НА МЩУ VB51,52N01 L18 10
РЕЗЕРВ L19 27	РЕЗЕРВ L20 26	Ниско ниво в SU60B01 L21 25	SU64S03 ЗАТВОРЕНА L22 24	ВИСОКО НИВО В SU60B01 L23 23	GQ ВИСОКА ВЛАЖНОСТ НА ВОДОРОДА L24 22	НИСКА ЧИСТОТА на H ₂ L25 21	10GQ H2 I ПРЕДЕЛ 9, 10 ЛАГЕРИ SS СИСТЕМА L26 20	ТЕЧНОСТ В КОРПУСА НА ГЕНЕРАТОРА L27 19
Ниско L в SU51B01 I или II предел L28 36	Ниско L в SU52B01 I или II предел L29 35	НИСКО НАЛЯГАНЕ МАСЛО НА УПЛЪТНЕНИЕ L30 34	10GQ SU-H2 $0.9 < \Delta P < 0.5$ L31 33	ИЗМЕНЕНИЕ НА ВАКУУМА В БАК А В О М L32 32	ВИСОКО /НИСКО НИВО В бак А В О М L33 31	ТЕЧНОСТ В SU10B03 L34 30	ИЗКЛЮЧЕНИ SU64,71,72D01 ПРИ P(GT) $> 0.6 \text{ kgf/cm}^2$ В КОРП. НА ГЕН. L35 29	10GQ Висока Т GT,GE,ST,SS,SU L36 28

6НУ31-2

$A > 7.4 \text{ E}4 \text{ Vq/m}^3$ UM L37 1	ВЕРИГИ УПРАВЛЕНИЕ I СБ (SC, SU) НЕИЗПРАВНОСТ L38 2	ВЕРИГИ УПРАВЛЕНИЕ II СБ (SC, SU) НЕИЗПРАВНОСТ L39 3	ВЕРИГИ УПРАВЛЕНИЕ III СБ (SC, SU) НЕИЗПРАВНОСТ L40 4	ВИСОКА ТЕМПЕРАТУРА НА ЛАГЕРИТЕ ПОМПИ SE80D01+03 L41 5	АВАРИЙНО ИЗКЛЮЧИЛ ДВИГАТЕЛ ИЛИ РЕГУЛАТОР L42 6	$P_M < 1.5 \text{ kgf/cm}^2$ SU91D11(21) L43 7	$P_M < 1.5 \text{ kgf/cm}^2$ SU91D31(41) L44 8	$P_M < 1.5 \text{ kgf/cm}^2$ SU91D51(61) L45 9
$L < 1300 \text{ mm}$ SC20B01 L46 10	$\Delta P < 1 \text{ kgf/cm}^2$ UM - RH42 L47 11	$P < 80 \text{ kgf/cm}^2$ SC91(92)D01 НАПОР L48 12	$L < 1240 \text{ mm}$ SC10B01 L49 13	$45^\circ\text{C} < T^\circ < 38^\circ\text{C}$ СЛЕД SC11,12,13,14W01 L50 14	неизправна система UA13 L51 15	НИСКО НИВО В SU91B01 L52 16	НИСКО НИВО В SU91B02 L53 17	НИСКО НИВО В SU91B03 L54 18

6НУ32-1

РЕЗЕРВ L01 121	РЕЗЕРВ L02 117	РЕЗЕРВ L03 118	10GC01, 02, 6BT01, 02, BT07, 08 повишена концентрация на газове (аларма) L04 119	10GC01, 02, 6BT01, 02, BT07, 08 пределна концентрация на газове (аварийен сигнал) L05 120
10GC01/02 "ЗЕМЯ" НА СТРАНА 24kV L06 28	10GC01/02 t° масло >65°C L07 42	10GC01/02 НИСКО (ВИСОКО) НИВО НА МАСЛО L08 43	10GC01/02 понижен разход на охл. вода <150t/h (VB) <216t/h (VC) L09 60	10GC01/02 – ЛИПСВА ОПЕРАТИВНО НАПРЕЖЕНИЕ В ШКАФА НА 6VC71,72S02 L10 1
10GC02 ГАЗОВА ЗАЩИТА L11 40	10GC02 СРАБОТИЛ ОТСЕЧЕН КЛАПАН 6SV20S35 L12 12	10GC02 НЕИЗПРАВНОСТ В ОХЛАЖДАНЕТО L13 23	10GC02 изключено охлаждане, пуск прогр. реле L14 10	10GC02 включена 6SV21D01 (ПРП) L15 61
10GC01 ГАЗОВА ЗАЩИТА L16 39	10GC01 СРАБОТИЛ ОТСЕЧЕН КЛАПАН 6SV10S35 L17 11	10GC01 НЕИЗПРАВНОСТ В ОХЛАЖДАНЕТО L18 22	10GC01 изключено охлаждане, пуск прогр. реле L19 9	10GC01 включена 6SV11D01 (ПРП) L20 41

6НУ32-2

РЩБ-6 липсва U опер. на защити група А L21 24	РЩБ-6 липсва U опер. на защити група В L22 25	БГТ-10 НЕИЗПРАВНОСТ НАПРЕЖЕНОВИ ВЕРИГИ L23 29	РЕЗЕРВ L24 52	6НУ39 ИЗКЛЮЧИЛ АВТОМАТ L25 26
РЩБ-6 ∇8 ⁴⁰ ИЗКЛЮЧИЛ АВТОМАТ 6HE08÷6HE13 L26 20	10GQ ИЗКЛЮЧВАНЕ ОТ ЗАЩИТИ ОТ ПРЕТОВАРВАНЕ F12, F22 L27 4	10GQ ИЗКЛЮЧВАНЕ ОТ ДИСТАНЦ. ЗАЩИТА F12, F22 L28 5	10GQ СРАБОТИЛ ОГРАНИЧИТЕЛ ОТ НЕДОВЪЗБУЖДАНЕ L29 14	10GQ СРАБОТИЛ ОГРАНИЧИТЕЛ ОТ ПРЕВЪЗБУЖДАНЕ L30 8
РЕЗЕРВ L31 36	6 Z H 7 0 J 1 0 неизправност L32 37	10GQ ВЪЗБУЖДАНЕ АВАРИЙНО ПРЕМИНАВАНЕ НА РЪЧНО УПРАВЛЕНИЕ L33 13	10GQ "земя" в ротор F12 L34 6	6HEC7 10GQ00A01 -повреда L35 7
БГТ-10 изключване от защити група А L36 27	БГТ-10 изключване от защити група В L37 19	РЩБ-6 ∇8 ⁴⁰ ПОВРЕДА В РЕЛЕЙНИ ПАНЕЛИ 6HE01÷6HE05 L38 32	РЩБ-6 ОТВОРЕНА ВРАТА НА ПАНЕЛИ ∇8 ⁴⁰ L39 33	RF максимално въздействие L40 34

6НУ32-3

10GQ ПРЕТОВАРВАНЕ НА РОТОРА F15 L41 3	Повикване към 6 G T 0 1 J 0 5 L42 18	Изгоряла 1 група предпазители в едно рамо на 10VS L43 15	Изгорели 2 групи предпазители в едно рамо на 10VS L44 16	РЕЗЕРВ L45 17
6HEC7 10GQ00A01 - БЛОКИРАН L46 2	РЩБ-6 ∇8 ⁴⁰ ПОВРЕДА В РЕЛЕЙНИ ПАНЕЛИ 6HE06÷6HE13 L47 21	10GQ ПОВРЕДА В ПАНЕЛИ ВЪЗБУЖДАНЕ 6HE14÷18 L48 35	6HEC7 ИЗКЛЮЧИЛ АВТОМАТ ОПЕРАТИВНО НАПРЕЖЕНИЕ L49 30	10GQ ЗАГУБА НА ВЪЗБУЖДАНЕ L50 38

6НУ33-1

10GQ00A01 НИСКО НАЛЯГАНЕ ДОПЪЛВАНЕ НА SF ₆ ПОВРЕДА В МАСЛЕНА СИСТЕМА. L01 31	6HEC7 – 10GQ00B01, 10GQ00J01 - ПОВРЕДА L02 83	6GZ ПРЕТОВАРВАНЕ L03 110	6GZ НЕИЗПРАВНОСТ L04 111	6BZ ПОВИКВАНЕ L05 112	6BA, 6BB ПОВИКВАНЕ 6НВ03 L06 113	6BC, 6BD ПОВИКВАНЕ 6НВ04 L07 114	СИМУЛИРАН ПРЕКЪСВАЧ ЗА АВР 6BA/6BB ПРОМЕНЕН ПРИОРИТЕТ ЗА АВР L08 115	СИМУЛИРАН ПРЕКЪСВАЧ ЗА АВР 6BC/6BD ПРОМЕНЕН ПРИОРИТЕТ ЗА АВР L09 116	РЕЗЕРВ L10 125	РЕЗЕРВ L11 126	РЕЗЕРВ L12 127	РЕЗЕРВ L13 128
10GQ ТОКОПРОВОД 24 KV ВОДА В ТОКОПРОВОДА ▽5 ¹⁰ СПР-РЩБ-6 L14 84	ВОДА В ТОКОПРОВОД 24KV ▽10 ⁵⁰ L15 87	BT07, 08 ПОВИКВАНЕ НА ТРАНСФОРМАТОРНА ПЛОЩАДКА L16 99	6BL+6BP ПОВИКВАНЕ НА 6ED50 6ED40 L17 100	6BL, 6BM ПОВИКВАНЕ L18 101	6BN, 6BP ПОВИКВАНЕ L19 102	6BL, 6BM ПРЕТОВАРВАНЕ L20 103	6BN, 6BP ПРЕТОВАРВАНЕ L21 104	АВР НА 6DB01 L22 105	BT07, 08 ИЗКЛЮЧВАНЕ ОТ НИСКО НАЛЯГАНЕ НА SF ₆ В КЛ 220kV L23 106	BT07, 08 НИСКО НАЛЯГАНЕ НА SF ₆ В КЛ 220kV L24 107	6GZ – РАБОТИ L25 108	РЕЗЕРВ L26 109
6QD03, 04 НЕВКЛЮЧЕНИ L27 66	6QD03, 04 АВАРИЙНО ИЗКЛЮЧЕНИ L28 64	BT07, 08 ИЗКЛ. ОТ ОСНОВНИ ЗАЩИТИ L29 91	BT07, 08 ИЗКЛ. ОТ РЕЗЕРВНИ ЗАЩИТИ L30 92	BT07, 08 ИЗКЛ. ОТ ДЗО L31 93	BT07, 08 ГАЗОВА ЗАЩИТА ИЗКЛЮЧВАНЕ L32 94	BT07, 08 НИСКО НИВО НА МАСЛОТО - СИГНАЛ L33 95	BT07, 08 ВИСОКА t 92°C - ИЗКЛЮЧВАНЕ L34 96	BT07, 08 ВИСОКА T° - СИГНАЛ L35 97	BT07, 08 ПОВРЕДА В ОХЛАЖДАНЕТО L36 98	BT07, 08 ГАЗОВО РЕЛЕ СИГНАЛ L37 90	РЕЗЕРВ L38 123	РЕЗЕРВ L39 124
6QD01, 02 НЕВКЛЮЧЕНИ L40 65	6QD01, 02 АВАРИЙНО ИЗКЛЮЧЕНИ L41 63	6QD01, 02- НЕИЗПРАВНОСТ НИСКО НАЛЯГАНЕ ОХЛ. ВОДА ЗА ЛАГЕРИ QD L42 82	6LA01+13 ПОВИКВАНЕ L43 55	ПОВИКВАНЕ 6НВ02 ИЗКЛЮЧИЛ АВТОМАТ ▽3 ⁶⁰ L44 48	6LM01+21 ПОВИКВАНЕ 6НВ02 ИЗКЛЮЧИЛ АВТОМАТ L45 53	6DM01,02,05,0 6,10-13 ПОВИКВАНЕ L46 54	6LM22,23 ▽12 ⁰⁰ ПОВИКВАНЕ L47 56	6DM03,04,07,0 8 ПОВИКВАНЕ ▽3 ⁶⁰ L48 57	6DA01+13 ПОВИКВАНЕ ▽16 ⁸⁰ L49 58	РЕЗЕРВЕН ТРАНСФОРМАТОР ИЗТИЧАНЕ НА МАСЛО L50 88	РЕЗЕРВ L51 89	РЕЗЕРВ L52 122

6НУ33-2

6BT02 ПРЕТОВАРВАНЕ L53 78	6BC, 6BD "ЗЕМЯ" 6kV L54 49	6BC, 6BD ПОВИКВАНЕ L55 50	6BC, 6BD АВР РАБОТИ L56 79	6CM, 6CN, 6DW01 ПОВИКВАНЕ L57 51	6DX01 ПОВИКВАНЕ L58 47	РЕЗЕРВ L59 67	РЕЗЕРВ L60 59	Наличие на SF ₆ Кота 3 ⁶⁰ L61 75	6DA14+17 ПОВИКВАНЕ L62 68	6EA50 ИЗКЛЮЧЕН 6UV93D01 L63 62	СРАБОТИЛ ФОГ-1000 L64 85	6BU10 ЕДНОФАЗНО К.С. СТРАНА 0,4 kV L65 86
6BT01 ПРЕТОВАРВАНЕ L66 73	6BA, 6BB "ЗЕМЯ" 6kV L67 44	6BA, 6BB ПОВИКВАНЕ L68 45	6BA, 6BB АВР РАБОТИ L69 74	6CA, 6CB, 6DV01 ПОВИКВАНЕ L70 46	6BU01+04 6BU19,21,22- 1,2 ПРЕТОВАРВАНЕ L71 77	АБП-МЗ ▽3 ⁶⁰ T° > 28°C L72 76	6АБП 50 НЕИЗПРАВНОСТ L73 69	6FE50, 6FF НЕИЗПРАВНОСТ L74 70	6EE50 "ЗЕМЯ" L75 71	РЕЗЕРВ L76 72	6BU10 ПРЕТОВАРВАНЕ L77 80	6BU10 ЛИПСВА U ОТ 5BC L78 81

6HY34-1

+1<OI <- 0.8 mm SA51 L01 1	P > 0.6kgf/cm² SD51 L02 2	P < 36kgf/cm² RL41D01 НАПОР L03 3	n > 3850min⁻¹ SA51 L04 4	P_м<0.6kgf/cm² SC51 – OC SA51 L05 5	P_м<9 kgf/cm² в линията за защита SA51 L06 6	P_м< 1kgf/cm² пред лагери RL41D01 забрана пуск SA51 L07 7	ΔP>0.15 kgf/cm² SC51N01(02,03) L08 8	РЕЗЕРВ L09 9
ΔP(P-Ps) < 1.3 kgf/cm² RL31D01 СМУК. ТР-Д L10 10	P<12kgf/cm² RL41D01 СМУК. ТР-Д L11 11	P>120kgf/cm² RL41D01 НАПОР L12 12	F > 4500 t/h RL41D01 L13 13	P>12kgf/cm² разтоварващ барабан RL41D01 L14 14	P_м<7kgf/cm² SC51D41,42 НАПОР L15 15	P_м<0.3 kgf/cm² ПРЕД РЕДУКТОРА L16 16	ВИСОКА ТЕМПЕРАТУРА НА ЛАГЕРИТЕ И МАСЛО СЛЕД ТЯХ ТПП – 1 L17 17	P ≤5.8 kgf/cm² след RQ51S01 L18 18
						ВИБРОСКОРОСТ >4.5mm/s ЛАГЕРИ SA51,RL41D01 L19 19	P_м<0.6kgf/cm² ПРЕД ЛАГЕРИ RL41D01 ЗАБРАНА SE51D11 L20 20	ΔP>0.6 kgf/cm² ΔP<0.1 kgf/cm² RF L21 21
						P_м< 9kgf/cm² SC51D41,42 НАПОР L22 22	SA51 ЗАБРАНА ЗА ПУСК L23 23	SA51 СПРЯНА ОТ КУ (БЩУ) L24 24
						ВИБРОСКОРОСТ>7.1 mm/s ЛАГЕРИ SA51,RL41D01 L25 25	RW51D11,21 ИЗКЛЮЧЕНИ L26 26	L > 550 mm SD51 T°изх.тр>55°C L27 27
						НЕСЪОТВЕТСТВИЕ М/У КИ SE51S01 и КИ ПРИВОД SE51S01 L28 28	RL51D01 ИЗКЛЮЧЕНА L29 29	+0.7mm<OI OI<-0.7 mm RL41 L30 30

6HY35-1

+1<OI<- 0.8mm SA52 L01 1	P > 0.6kgf/cm² SD52 L02 2	P < 36kgf/cm² RL42D01 НАПОР L03 3	n > 3850min⁻¹ SA52 L04 4	P_M < 0.6kgf/cm² SC52 - OC SA52 L05 5	P_M < 9 kgf/cm² в линията за защита SA52 L06 6	P_M < 1kgf/cm² пред лагери RL42D01 забрана пуск SA52 L07 7	ΔP>0.15 kgf/cm² SC52N01(02,03) L08 8	РЕЗЕРВ L09 9
ΔP(P-Ps) < 1.3kgf/cm² RL32D01 СМУК. ТР-Д L10 10	P < 12kgf/cm² RL42D01 СМУК. ТР-Д L11 11	P > 120kgf/cm² RL42D01 НАПОР L12 12	F > 4500 t/h RL42D01 L13 13	P > 12kgf/cm² разтоварващ барабан RL42D01 L14 14	P_M < 7kgf/cm² SC52D41,42 НАПОР L15 15	P_M < 0.3 kgf/cm² ПРЕД РЕДУКТОРА L16 16	ВИСОКА ТЕМПЕРАТУРА НА ЛАГЕРИТЕ И МАСЛО СЛЕД ТЯХ НА ТПП – 2 L17 17	P ≤ 5.8 kgf/cm² след RQ52S01 L18 18
						ВИБРОСКОРОСТ >4.5mm/s ЛАГЕРИ SA52,RL42D01 L19 19	P_M < 0.6kgf/cm² ПРЕД ЛАГЕРИ RL42D01 ЗАБРАНА SE52D11 L20 20	0.6 < ΔP < 0.1kgf/cm² RF L21 21
						P_M < 9kgf/cm² SC52D41,42 НАПОР L22 22	SA52 ЗАБРАНА ЗА ПУСК L23 23	SA52 СПРЯНА ОТ КУ (БЩУ) L24 24
						ВИБРОСКОРОСТ >7.1 mm/s ЛАГЕРИ SA52,RL42D01 L25 25	RW52D11,21 ИЗКЛЮЧЕНИ L26 26	L > 550 mm SD52 T°изх.тр >55°C L27 27
						НЕСЪОТВЕТСТВИЕ М/У КИ SE52S01 и КИ ПРИВОД SE52S01 L28 28	RL52D01 ИЗКЛЮЧЕНА L29 29	+0.7mm<OI OI<-0.7 mm RL42 L30 30

6HY36-1

АВТОМАТ ЗА БЕЗОПАСНОСТ SA51 ИЗПИТНО ПОЛОЖЕНИЕ L01 1	SE51S03(04) ЗАТВОРЕН L02 2	АВТОМАТ ЗА БЕЗОПАСНОСТ SA52 ИЗПИТНО ПОЛОЖЕНИЕ L03 3	SE52S03(04) ЗАТВОРЕН L04 4	$\Delta P(P-P_s) < 1.2\text{kgf/cm}^2$ RL51D01 смук. тр-д. L05 5	$\Delta P(P-P_s) < 1.2\text{kgf/cm}^2$ RL52D01 смук. тр-д. L06 6	РЕЗЕРВ L07 7	$P > 0.2\text{kgf/cm}^2$ SD51 L08 8	$P > 0.2\text{kgf/cm}^2$ SD52 L09 9
RD11,21W01 ИЗКЛЮЧЕНИ L10 17	$L > 154(276)\text{cm}$ (I предел) RD11(21)W01 L11 18	$L > 104(226)\text{cm}$ RD11(21)W01 L12 16	$L < 41(150)\text{cm}$ RD11(21)W01 L13 15	РЕЗЕРВ L14 14	$L < 41(150)\text{cm}$ RD12(22)W01 L15 13	$L > 104(226)\text{cm}$ RD12(22)W01 L16 12	$L > 154(276)\text{cm}$ (I предел) RD12(22)W01 L17 11	RD12,22W01 ИЗКЛЮЧЕНИ L18 10

6HY14A-1

2425 < L05 < 2250 mm YB10W01	L19 > 2450mm YB10W01	2475 < L05 < 2300 mm YB20W01	L19 > 2500mm YB20W01	2425 < L05 < 2250 mm YB30W01	L19 > 2450mm YB30W01	2475 < L05 < 2300 mm YB40W01	L19 > 2500mm YB40W01	P < 64 kgf/ cm ² RL
L01 78	L02 79	L03 76	L04 77	L05 73	L06 85	L07 71	L08 84	L09 75
НИСКО/ВИСОКО НАЛЯГАНЕ в UT40B01	Ниска Т UT40B01 Висока Т US41D01	US41D01 НЕИЗПРАВНОСТ	RL71-74S02,04 ИЗКЛЮЧЕН ОТ АВТОМАТИЧЕН РЕЖИМ	Неизправ. управление на аналог. интерфейс RL71 +74S02,04	ОТКАЗ УПРАВЛЕНИЕ НА АНАЛОГ. ИНТЕРФЕЙС RL71 +74S02,04	РЕЗЕРВ	РЕЗЕРВ	n > 3500 min ⁻¹ SA51,52
L10 83	L11 81	L12 82	L13 80	L14 72	L15 74	L16 87	L17 88	L18 86

2475 < L05 < 2300 mm YB40W01	Неизправ. управление на аналог. интерфейс RL71 +74S02,04	2425 < L05 < 2250 mm YB30W01	ОТКАЗ УПРАВЛЕНИЕ НА АНАЛОГ. ИНТЕРФЕЙС RL71 +74S02,04	P < 64 kgf/ cm ² RL	2475 < L05 < 2300 mm YB20W01	L19 > 2500mm YB20W01	2425 < L05 < 2250 mm YB10W01	L19 > 2450mm YB10W01
L01 71	L02 72	L03 73	L04 74	L05 75	L06 76	L07 77	L08 78	L09 79
RL71-74S02,04 ИЗКЛЮЧЕН ОТ АВТОМАТИЧЕН РЕЖИМ	Ниска температура в UT40B01 Висока температура	US41D01 НЕИЗПРАВНОСТ	НИСКО/ВИСОКО НАЛЯГАНЕ в UT40B01	L19 > 2500mm YB40W01	L19 > 2450mm YB30W01	РЕЗЕРВ	РЕЗЕРВ	n > 3500 min ⁻¹ SA51,52
L10 80	L11 81	L12 82	L13 83	L14 84	L15 85	L16 87	L17 88	L18 86

6HY25-1

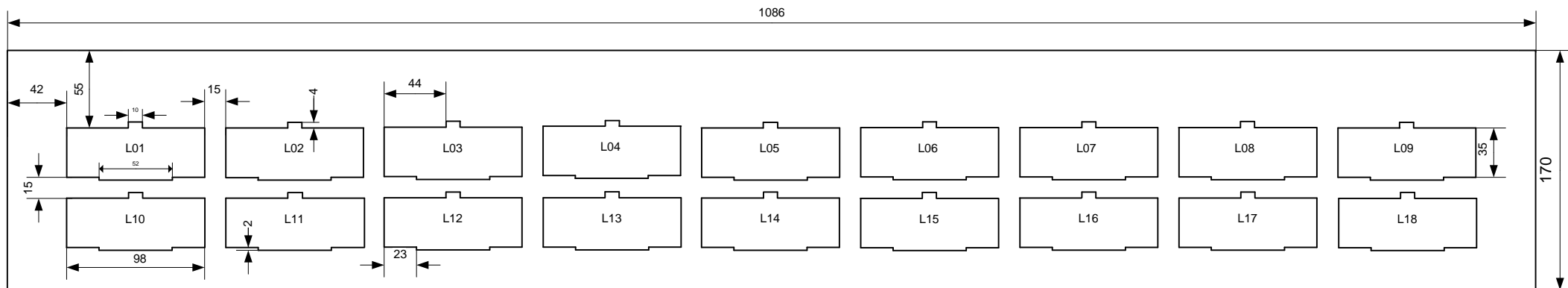

6HY25-2

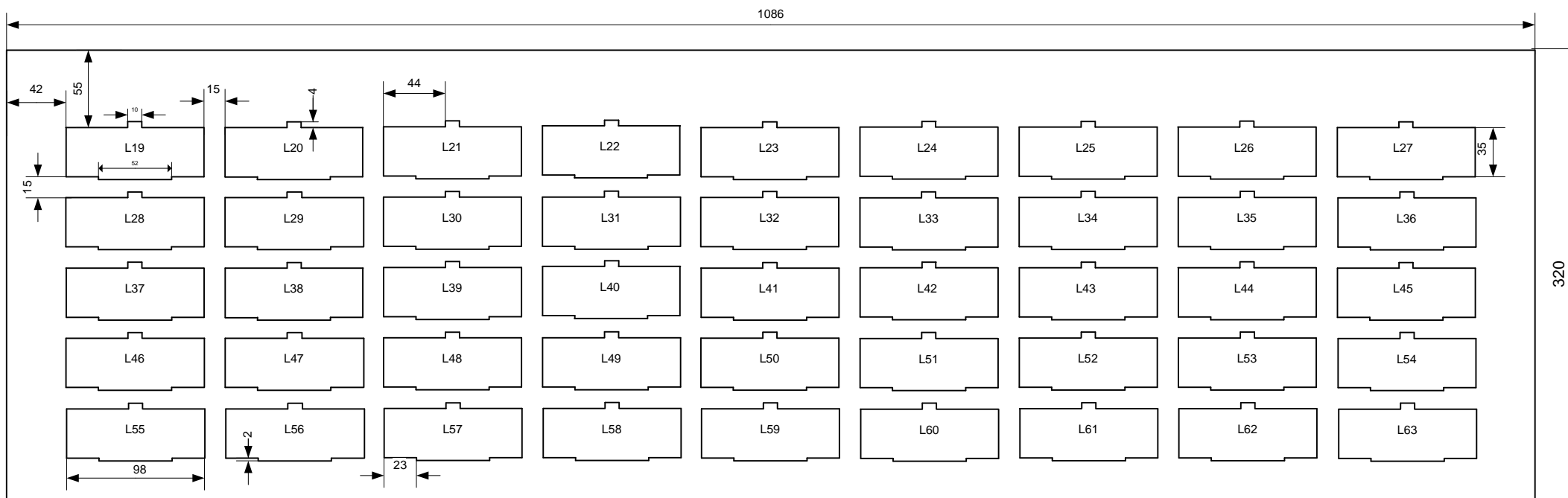

6HY26-1

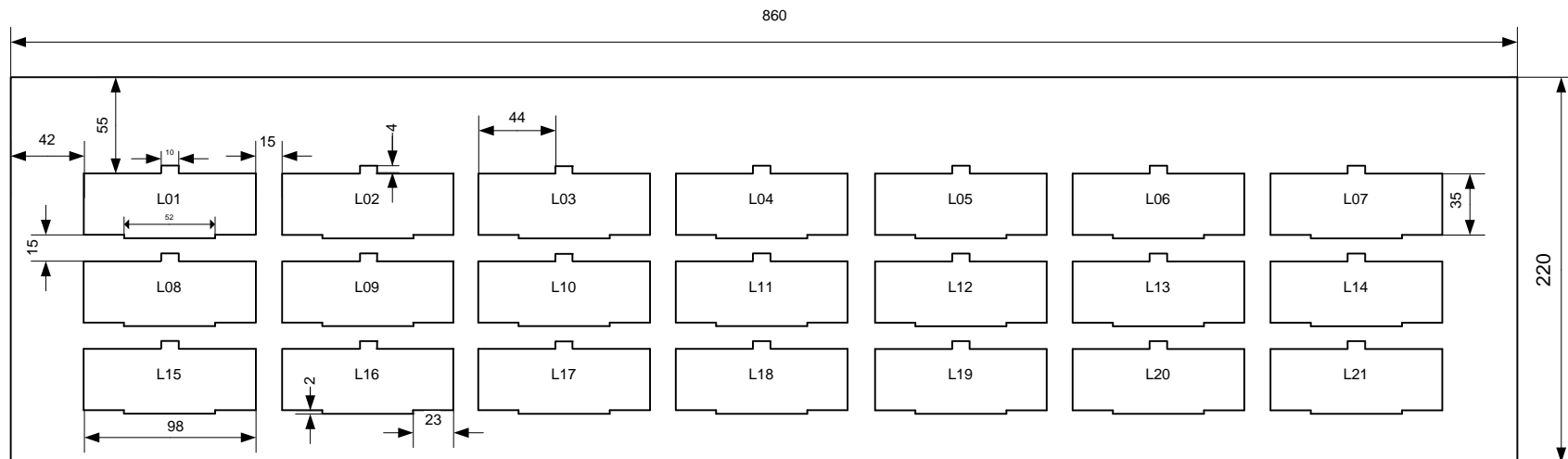

6HY26-2

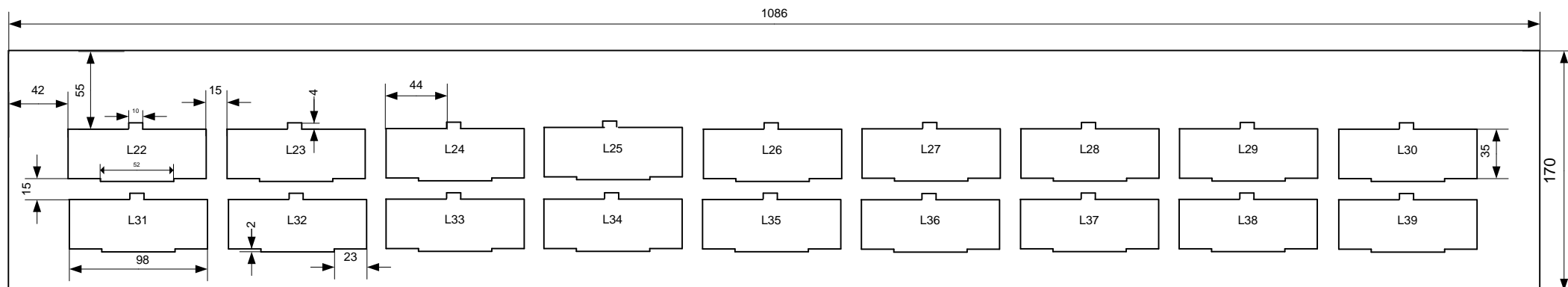

6HY27-1(6HY27-2)

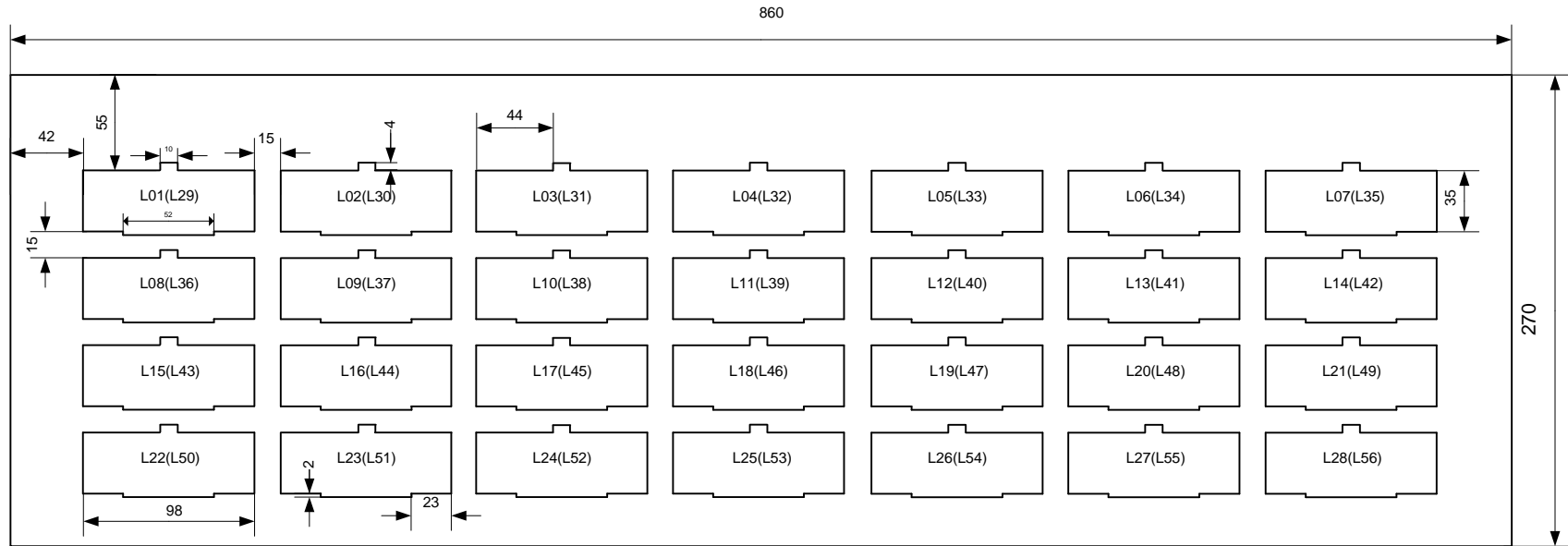

6HY27-3

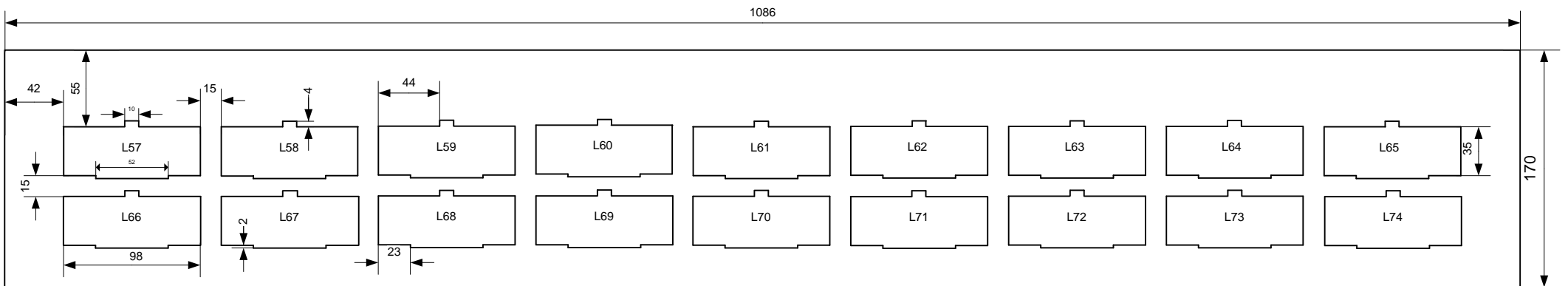

6HY28-1

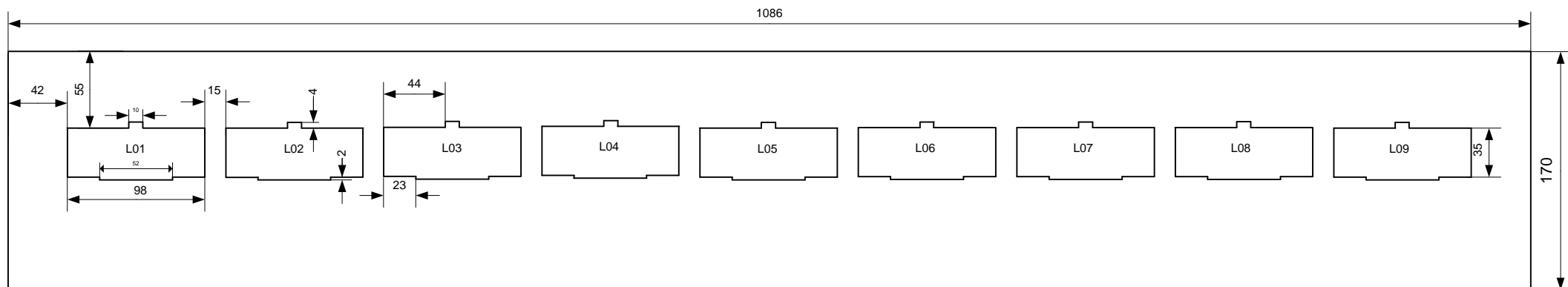

6HY28-2

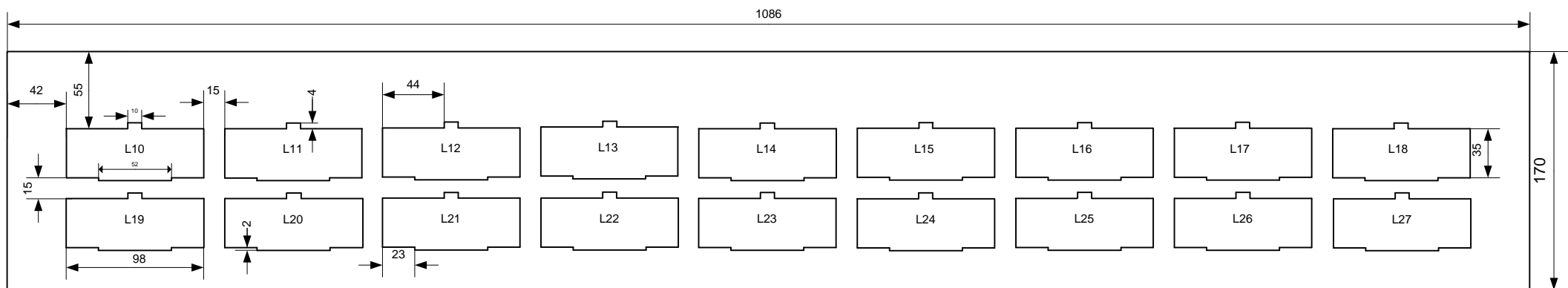

6HY29-1

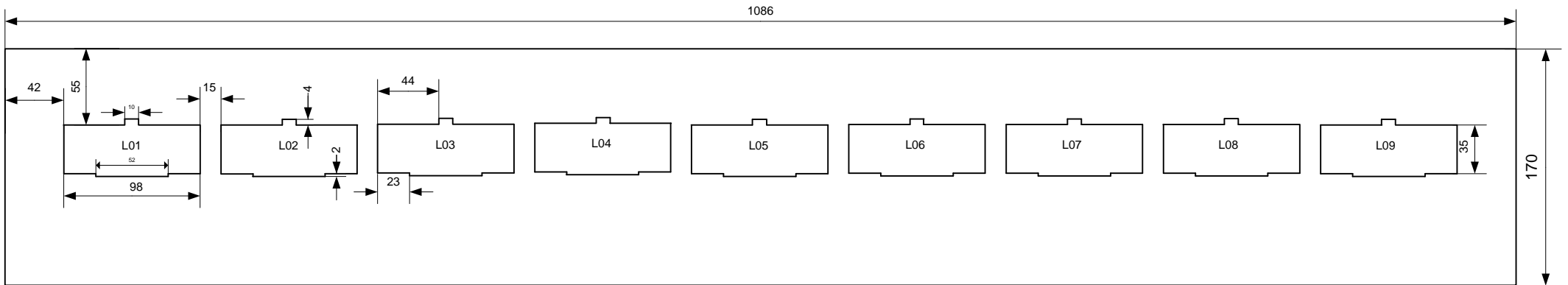

6HY29-2

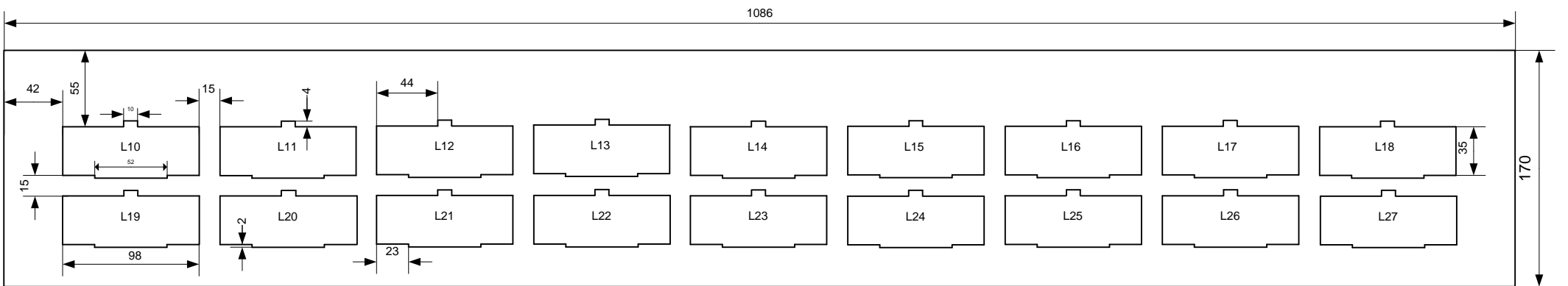

6HY30-1

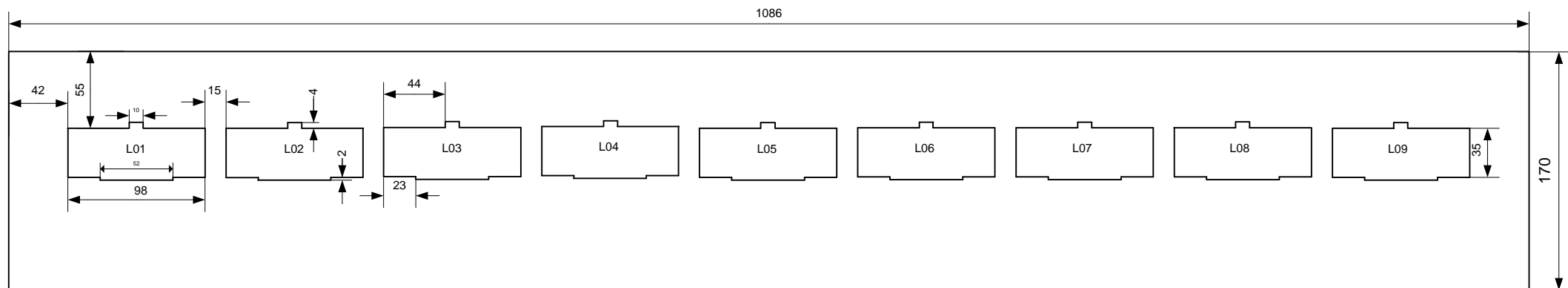

6HY30-2

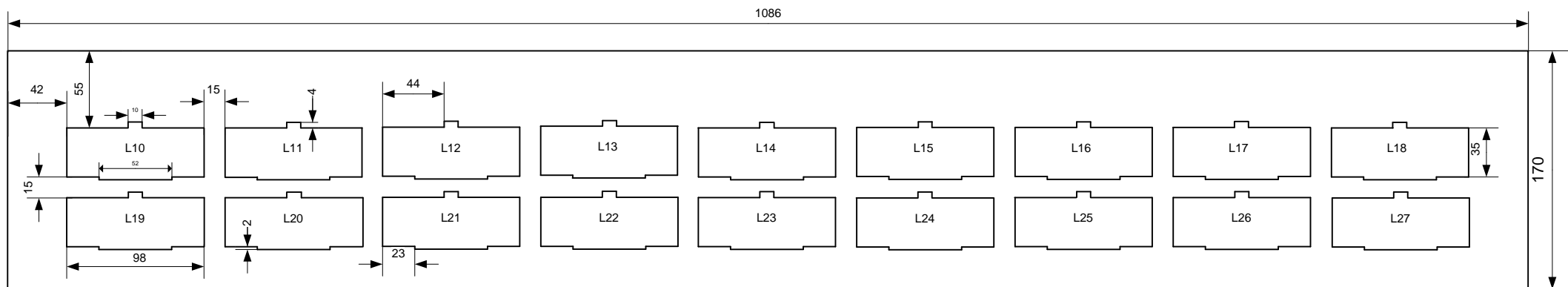

6HY31-1

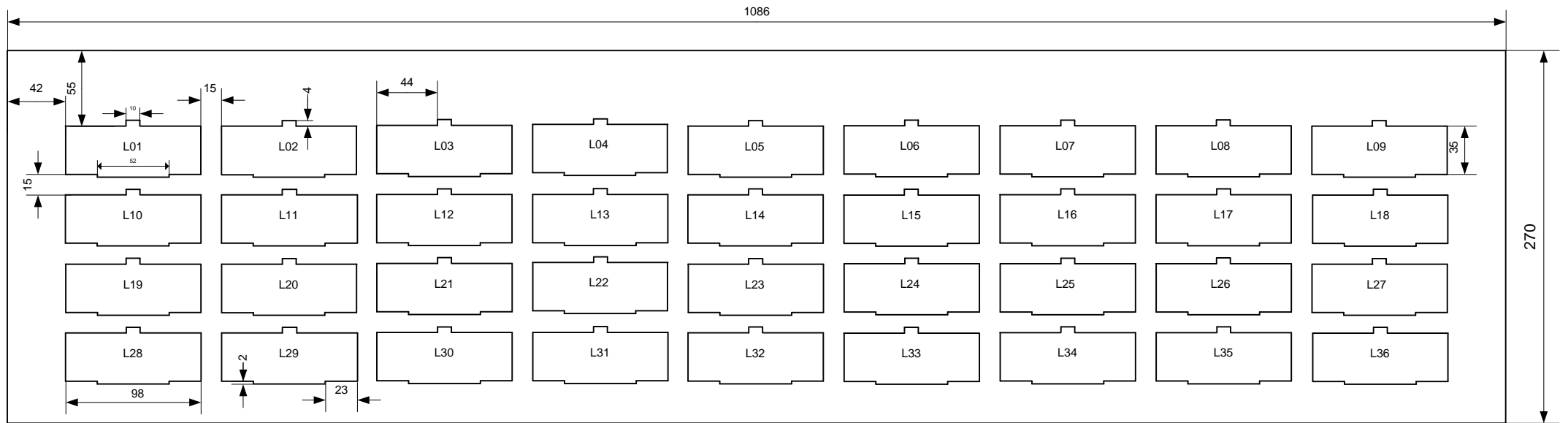

6HY31-2

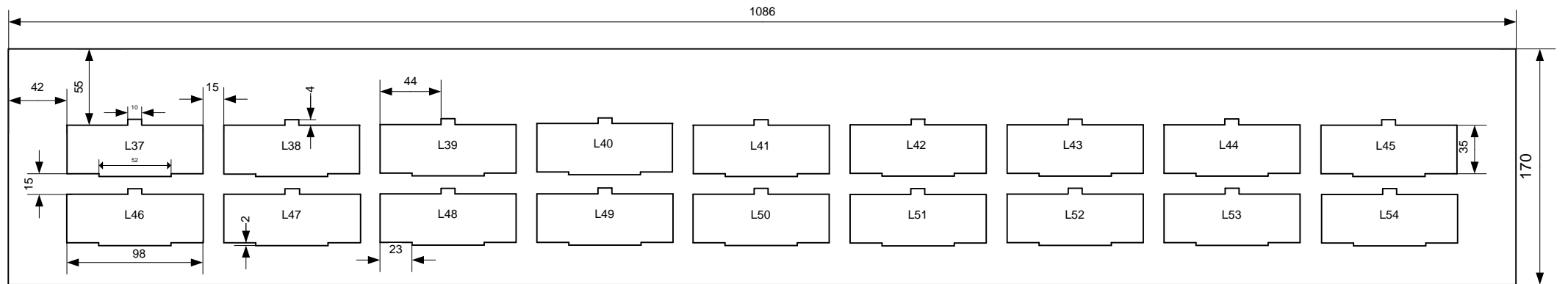

6HY32-1(6HY32-2)

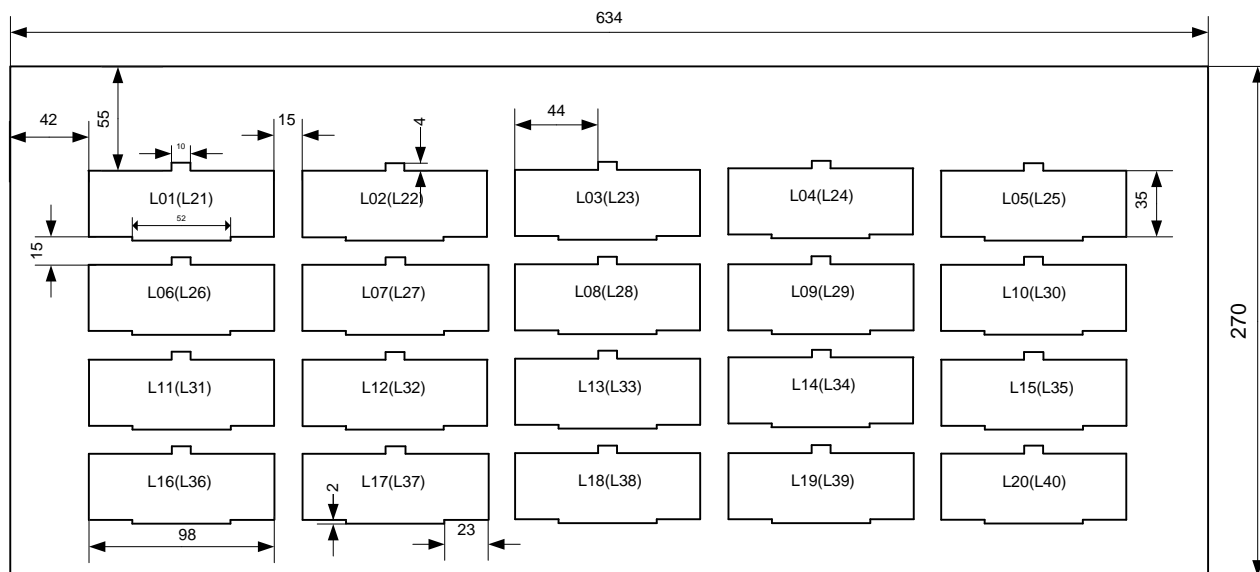

6HY32-3

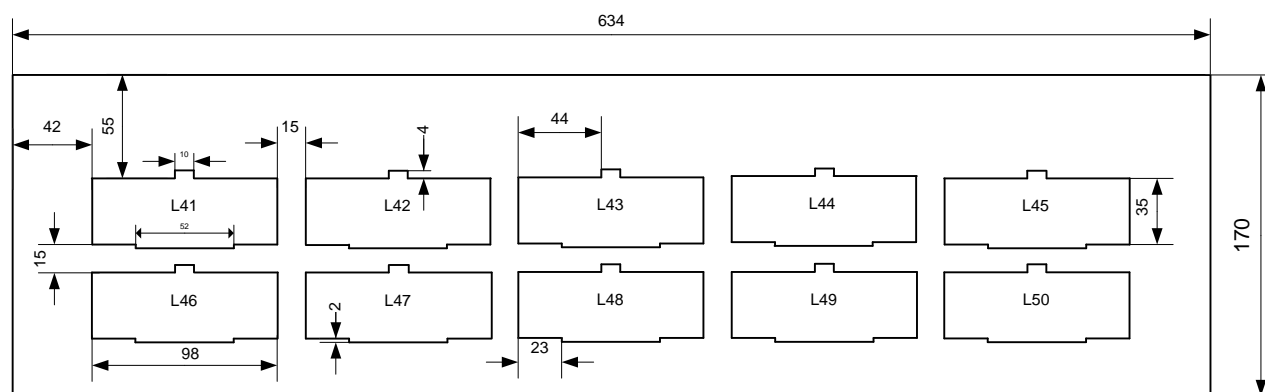

6HY33-1

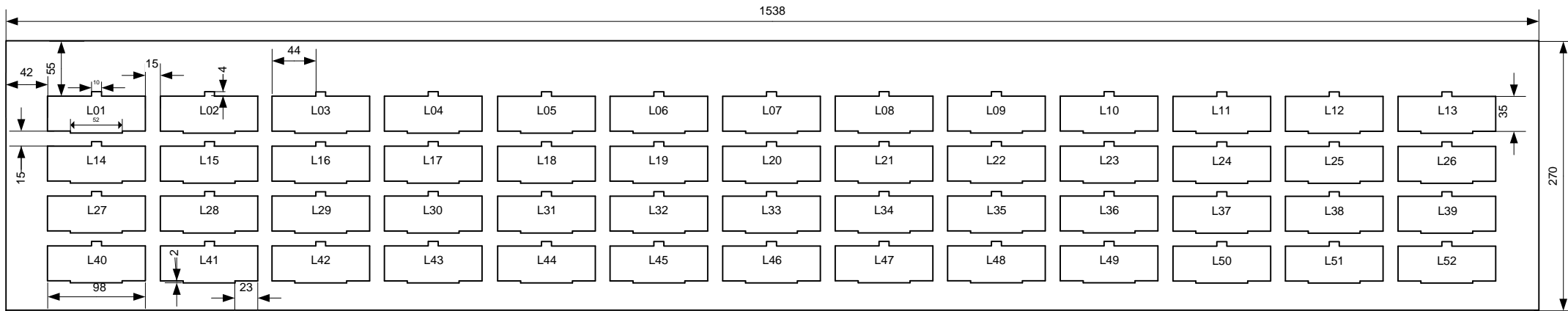

6HY33-2

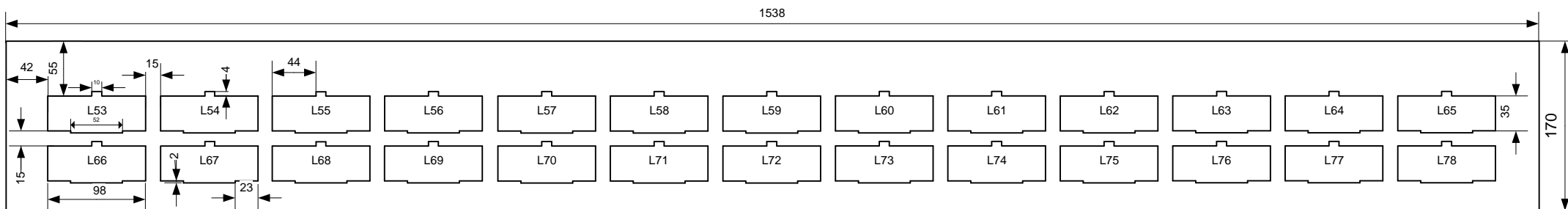

6HY34-1

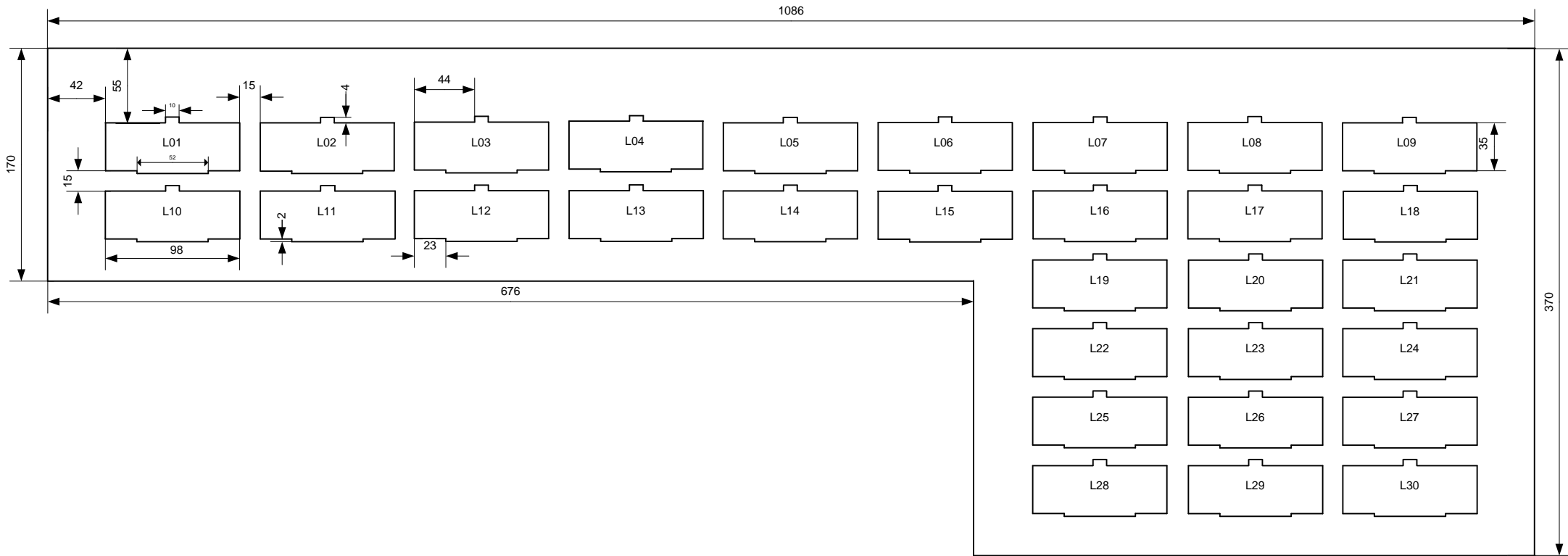

6HY35-1

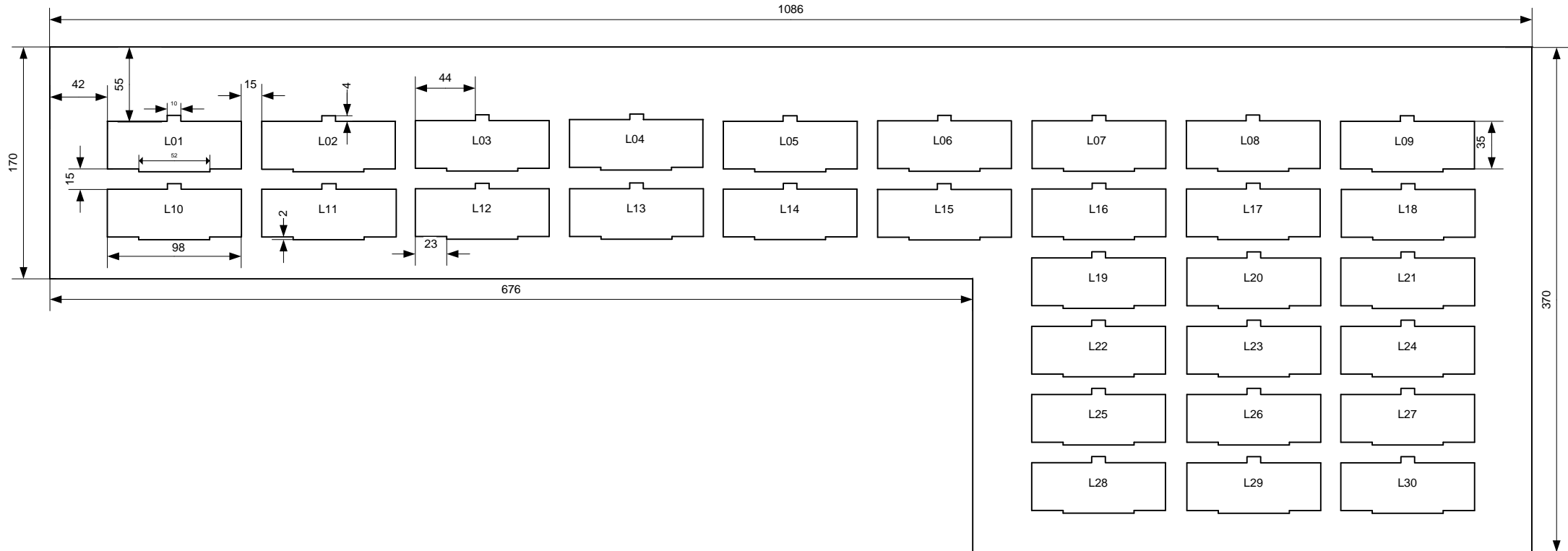

6HY36-1

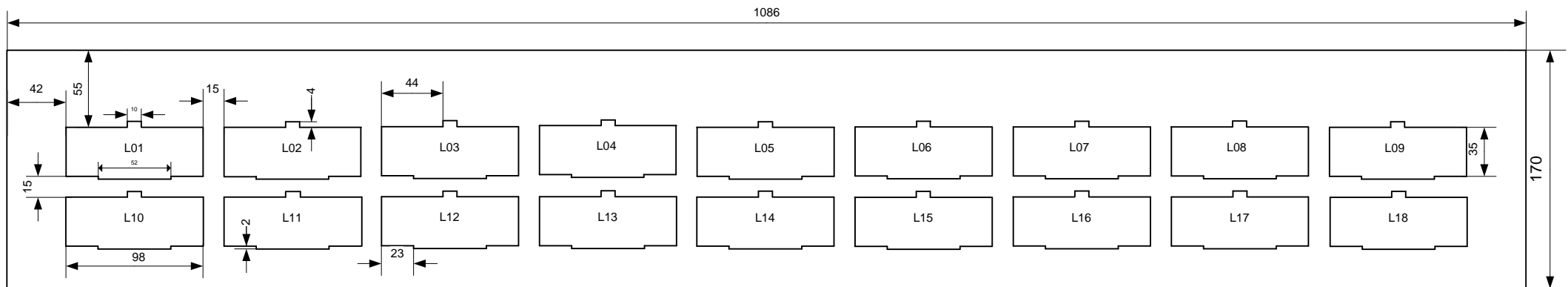

6HY14A-1

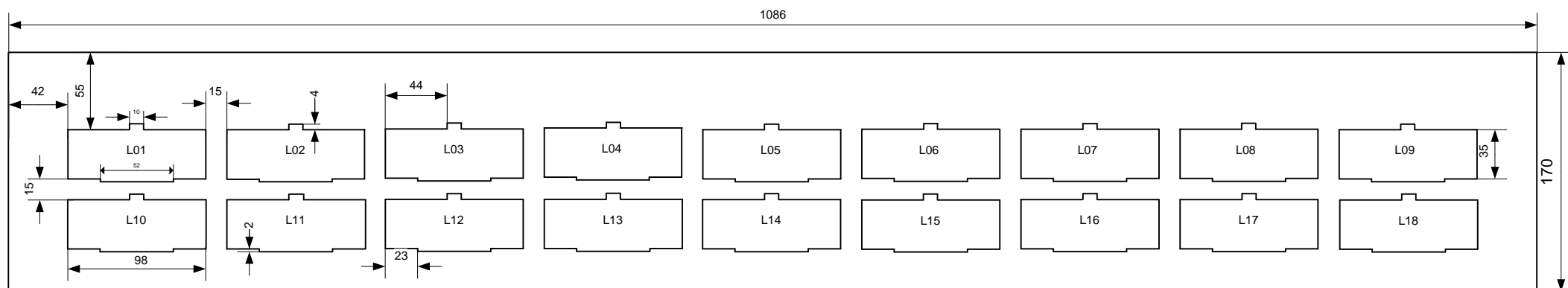

HY36																	
coord	coord	From	To	WC	CC	NC	IO	SC	Word	bit	remarks	power	origin	daisy	ped	rev_le	write_date
4	NULL	04HY036HLA001-01	04A681-K03-05	16	WH	1N						220VACN	04A550CB03		TSB	A	15.3.2004
	NULL	04HY036HLA001-01	04HY036HLA002-01	16	WH	1N						220VACN	04A550CB03		TSB		15.3.2004
4	NULL	04HY036HLA001-03	04A680-K11-NC	16	WH	1N						220VACN	04A550CB03		TSB	A	15.3.2004
	NULL	04HY036HLA001-03	04HY036HLA002-03	16	WH	1N						220VACN	04A550CB03		TSB		15.3.2004
	NULL	04HY036HLA001-04	04A800-TB POWER-02	16	BK	1N						220 VAC	04A550CB03		TSB		15.3.2004
	NULL	04HY036HLA001-CHASSIS	04W1B	16	WH							FRM GND			TSB		15.3.2004
	NULL	04HY036HLA002-01	04HY036HLA003-01	16	WH	1N						220VACN	04A550CB03		TSB		15.3.2004
	NULL	04HY036HLA002-03	04HY036HLA003-03	16	WH	1N						220VACN	04A550CB03		TSB		15.3.2004
	NULL	04HY036HLA002-04	04A800-TB POWER-04	16	BK	1N						220 VAC	04A550CB03		TSB		15.3.2004
	NULL	04HY036HLA002-CHASSIS	04W1B	16	WH							FRM GND			TSB		15.3.2004
	NULL	04HY036HLA003-01	04HY036HLA004-01	16	WH	1N						220VACN	04A550CB03		TSB		15.3.2004
	NULL	04HY036HLA003-03	04HY036HLA004-03	16	WH	1N						220VACN	04A550CB03		TSB		15.3.2004
	NULL	04HY036HLA003-04	04A800-TB POWER-06	16	BK	1N						220 VAC	04A550CB03		TSB		15.3.2004
	NULL	04HY036HLA003-CHASSIS	04W1B	16	WH							FRM GND			TSB		15.3.2004
	NULL	04HY036HLA004-01	04HY036HLA005-01	16	WH	1N						220VACN	04A550CB03		TSB		15.3.2004
	NULL	04HY036HLA004-03	04HY036HLA005-03	16	WH	1N						220VACN	04A550CB03		TSB		15.3.2004
	NULL	04HY036HLA004-04	04A800-TB POWER-08	16	BK	1N						220 VAC	04A550CB03		TSB		15.3.2004
	NULL	04HY036HLA004-CHASSIS	04W1B	16	WH							FRM GND			TSB		15.3.2004
	NULL	04HY036HLA005-01	04HY036HLA006-01	16	WH	1N						220VACN	04A550CB03		TSB		15.3.2004
	NULL	04HY036HLA005-03	04HY036HLA006-03	16	WH	1N						220VACN	04A550CB03		TSB		15.3.2004
	NULL	04HY036HLA005-04	04A800-TB POWER-10	16	BK	1N						220 VAC	04A550CB03		TSB		15.3.2004
	NULL	04HY036HLA005-CHASSIS	04W1B	16	WH							FRM GND			TSB		15.3.2004
	NULL	04HY036HLA006-01	04HY036HLA007-01	16	WH	1N						220VACN	04A550CB03		TSB		15.3.2004
	NULL	04HY036HLA006-03	04HY036HLA007-03	16	WH	1N						220VACN	04A550CB03		TSB		15.3.2004
	NULL	04HY036HLA006-04	04A800-TB POWER-12	16	BK	1N						220 VAC	04A550CB03		TSB		15.3.2004
	NULL	04HY036HLA006-CHASSIS	04W1B	16	WH							FRM GND			TSB		15.3.2004
	NULL	04HY036HLA007-01	04HY036HLA008-01	16	WH	1N						220VACN	04A550CB03		TSB		15.3.2004
	NULL	04HY036HLA007-03	04HY036HLA008-03	16	WH	1N						220VACN	04A550CB03		TSB		15.3.2004
	NULL	04HY036HLA007-04	04A800-TB POWER-14	16	BK	1N						220 VAC	04A550CB03		TSB		15.3.2004
	NULL	04HY036HLA007-CHASSIS	04W1B	16	WH							FRM GND			TSB		15.3.2004
	NULL	04HY036HLA008-01	04HY036HLA009-01	16	WH	1N						220VACN	04A550CB03		TSB		15.3.2004
	NULL	04HY036HLA008-03	04HY036HLA009-03	16	WH	1N						220VACN	04A550CB03		TSB		15.3.2004
	NULL	04HY036HLA008-04	04A800-TB POWER-16	16	BK	1N						220 VAC	04A550CB03		TSB		15.3.2004
	NULL	04HY036HLA008-CHASSIS	04W1B	16	WH							FRM GND			TSB		15.3.2004
	NULL	04HY036HLA009-01	04HY036HLA010-01	16	WH	1N						220VACN	04A550CB03		TSB		15.3.2004
	NULL	04HY036HLA009-03	04HY036HLA010-03	16	WH	1N						220VACN	04A550CB03		TSB		15.3.2004
	NULL	04HY036HLA009-04	04A800-TB POWER-18	16	BK	1N						220 VAC	04A550CB03		TSB		15.3.2004
	NULL	04HY036HLA009-CHASSIS	04W1B	16	WH							FRM GND			TSB		15.3.2004
	NULL	04HY036HLA010-01	04HY036HLA011-01	16	WH	1N						220VACN	04A550CB03		TSB		15.3.2004
	NULL	04HY036HLA010-03	04HY036HLA011-03	16	WH	1N						220VACN	04A550CB03		TSB		15.3.2004
	NULL	04HY036HLA010-04	04A800-TB POWER-20	16	BK	1N						220 VAC	04A550CB03		TSB		15.3.2004
	NULL	04HY036HLA010-CHASSIS	04W1B	16	WH							FRM GND			TSB		15.3.2004
	NULL	04HY036HLA011-01	04HY036HLA012-01	16	WH	1N						220VACN	04A550CB03		TSB		15.3.2004
	NULL	04HY036HLA011-03	04HY036HLA012-03	16	WH	1N						220VACN	04A550CB03		TSB		15.3.2004
	NULL	04HY036HLA011-04	04A800-TB POWER-22	16	BK	1N						220 VAC	04A550CB03		TSB		15.3.2004
	NULL	04HY036HLA011-CHASSIS	04W1B	16	WH							FRM GND			TSB		15.3.2004
	NULL	04HY036HLA012-01	04HY036HLA013-01	16	WH	1N						220VACN	04A550CB03		TSB		15.3.2004
	NULL	04HY036HLA012-03	04HY036HLA013-03	16	WH	1N						220VACN	04A550CB03		TSB		15.3.2004
	NULL	04HY036HLA012-04	04A800-TB POWER-24	16	BK	1N						220 VAC	04A550CB03		TSB		15.3.2004
	NULL	04HY036HLA012-CHASSIS	04W1B	16	WH							FRM GND			TSB		15.3.2004
	NULL	04HY036HLA013-01	04HY036HLA014-01	16	WH	1N						220VACN	04A550CB03		TSB		15.3.2004
	NULL	04HY036HLA013-03	04HY036HLA014-03	16	WH	1N						220VACN	04A550CB03		TSB		15.3.2004
	NULL	04HY036HLA013-04	04A800-TB POWER-26	16	BK	1N						220 VAC	04A550CB03		TSB		15.3.2004

coord	coord_	From	To	WC	CC	NC	IO	SC	Word	bit	remarks	power	origin	daisy_	ped	rev_le	write_date
	NULL	04HY034HLA005-01	04HY034HLA006-01	16	WH	1N						220VACN	04A550CB03		TSB		15.3.2004
	NULL	04HY034HLA005-03	04HY034HLA006-03	16	WH	1N						220VACN	04A550CB03		TSB		15.3.2004
	NULL	04HY034HLA005-04	04A801-TB POWER-14	16	BK	1N						220 VAC	04A550CB03		TSB		15.3.2004
	NULL	04HY034HLA005-CHASSIS	04W1C	16	WH							FRM GND			TSB		15.3.2004
	NULL	04HY034HLA006-01	04HY034HLA007-01	16	WH	1N						220VACN	04A550CB03		TSB		15.3.2004
	NULL	04HY034HLA006-03	04HY034HLA007-03	16	WH	1N						220VACN	04A550CB03		TSB		15.3.2004
	NULL	04HY034HLA006-04	04A801-TB POWER-16	16	BK	1N						220 VAC	04A550CB03		TSB		15.3.2004
	NULL	04HY034HLA006-CHASSIS	04W1C	16	WH							FRM GND			TSB		15.3.2004
	NULL	04HY034HLA007-01	04HY034HLA008-01	16	WH	1N						220VACN	04A550CB03		TSB		15.3.2004
	NULL	04HY034HLA007-03	04HY034HLA008-03	16	WH	1N						220VACN	04A550CB03		TSB		15.3.2004
	NULL	04HY034HLA007-04	04A801-TB POWER-18	16	BK	1N						220 VAC	04A550CB03		TSB		15.3.2004
	NULL	04HY034HLA007-CHASSIS	04W1C	16	WH							FRM GND			TSB		15.3.2004
	NULL	04HY034HLA008-01	04HY034HLA009-01	16	WH	1N						220VACN	04A550CB03		TSB		15.3.2004
	NULL	04HY034HLA008-03	04HY034HLA009-03	16	WH	1N						220VACN	04A550CB03		TSB		15.3.2004
	NULL	04HY034HLA008-04	04A801-TB POWER-20	16	BK	1N						220 VAC	04A550CB03		TSB		15.3.2004
	NULL	04HY034HLA008-CHASSIS	04W1C	16	WH							FRM GND			TSB		15.3.2004
	NULL	04HY034HLA009-01	04HY034HLA010-01	16	WH	1N						220VACN	04A550CB03		TSB		15.3.2004
	NULL	04HY034HLA009-03	04HY034HLA010-03	16	WH	1N						220VACN	04A550CB03		TSB		15.3.2004
	NULL	04HY034HLA009-04	04A801-TB POWER-22	16	BK	1N						220 VAC	04A550CB03		TSB		15.3.2004
	NULL	04HY034HLA009-CHASSIS	04W1C	16	WH							FRM GND			TSB		15.3.2004
	NULL	04HY034HLA010-01	04HY034HLA011-01	16	WH	1N						220VACN	04A550CB03		TSB		15.3.2004
	NULL	04HY034HLA010-03	04HY034HLA011-03	16	WH	1N						220VACN	04A550CB03		TSB		15.3.2004
	NULL	04HY034HLA010-04	04A801-TB POWER-24	16	BK	1N						220 VAC	04A550CB03		TSB		15.3.2004
	NULL	04HY034HLA010-CHASSIS	04W1C	16	WH							FRM GND			TSB		15.3.2004
	NULL	04HY034HLA011-01	04HY034HLA012-01	16	WH	1N						220VACN	04A550CB03		TSB		15.3.2004
	NULL	04HY034HLA011-03	04HY034HLA012-03	16	WH	1N						220VACN	04A550CB03		TSB		15.3.2004
	NULL	04HY034HLA011-04	04A801-TB POWER-26	16	BK	1N						220 VAC	04A550CB03		TSB		15.3.2004
	NULL	04HY034HLA011-CHASSIS	04W1C	16	WH							FRM GND			TSB		15.3.2004
	NULL	04HY034HLA012-01	04HY034HLA013-01	16	WH	1N						220VACN	04A550CB03		TSB		15.3.2004
	NULL	04HY034HLA012-03	04HY034HLA013-03	16	WH	1N						220VACN	04A550CB03		TSB		15.3.2004
	NULL	04HY034HLA012-04	04A801-TB POWER-28	16	BK	1N						220 VAC	04A550CB03		TSB		15.3.2004
	NULL	04HY034HLA012-CHASSIS	04W1C	16	WH							FRM GND			TSB		15.3.2004
	NULL	04HY034HLA013-01	04HY034HLA014-01	16	WH	1N						220VACN	04A550CB03		TSB		15.3.2004
	NULL	04HY034HLA013-03	04HY034HLA014-03	16	WH	1N						220VACN	04A550CB03		TSB		15.3.2004
	NULL	04HY034HLA013-04	04A801-TB POWER-30	16	BK	1N						220 VAC	04A550CB03		TSB		15.3.2004
	NULL	04HY034HLA013-CHASSIS	04W1C	16	WH							FRM GND			TSB		15.3.2004
	NULL	04HY034HLA014-01	04HY034HLA015-01	16	WH	1N						220VACN	04A550CB03		TSB		15.3.2004
	NULL	04HY034HLA014-03	04HY034HLA015-03	16	WH	1N						220VACN	04A550CB03		TSB		15.3.2004
	NULL	04HY034HLA014-04	04A801-TB POWER-32	16	BK	1N						220 VAC	04A550CB03		TSB		15.3.2004
	NULL	04HY034HLA014-CHASSIS	04W1C	16	WH							FRM GND			TSB		15.3.2004
	NULL	04HY034HLA015-01	04HY034HLA016-01	16	WH	1N						220VACN	04A550CB03		TSB		15.3.2004
	NULL	04HY034HLA015-03	04HY034HLA016-03	16	WH	1N						220VACN	04A550CB03		TSB		15.3.2004
	NULL	04HY034HLA015-04	04A802-TB POWER-02	16	BK	1N						220 VAC	04A550CB03		TSB		15.3.2004
	NULL	04HY034HLA015-CHASSIS	04W1C	16	WH							FRM GND			TSB		15.3.2004
	NULL	04HY034HLA016-01	04HY034HLA017-01	16	WH	1N						220VACN	04A550CB03		TSB		15.3.2004
	NULL	04HY034HLA016-03	04HY034HLA017-03	16	WH	1N						220VACN	04A550CB03		TSB		15.3.2004
	NULL	04HY034HLA016-04	04A802-TB POWER-04	16	BK	1N						220 VAC	04A550CB03		TSB		15.3.2004
	NULL	04HY034HLA016-CHASSIS	04W1C	16	WH							FRM GND			TSB		15.3.2004
	NULL	04HY034HLA017-01	04HY034HLA018-01	16	WH	1N						220VACN	04A550CB03		TSB		15.3.2004
	NULL	04HY034HLA017-03	04HY034HLA018-03	16	WH	1N						220VACN	04A550CB03		TSB		15.3.2004
	NULL	04HY034HLA017-04	04A802-TB POWER-06	16	BK	1N						220 VAC	04A550CB03		TSB		15.3.2004
	NULL	04HY034HLA017-CHASSIS	04W1C	16	WH							FRM GND			TSB		15.3.2004
	NULL	04HY034HLA018-01	04HY034HLA019-01	16	WH	1N						220VACN	04A550CB03		TSB		15.3.2004
	NULL	04HY034HLA018-03	04HY034HLA019-03	16	WH	1N						220VACN	04A550CB03		TSB		15.3.2004

coord	coord_	From	To	WC	CC	NC	IO	SC	Word	bit	remarks	power	origin	daisy_	ped	rev_le	write_date
	NULL	04HY034HLA018-04	04A802-TB POWER-08	16	BK	1N						220 VAC	04A550CB03		TSB		15.3.2004
	NULL	04HY034HLA018-CHASSIS	04W1C	16	WH							FRM GND			TSB		15.3.2004
	NULL	04HY034HLA019-01	04HY034HLA020-01	16	WH	1N						220VACN	04A550CB03		TSB		15.3.2004
	NULL	04HY034HLA019-03	04HY034HLA020-03	16	WH	1N						220VACN	04A550CB03		TSB		15.3.2004
	NULL	04HY034HLA019-04	04A802-TB POWER-10	16	BK	1N						220 VAC	04A550CB03		TSB		15.3.2004
	NULL	04HY034HLA019-CHASSIS	04W1C	16	WH							FRM GND			TSB		15.3.2004
	NULL	04HY034HLA020-01	04HY034HLA021-01	16	WH	1N						220VACN	04A550CB03		TSB		15.3.2004
	NULL	04HY034HLA020-03	04HY034HLA021-03	16	WH	1N						220VACN	04A550CB03		TSB		15.3.2004
	NULL	04HY034HLA020-04	04A802-TB POWER-12	16	BK	1N						220 VAC	04A550CB03		TSB		15.3.2004
	NULL	04HY034HLA020-CHASSIS	04W1C	16	WH							FRM GND			TSB		15.3.2004
	NULL	04HY034HLA021-01	04HY034HLA022-01	16	WH	1N						220VACN	04A550CB03		TSB		15.3.2004
	NULL	04HY034HLA021-03	04HY034HLA022-03	16	WH	1N						220VACN	04A550CB03		TSB		15.3.2004
	NULL	04HY034HLA021-04	04A802-TB POWER-14	16	BK	1N						220 VAC	04A550CB03		TSB		15.3.2004
	NULL	04HY034HLA021-CHASSIS	04W1C	16	WH							FRM GND			TSB		15.3.2004
	NULL	04HY034HLA022-01	04HY034HLA023-01	16	WH	1N						220VACN	04A550CB03		TSB		15.3.2004
	NULL	04HY034HLA022-03	04HY034HLA023-03	16	WH	1N						220VACN	04A550CB03		TSB		15.3.2004
	NULL	04HY034HLA022-04	04A802-TB POWER-16	16	BK	1N						220 VAC	04A550CB03		TSB		15.3.2004
	NULL	04HY034HLA022-CHASSIS	04W1C	16	WH							FRM GND			TSB		15.3.2004
	NULL	04HY034HLA023-01	04HY034HLA024-01	16	WH	1N						220VACN	04A550CB03		TSB		15.3.2004
	NULL	04HY034HLA023-03	04HY034HLA024-03	16	WH	1N						220VACN	04A550CB03		TSB		15.3.2004
	NULL	04HY034HLA023-04	04A802-TB POWER-18	16	BK	1N						220 VAC	04A550CB03		TSB		15.3.2004
	NULL	04HY034HLA023-CHASSIS	04W1C	16	WH							FRM GND			TSB		15.3.2004
	NULL	04HY034HLA024-01	04HY034HLA025-01	16	WH	1N						220VACN	04A550CB03		TSB		15.3.2004
	NULL	04HY034HLA024-03	04HY034HLA025-03	16	WH	1N						220VACN	04A550CB03		TSB		15.3.2004
	NULL	04HY034HLA024-04	04A802-TB POWER-20	16	BK	1N						220 VAC	04A550CB03		TSB		15.3.2004
	NULL	04HY034HLA024-CHASSIS	04W1C	16	WH							FRM GND			TSB		15.3.2004
	NULL	04HY034HLA025-01	04HY034HLA026-01	16	WH	1N						220VACN	04A550CB03		TSB		15.3.2004
	NULL	04HY034HLA025-03	04HY034HLA026-03	16	WH	1N						220VACN	04A550CB03		TSB		15.3.2004
	NULL	04HY034HLA025-04	04A802-TB POWER-22	16	BK	1N						220 VAC	04A550CB03		TSB		15.3.2004
	NULL	04HY034HLA025-CHASSIS	04W1C	16	WH							FRM GND			TSB		15.3.2004
	NULL	04HY034HLA026-01	04HY034HLA027-01	16	WH	1N						220VACN	04A550CB03		TSB		15.3.2004
	NULL	04HY034HLA026-03	04HY034HLA027-03	16	WH	1N						220VACN	04A550CB03		TSB		15.3.2004
	NULL	04HY034HLA026-04	04A802-TB POWER-24	16	BK	1N						220 VAC	04A550CB03		TSB		15.3.2004
	NULL	04HY034HLA026-CHASSIS	04W1C	16	WH							FRM GND			TSB		15.3.2004
	NULL	04HY034HLA027-01	04HY034HLA028-01	16	WH	1N						220VACN	04A550CB03		TSB		15.3.2004
	NULL	04HY034HLA027-03	04HY034HLA028-03	16	WH	1N						220VACN	04A550CB03		TSB		15.3.2004
	NULL	04HY034HLA027-04	04A802-TB POWER-26	16	BK	1N						220 VAC	04A550CB03		TSB		15.3.2004
	NULL	04HY034HLA027-CHASSIS	04W1C	16	WH							FRM GND			TSB		15.3.2004
	NULL	04HY034HLA028-01	04HY034HLA029-01	16	WH	1N						220VACN	04A550CB03		TSB		15.3.2004
	NULL	04HY034HLA028-03	04HY034HLA029-03	16	WH	1N						220VACN	04A550CB03		TSB		15.3.2004
	NULL	04HY034HLA028-04	04A802-TB POWER-28	16	BK	1N						220 VAC	04A550CB03		TSB		15.3.2004
	NULL	04HY034HLA028-CHASSIS	04W1C	16	WH							FRM GND			TSB		15.3.2004
	NULL	04HY034HLA029-01	04HY034HLA030-01	16	WH	1N						220VACN	04A550CB03		TSB		15.3.2004
	NULL	04HY034HLA029-03	04HY034HLA030-03	16	WH	1N						220VACN	04A550CB03		TSB		15.3.2004
	NULL	04HY034HLA029-04	04A802-TB POWER-30	16	BK	1N						220 VAC	04A550CB03		TSB		15.3.2004
	NULL	04HY034HLA029-CHASSIS	04W1D	16	WH							FRM GND			TSB		15.3.2004
	NULL	04HY034HLA030-01	04A681-K04-05	16	WH	1N						220VACN	04A550CB03		TSB	A	15.3.2004
	NULL	04HY034HLA030-03	04A680-K12-NC	16	WH	1N						220VACN	04A550CB03		TSB	A	15.3.2004
	NULL	04HY034HLA030-04	04A802-TB POWER-32	16	BK	1N						220 VAC	04A550CB03		TSB		15.3.2004
	NULL	04HY034HLA030-CHASSIS	04W1D	16	WH							FRM GND			TSB		15.3.2004
	NULL	04A801-TB SIGNAL-06	04A530-A2P04-03	22	WH		LO	4	001	02	04HY034HLA001				TSB		15.3.2004
	NULL	04A801-TB SIGNAL-08	04A530-A2P04-04	22	WH		LO	4	001	03	04HY034HLA002				TSB		15.3.2004
	NULL	04A801-TB SIGNAL-10	04A530-A2P04-05	22	WH		LO	4	001	04	04HY034HLA003				TSB		15.3.2004

coord	coord_	From	To	WC	CC	NC	IO	SC	Word	bit	remarks	power	origin	daisy_	ped	rev_le	write_date
	NULL	04A801-TB SIGNAL-12	04A530-A2P04-06	22	WH		LO	4	001	05	04HY034HLA004				TSB		15.3.2004
	NULL	04A801-TB SIGNAL-14	04A530-A2P04-07	22	WH		LO	4	001	06	04HY034HLA005				TSB		15.3.2004
	NULL	04A801-TB SIGNAL-16	04A530-A2P04-08	22	WH		LO	4	001	07	04HY034HLA006				TSB		15.3.2004
	NULL	04A801-TB SIGNAL-18	04A530-A2P04-09	22	WH		LO	4	001	08	04HY034HLA007				TSB		15.3.2004
	NULL	04A801-TB SIGNAL-20	04A530-A2P04-10	22	WH		LO	4	001	09	04HY034HLA008				TSB		15.3.2004
	NULL	04A801-TB SIGNAL-22	04A530-A2P04-11	22	WH		LO	4	001	10	04HY034HLA009				TSB		15.3.2004
	NULL	04A801-TB SIGNAL-24	04A530-A2P04-12	22	WH		LO	4	001	11	04HY034HLA010				TSB		15.3.2004
	NULL	04A801-TB SIGNAL-26	04A530-A2P04-13	22	WH		LO	4	001	12	04HY034HLA011				TSB		15.3.2004
	NULL	04A801-TB SIGNAL-28	04A530-A2P04-14	22	WH		LO	4	001	13	04HY034HLA012				TSB		15.3.2004
	NULL	04A801-TB SIGNAL-30	04A530-A2P04-15	22	WH		LO	4	001	14	04HY034HLA013				TSB		15.3.2004
	NULL	04A801-TB SIGNAL-32	04A530-A2P04-16	22	WH		LO	4	001	15	04HY034HLA014				TSB		15.3.2004
	NULL	04A802-TB SIGNAL-02	04A530-A2P05-01	22	WH		LO	4	002	00	04HY034HLA015				TSB		15.3.2004
	NULL	04A802-TB SIGNAL-04	04A530-A2P05-02	22	WH		LO	4	002	01	04HY034HLA016				TSB		15.3.2004
	NULL	04A802-TB SIGNAL-06	04A530-A2P05-03	22	WH		LO	4	002	02	04HY034HLA017				TSB		15.3.2004
	NULL	04A802-TB SIGNAL-08	04A530-A2P05-04	22	WH		LO	4	002	03	04HY034HLA018				TSB		15.3.2004
	NULL	04A802-TB SIGNAL-10	04A530-A2P05-05	22	WH		LO	4	002	04	04HY034HLA019				TSB		15.3.2004
	NULL	04A802-TB SIGNAL-12	04A530-A2P05-06	22	WH		LO	4	002	05	04HY034HLA020				TSB		15.3.2004
	NULL	04A802-TB SIGNAL-14	04A530-A2P05-07	22	WH		LO	4	002	06	04HY034HLA021				TSB		15.3.2004
	NULL	04A802-TB SIGNAL-16	04A530-A2P05-08	22	WH		LO	4	002	07	04HY034HLA022				TSB		15.3.2004
	NULL	04A802-TB SIGNAL-18	04A530-A2P05-09	22	WH		LO	4	002	08	04HY034HLA023				TSB		15.3.2004
	NULL	04A802-TB SIGNAL-20	04A530-A2P05-10	22	WH		LO	4	002	09	04HY034HLA024				TSB		15.3.2004
	NULL	04A802-TB SIGNAL-22	04A530-A2P05-11	22	WH		LO	4	002	10	04HY034HLA025				TSB		15.3.2004
	NULL	04A802-TB SIGNAL-24	04A530-A2P05-12	22	WH		LO	4	002	11	04HY034HLA026				TSB		15.3.2004
	NULL	04A802-TB SIGNAL-26	04A530-A2P05-13	22	WH		LO	4	002	12	04HY034HLA027				TSB		15.3.2004
	NULL	04A802-TB SIGNAL-28	04A530-A2P05-14	22	WH		LO	4	002	13	04HY034HLA028				TSB		15.3.2004
	NULL	04A802-TB SIGNAL-30	04A530-A2P05-15	22	WH		LO	4	002	14	04HY034HLA029				TSB		15.3.2004
	NULL	04A802-TB SIGNAL-32	04A530-A2P05-16	22	WH		LO	4	002	15	04HY034HLA030				TSB		15.3.2004
HY35																	
4	NULL	04HY035HLA001-01	04A683-K01-05	16	WH	1N						220VACN	04A550CB03		TSB	A	15.3.2004
	NULL	04HY035HLA001-01	04HY035HLA002-01	16	WH	1N						220VACN	04A550CB03		TSB		15.3.2004
4	NULL	04HY035HLA001-03	04A680-K13-NC	16	WH	1N						220VACN	04A550CB03		TSB	A	15.3.2004
	NULL	04HY035HLA001-03	04HY035HLA002-03	16	WH	1N						220VACN	04A550CB03		TSB		15.3.2004
	NULL	04HY035HLA001-04	04A803-TB POWER-02	16	BK	1N						220 VAC	04A550CB03		TSB		15.3.2004
	NULL	04HY035HLA001-CHASSIS	04W1D	16	WH							FRM GND			TSB		15.3.2004
	NULL	04HY035HLA002-01	04HY035HLA003-01	16	WH	1N						220VACN	04A550CB03		TSB		15.3.2004
	NULL	04HY035HLA002-03	04HY035HLA003-03	16	WH	1N						220VACN	04A550CB03		TSB		15.3.2004
	NULL	04HY035HLA002-04	04A803-TB POWER-04	16	BK	1N						220 VAC	04A550CB03		TSB		15.3.2004
	NULL	04HY035HLA002-CHASSIS	04W1D	16	WH							FRM GND			TSB		15.3.2004
	NULL	04HY035HLA003-01	04HY035HLA004-01	16	WH	1N						220VACN	04A550CB03		TSB		15.3.2004
	NULL	04HY035HLA003-03	04HY035HLA004-03	16	WH	1N						220VACN	04A550CB03		TSB		15.3.2004
	NULL	04HY035HLA003-04	04A803-TB POWER-06	16	BK	1N						220 VAC	04A550CB03		TSB		15.3.2004
	NULL	04HY035HLA003-CHASSIS	04W1D	16	WH							FRM GND			TSB		15.3.2004
	NULL	04HY035HLA004-01	04HY035HLA005-01	16	WH	1N						220VACN	04A550CB03		TSB		15.3.2004
	NULL	04HY035HLA004-03	04HY035HLA005-03	16	WH	1N						220VACN	04A550CB03		TSB		15.3.2004
	NULL	04HY035HLA004-04	04A803-TB POWER-08	16	BK	1N						220 VAC	04A550CB03		TSB		15.3.2004
	NULL	04HY035HLA004-CHASSIS	04W1D	16	WH							FRM GND			TSB		15.3.2004
	NULL	04HY035HLA005-01	04HY035HLA006-01	16	WH	1N						220VACN	04A550CB03		TSB		15.3.2004
	NULL	04HY035HLA005-03	04HY035HLA006-03	16	WH	1N						220VACN	04A550CB03		TSB		15.3.2004
	NULL	04HY035HLA005-04	04A803-TB POWER-10	16	BK	1N						220 VAC	04A550CB03		TSB		15.3.2004
	NULL	04HY035HLA005-CHASSIS	04W1D	16	WH							FRM GND			TSB		15.3.2004
	NULL	04HY035HLA006-01	04HY035HLA007-01	16	WH	1N						220VACN	04A550CB03		TSB		15.3.2004
	NULL	04HY035HLA006-03	04HY035HLA007-03	16	WH	1N						220VACN	04A550CB03		TSB		15.3.2004
	NULL	04HY035HLA006-04	04A803-TB POWER-12	16	BK	1N						220 VAC	04A550CB03		TSB		15.3.2004
	NULL	04HY035HLA006-CHASSIS	04W1D	16	WH							FRM GND			TSB		15.3.2004

coord	coord_	From	To	WC	CC	NC	IO	SC	Word	bit	remarks	power	origin	daisy_	ped	rev_le	write_date
	NULL	04HY035HLA007-01	04HY035HLA008-01	16	WH	1N						220VACN	04A550CB03		TSB		15.3.2004
	NULL	04HY035HLA007-03	04HY035HLA008-03	16	WH	1N						220VACN	04A550CB03		TSB		15.3.2004
	NULL	04HY035HLA007-04	04A803-TB POWER-14	16	BK	1N						220 VAC	04A550CB03		TSB		15.3.2004
	NULL	04HY035HLA007-CHASSIS	04W1D	16	WH							FRM GND			TSB		15.3.2004
	NULL	04HY035HLA008-01	04HY035HLA009-01	16	WH	1N						220VACN	04A550CB03		TSB		15.3.2004
	NULL	04HY035HLA008-03	04HY035HLA009-03	16	WH	1N						220VACN	04A550CB03		TSB		15.3.2004
	NULL	04HY035HLA008-04	04A803-TB POWER-16	16	BK	1N						220 VAC	04A550CB03		TSB		15.3.2004
	NULL	04HY035HLA008-CHASSIS	04W1D	16	WH							FRM GND			TSB		15.3.2004
	NULL	04HY035HLA009-01	04HY035HLA010-01	16	WH	1N						220VACN	04A550CB03		TSB		15.3.2004
	NULL	04HY035HLA009-03	04HY035HLA010-03	16	WH	1N						220VACN	04A550CB03		TSB		15.3.2004
	NULL	04HY035HLA009-04	04A803-TB POWER-18	16	BK	1N						220 VAC	04A550CB03		TSB		15.3.2004
	NULL	04HY035HLA009-CHASSIS	04W1D	16	WH							FRM GND			TSB		15.3.2004
	NULL	04HY035HLA010-01	04HY035HLA011-01	16	WH	1N						220VACN	04A550CB03		TSB		15.3.2004
	NULL	04HY035HLA010-03	04HY035HLA011-03	16	WH	1N						220VACN	04A550CB03		TSB		15.3.2004
	NULL	04HY035HLA010-04	04A803-TB POWER-20	16	BK	1N						220 VAC	04A550CB03		TSB		15.3.2004
	NULL	04HY035HLA010-CHASSIS	04W1D	16	WH							FRM GND			TSB		15.3.2004
	NULL	04HY035HLA011-01	04HY035HLA012-01	16	WH	1N						220VACN	04A550CB03		TSB		15.3.2004
	NULL	04HY035HLA011-03	04HY035HLA012-03	16	WH	1N						220VACN	04A550CB03		TSB		15.3.2004
	NULL	04HY035HLA011-04	04A803-TB POWER-22	16	BK	1N						220 VAC	04A550CB03		TSB		15.3.2004
	NULL	04HY035HLA011-CHASSIS	04W1D	16	WH							FRM GND			TSB		15.3.2004
	NULL	04HY035HLA012-01	04HY035HLA013-01	16	WH	1N						220VACN	04A550CB03		TSB		15.3.2004
	NULL	04HY035HLA012-03	04HY035HLA013-03	16	WH	1N						220VACN	04A550CB03		TSB		15.3.2004
	NULL	04HY035HLA012-04	04A803-TB POWER-24	16	BK	1N						220 VAC	04A550CB03		TSB		15.3.2004
	NULL	04HY035HLA012-CHASSIS	04W1D	16	WH							FRM GND			TSB		15.3.2004
	NULL	04HY035HLA013-01	04HY035HLA014-01	16	WH	1N						220VACN	04A550CB03		TSB		15.3.2004
	NULL	04HY035HLA013-03	04HY035HLA014-03	16	WH	1N						220VACN	04A550CB03		TSB		15.3.2004
	NULL	04HY035HLA013-04	04A803-TB POWER-26	16	BK	1N						220 VAC	04A550CB03		TSB		15.3.2004
	NULL	04HY035HLA013-CHASSIS	04W1D	16	WH							FRM GND			TSB		15.3.2004
	NULL	04HY035HLA014-01	04HY035HLA015-01	16	WH	1N						220VACN	04A550CB03		TSB		15.3.2004
	NULL	04HY035HLA014-03	04HY035HLA015-03	16	WH	1N						220VACN	04A550CB03		TSB		15.3.2004
	NULL	04HY035HLA014-04	04A803-TB POWER-28	16	BK	1N						220 VAC	04A550CB03		TSB		15.3.2004
	NULL	04HY035HLA014-CHASSIS	04W1D	16	WH							FRM GND			TSB		15.3.2004
	NULL	04HY035HLA015-01	04HY035HLA016-01	16	WH	1N						220VACN	04A550CB03		TSB		15.3.2004
	NULL	04HY035HLA015-03	04HY035HLA016-03	16	WH	1N						220VACN	04A550CB03		TSB		15.3.2004
	NULL	04HY035HLA015-04	04A803-TB POWER-30	16	BK	1N						220 VAC	04A550CB03		TSB		15.3.2004
	NULL	04HY035HLA015-CHASSIS	04W1D	16	WH							FRM GND			TSB		15.3.2004
	NULL	04HY035HLA016-01	04HY035HLA017-01	16	WH	1N						220VACN	04A550CB03		TSB		15.3.2004
	NULL	04HY035HLA016-03	04HY035HLA017-03	16	WH	1N						220VACN	04A550CB03		TSB		15.3.2004
	NULL	04HY035HLA016-04	04A803-TB POWER-32	16	BK	1N						220 VAC	04A550CB03		TSB		15.3.2004
	NULL	04HY035HLA016-CHASSIS	04W1D	16	WH							FRM GND			TSB		15.3.2004
	NULL	04HY035HLA017-01	04HY035HLA018-01	16	WH	1N						220VACN	04A550CB03		TSB		15.3.2004
	NULL	04HY035HLA017-03	04HY035HLA018-03	16	WH	1N						220VACN	04A550CB03		TSB		15.3.2004
	NULL	04HY035HLA017-04	04A804-TB POWER-02	16	BK	1N						220 VAC	04A550CB03		TSB		15.3.2004
	NULL	04HY035HLA017-CHASSIS	04W1D	16	WH							FRM GND			TSB		15.3.2004
	NULL	04HY035HLA018-01	04HY035HLA019-01	16	WH	1N						220VACN	04A550CB03		TSB		15.3.2004
	NULL	04HY035HLA018-03	04HY035HLA019-03	16	WH	1N						220VACN	04A550CB03		TSB		15.3.2004
	NULL	04HY035HLA018-04	04A804-TB POWER-04	16	BK	1N						220 VAC	04A550CB03		TSB		15.3.2004
	NULL	04HY035HLA018-CHASSIS	04W1D	16	WH							FRM GND			TSB		15.3.2004
	NULL	04HY035HLA019-01	04HY035HLA020-01	16	WH	1N						220VACN	04A550CB03		TSB		15.3.2004
	NULL	04HY035HLA019-03	04HY035HLA020-03	16	WH	1N						220VACN	04A550CB03		TSB		15.3.2004
	NULL	04HY035HLA019-04	04A804-TB POWER-06	16	BK	1N						220 VAC	04A550CB03		TSB		15.3.2004
	NULL	04HY035HLA019-CHASSIS	04W1D	16	WH							FRM GND			TSB		15.3.2004
	NULL	04HY035HLA020-01	04HY035HLA021-01	16	WH	1N						220VACN	04A550CB03		TSB		15.3.2004
	NULL	04HY035HLA020-03	04HY035HLA021-03	16	WH	1N						220VACN	04A550CB03		TSB		15.3.2004

coord	coord_	From	To	WC	CC	NC	IO	SC	Word	bit	remarks	power	origin	daisy_	ped	rev_le	write_date
	NULL	04HY035HLA020-04	04A804-TB POWER-08	16	BK	1N						220 VAC	04A550CB03		TSB		15.3.2004
	NULL	04HY035HLA020-CHASSIS	04W1D	16	WH							FRM GND			TSB		15.3.2004
	NULL	04HY035HLA021-01	04HY035HLA022-01	16	WH	1N						220VACN	04A550CB03		TSB		15.3.2004
	NULL	04HY035HLA021-03	04HY035HLA022-03	16	WH	1N						220VACN	04A550CB03		TSB		15.3.2004
	NULL	04HY035HLA021-04	04A804-TB POWER-10	16	BK	1N						220 VAC	04A550CB03		TSB		15.3.2004
	NULL	04HY035HLA021-CHASSIS	04W1D	16	WH							FRM GND			TSB		15.3.2004
	NULL	04HY035HLA022-01	04HY035HLA023-01	16	WH	1N						220VACN	04A550CB03		TSB		15.3.2004
	NULL	04HY035HLA022-03	04HY035HLA023-03	16	WH	1N						220VACN	04A550CB03		TSB		15.3.2004
	NULL	04HY035HLA022-04	04A804-TB POWER-12	16	BK	1N						220 VAC	04A550CB03		TSB		15.3.2004
	NULL	04HY035HLA022-CHASSIS	04W1D	16	WH							FRM GND			TSB		15.3.2004
	NULL	04HY035HLA023-01	04HY035HLA024-01	16	WH	1N						220VACN	04A550CB03		TSB		15.3.2004
	NULL	04HY035HLA023-03	04HY035HLA024-03	16	WH	1N						220VACN	04A550CB03		TSB		15.3.2004
	NULL	04HY035HLA023-04	04A804-TB POWER-14	16	BK	1N						220 VAC	04A550CB03		TSB		15.3.2004
	NULL	04HY035HLA023-CHASSIS	04W1D	16	WH							FRM GND			TSB		15.3.2004
	NULL	04HY035HLA024-01	04HY035HLA025-01	16	WH	1N						220VACN	04A550CB03		TSB		15.3.2004
	NULL	04HY035HLA024-03	04HY035HLA025-03	16	WH	1N						220VACN	04A550CB03		TSB		15.3.2004
	NULL	04HY035HLA024-04	04A804-TB POWER-16	16	BK	1N						220 VAC	04A550CB03		TSB		15.3.2004
	NULL	04HY035HLA024-CHASSIS	04W1D	16	WH							FRM GND			TSB		15.3.2004
	NULL	04HY035HLA025-01	04HY035HLA026-01	16	WH	1N						220VACN	04A550CB03		TSB		15.3.2004
	NULL	04HY035HLA025-03	04HY035HLA026-03	16	WH	1N						220VACN	04A550CB03		TSB		15.3.2004
	NULL	04HY035HLA025-04	04A804-TB POWER-18	16	BK	1N						220 VAC	04A550CB03		TSB		15.3.2004
	NULL	04HY035HLA025-CHASSIS	04W1D	16	WH							FRM GND			TSB		15.3.2004
	NULL	04HY035HLA026-01	04HY035HLA027-01	16	WH	1N						220VACN	04A550CB03		TSB		15.3.2004
	NULL	04HY035HLA026-03	04HY035HLA027-03	16	WH	1N						220VACN	04A550CB03		TSB		15.3.2004
	NULL	04HY035HLA026-04	04A804-TB POWER-20	16	BK	1N						220 VAC	04A550CB03		TSB		15.3.2004
	NULL	04HY035HLA026-CHASSIS	04W1D	16	WH							FRM GND			TSB		15.3.2004
	NULL	04HY035HLA027-01	04HY035HLA028-01	16	WH	1N						220VACN	04A550CB03		TSB		15.3.2004
	NULL	04HY035HLA027-03	04HY035HLA028-03	16	WH	1N						220VACN	04A550CB03		TSB		15.3.2004
	NULL	04HY035HLA027-04	04A804-TB POWER-22	16	BK	1N						220 VAC	04A550CB03		TSB		15.3.2004
	NULL	04HY035HLA027-CHASSIS	04W1E	16	WH							FRM GND			TSB		15.3.2004
	NULL	04HY035HLA028-01	04HY035HLA029-01	16	WH	1N						220VACN	04A550CB03		TSB		15.3.2004
	NULL	04HY035HLA028-03	04HY035HLA029-03	16	WH	1N						220VACN	04A550CB03		TSB		15.3.2004
	NULL	04HY035HLA028-04	04A804-TB POWER-24	16	BK	1N						220 VAC	04A550CB03		TSB		15.3.2004
	NULL	04HY035HLA028-CHASSIS	04W1E	16	WH							FRM GND			TSB		15.3.2004
	NULL	04HY035HLA029-01	04HY035HLA030-01	16	WH	1N						220VACN	04A550CB03		TSB		15.3.2004
	NULL	04HY035HLA029-03	04HY035HLA030-03	16	WH	1N						220VACN	04A550CB03		TSB		15.3.2004
	NULL	04HY035HLA029-04	04A804-TB POWER-26	16	BK	1N						220 VAC	04A550CB03		TSB		15.3.2004
	NULL	04HY035HLA029-CHASSIS	04W1E	16	WH							FRM GND			TSB		15.3.2004
	NULL	04HY035HLA030-04	04A804-TB POWER-28	16	BK	1N						220 VAC	04A550CB03		TSB		15.3.2004
	NULL	04HY035HLA030-CHASSIS	04W1E	16	WH							FRM GND			TSB		15.3.2004
	NULL	04A803-TB SIGNAL-02	04A530-A2P06-01	22	WH		LO	4	003	00	04HY035HLA001				TSB		15.3.2004
	NULL	04A803-TB SIGNAL-04	04A530-A2P06-02	22	WH		LO	4	003	01	04HY035HLA002				TSB		15.3.2004
	NULL	04A803-TB SIGNAL-06	04A530-A2P06-03	22	WH		LO	4	003	02	04HY035HLA003				TSB		15.3.2004
	NULL	04A803-TB SIGNAL-08	04A530-A2P06-04	22	WH		LO	4	003	03	04HY035HLA004				TSB		15.3.2004
	NULL	04A803-TB SIGNAL-10	04A530-A2P06-05	22	WH		LO	4	003	04	04HY035HLA005				TSB		15.3.2004
	NULL	04A803-TB SIGNAL-12	04A530-A2P06-06	22	WH		LO	4	003	05	04HY035HLA006				TSB		15.3.2004
	NULL	04A803-TB SIGNAL-14	04A530-A2P06-07	22	WH		LO	4	003	06	04HY035HLA007				TSB		15.3.2004
	NULL	04A803-TB SIGNAL-16	04A530-A2P06-08	22	WH		LO	4	003	07	04HY035HLA008				TSB		15.3.2004
	NULL	04A803-TB SIGNAL-18	04A530-A2P06-09	22	WH		LO	4	003	08	04HY035HLA009				TSB		15.3.2004
	NULL	04A803-TB SIGNAL-20	04A530-A2P06-10	22	WH		LO	4	003	09	04HY035HLA010				TSB		15.3.2004
	NULL	04A803-TB SIGNAL-22	04A530-A2P06-11	22	WH		LO	4	003	10	04HY035HLA011				TSB		15.3.2004
	NULL	04A803-TB SIGNAL-24	04A530-A2P06-12	22	WH		LO	4	003	11	04HY035HLA012				TSB		15.3.2004
	NULL	04A803-TB SIGNAL-26	04A530-A2P06-13	22	WH		LO	4	003	12	04HY035HLA013				TSB		15.3.2004

coord	coord_	From	To	WC	CC	NC	IO	SC	Word	bit	remarks	power	origin	daisy_	ped	rev_le	write_date
	NULL	04A803-TB SIGNAL-28	04A530-A2P06-14	22	WH		LO	4	003	13	04HY035HLA014				TSB		15.3.2004
	NULL	04A803-TB SIGNAL-30	04A530-A2P06-15	22	WH		LO	4	003	14	04HY035HLA015				TSB		15.3.2004
	NULL	04A803-TB SIGNAL-32	04A530-A2P06-16	22	WH		LO	4	003	15	04HY035HLA016				TSB		15.3.2004
	NULL	04A804-TB SIGNAL-02	04A530-A2P07-01	22	WH		LO	4	004	00	04HY035HLA017				TSB		15.3.2004
	NULL	04A804-TB SIGNAL-04	04A530-A2P07-02	22	WH		LO	4	004	01	04HY035HLA018				TSB		15.3.2004
	NULL	04A804-TB SIGNAL-06	04A530-A2P07-03	22	WH		LO	4	004	02	04HY035HLA019				TSB		15.3.2004
	NULL	04A804-TB SIGNAL-08	04A530-A2P07-04	22	WH		LO	4	004	03	04HY035HLA020				TSB		15.3.2004
	NULL	04A804-TB SIGNAL-10	04A530-A2P07-05	22	WH		LO	4	004	04	04HY035HLA021				TSB		15.3.2004
	NULL	04A804-TB SIGNAL-12	04A530-A2P07-06	22	WH		LO	4	004	05	04HY035HLA022				TSB		15.3.2004
	NULL	04A804-TB SIGNAL-14	04A530-A2P07-07	22	WH		LO	4	004	06	04HY035HLA023				TSB		15.3.2004
	NULL	04A804-TB SIGNAL-16	04A530-A2P07-08	22	WH		LO	4	004	07	04HY035HLA024				TSB		15.3.2004
	NULL	04A804-TB SIGNAL-18	04A530-A2P07-09	22	WH		LO	4	004	08	04HY035HLA025				TSB		15.3.2004
	NULL	04A804-TB SIGNAL-20	04A530-A2P07-10	22	WH		LO	4	004	09	04HY035HLA026				TSB		15.3.2004
	NULL	04A804-TB SIGNAL-22	04A530-A2P07-11	22	WH		LO	4	004	10	04HY035HLA027				TSB		15.3.2004
	NULL	04A804-TB SIGNAL-24	04A530-A2P07-12	22	WH		LO	4	004	11	04HY035HLA028				TSB		15.3.2004
	NULL	04A804-TB SIGNAL-26	04A530-A2P07-13	22	WH		LO	4	004	12	04HY035HLA029				TSB		15.3.2004
	NULL	04A804-TB SIGNAL-28	04A530-A2P07-14	22	WH		LO	4	004	13	04HY035HLA030				TSB		15.3.2004
HY14A																	
	NULL	04HY14AHLA001-01	04HY14AHLA002-01	16	WH	1N						220VACN	04A550CB03		TSB		15.3.2004
	NULL	04HY14AHLA001-03	04HY14AHLA002-03	16	WH	1N						220VACN	04A550CB03		TSB		15.3.2004
	NULL	04HY14AHLA001-04	04A804-TB POWER-30	16	BK	1N						220 VAC	04A550CB03		TSB		15.3.2004
	NULL	04HY14AHLA001-CHASSIS	04W1E	16	WH							FRM GND			TSB		15.3.2004
	NULL	04HY14AHLA002-01	04A681-K02-05	16	WH	1N						220VACN	04A550CB03		TSB	A	15.3.2004
	NULL	04HY14AHLA002-03	04A681-K01-05	16	WH	1N						220VACN	04A550CB03		TSB	A	15.3.2004
	NULL	04HY14AHLA002-04	04A804-TB POWER-32	16	BK	1N						220 VAC	04A550CB03		TSB		15.3.2004
	NULL	04HY14AHLA002-CHASSIS	04W1E	16	WH							FRM GND			TSB		15.3.2004
4	NULL	04HY14AHLA003-01	04A681-K02-04	16	WH	1N						220VACN	04A550CB04		TSB		15.3.2004
	NULL	04HY14AHLA003-01	04HY14AHLA004-01	16	WH	1N						220VACN	04A550CB04		TSB		15.3.2004
4	NULL	04HY14AHLA003-03	04A681-K01-04	16	WH	1N						220VACN	04A550CB04		TSB		15.3.2004
	NULL	04HY14AHLA003-03	04HY14AHLA004-03	16	WH	1N						220VACN	04A550CB04		TSB		15.3.2004
	NULL	04HY14AHLA003-04	04A805-TB POWER-02	16	BK	1N						220 VAC	04A550CB04		TSB		15.3.2004
	NULL	04HY14AHLA003-CHASSIS	04W1E	16	WH							FRM GND			TSB		15.3.2004
	NULL	04HY14AHLA004-01	04HY14AHLA005-01	16	WH	1N						220VACN	04A550CB04		TSB		15.3.2004
	NULL	04HY14AHLA004-03	04HY14AHLA005-03	16	WH	1N						220VACN	04A550CB04		TSB		15.3.2004
	NULL	04HY14AHLA004-04	04A805-TB POWER-04	16	BK	1N						220 VAC	04A550CB04		TSB		15.3.2004
	NULL	04HY14AHLA004-CHASSIS	04W1E	16	WH							FRM GND			TSB		15.3.2004
	NULL	04HY14AHLA005-01	04HY14AHLA006-01	16	WH	1N						220VACN	04A550CB04		TSB		15.3.2004
	NULL	04HY14AHLA005-03	04HY14AHLA006-03	16	WH	1N						220VACN	04A550CB04		TSB		15.3.2004
	NULL	04HY14AHLA005-04	04A805-TB POWER-06	16	BK	1N						220 VAC	04A550CB04		TSB		15.3.2004
	NULL	04HY14AHLA005-CHASSIS	04W1E	16	WH							FRM GND			TSB		15.3.2004
	NULL	04HY14AHLA006-01	04HY14AHLA007-01	16	WH	1N						220VACN	04A550CB04		TSB		15.3.2004
	NULL	04HY14AHLA006-03	04HY14AHLA007-03	16	WH	1N						220VACN	04A550CB04		TSB		15.3.2004
	NULL	04HY14AHLA006-04	04A805-TB POWER-08	16	BK	1N						220 VAC	04A550CB04		TSB		15.3.2004
	NULL	04HY14AHLA006-CHASSIS	04W1E	16	WH							FRM GND			TSB		15.3.2004
	NULL	04HY14AHLA007-01	04HY14AHLA008-01	16	WH	1N						220VACN	04A550CB04		TSB		15.3.2004
	NULL	04HY14AHLA007-03	04HY14AHLA008-03	16	WH	1N						220VACN	04A550CB04		TSB		15.3.2004
	NULL	04HY14AHLA007-04	04A805-TB POWER-10	16	BK	1N						220 VAC	04A550CB04		TSB		15.3.2004
	NULL	04HY14AHLA007-CHASSIS	04W1E	16	WH							FRM GND			TSB		15.3.2004
	NULL	04HY14AHLA008-01	04HY14AHLA009-01	16	WH	1N						220VACN	04A550CB04		TSB		15.3.2004
	NULL	04HY14AHLA008-03	04HY14AHLA009-03	16	WH	1N						220VACN	04A550CB04		TSB		15.3.2004
	NULL	04HY14AHLA008-04	04A805-TB POWER-12	16	BK	1N						220 VAC	04A550CB04		TSB		15.3.2004
	NULL	04HY14AHLA008-CHASSIS	04W1E	16	WH							FRM GND			TSB		15.3.2004
	NULL	04HY14AHLA009-01	04HY14AHLA010-01	16	WH	1N						220VACN	04A550CB04		TSB		15.3.2004
	NULL	04HY14AHLA009-03	04HY14AHLA010-03	16	WH	1N						220VACN	04A550CB04		TSB		15.3.2004

coord	coord_	From	To	WC	CC	NC	IO	SC	Word	bit	remarks	power	origin	daisy_	ped	rev_le	write_date
	NULL	04HY14AHLA009-04	04A805-TB POWER-14	16	BK	1N						220 VAC	04A550CB04		TSB		15.3.2004
	NULL	04HY14AHLA009-CHASSIS	04W1E	16	WH							FRM GND			TSB		15.3.2004
	NULL	04HY14AHLA010-01	04HY14AHLA011-01	16	WH	1N						220VACN	04A550CB04		TSB		15.3.2004
	NULL	04HY14AHLA010-03	04HY14AHLA011-03	16	WH	1N						220VACN	04A550CB04		TSB		15.3.2004
	NULL	04HY14AHLA010-04	04A805-TB POWER-16	16	BK	1N						220 VAC	04A550CB04		TSB		15.3.2004
	NULL	04HY14AHLA010-CHASSIS	04W1E	16	WH							FRM GND			TSB		15.3.2004
	NULL	04HY14AHLA011-01	04HY14AHLA012-01	16	WH	1N						220VACN	04A550CB04		TSB		15.3.2004
	NULL	04HY14AHLA011-03	04HY14AHLA012-03	16	WH	1N						220VACN	04A550CB04		TSB		15.3.2004
	NULL	04HY14AHLA011-04	04A805-TB POWER-18	16	BK	1N						220 VAC	04A550CB04		TSB		15.3.2004
	NULL	04HY14AHLA011-CHASSIS	04W1E	16	WH							FRM GND			TSB		15.3.2004
	NULL	04HY14AHLA012-01	04HY14AHLA013-01	16	WH	1N						220VACN	04A550CB04		TSB		15.3.2004
	NULL	04HY14AHLA012-03	04HY14AHLA013-03	16	WH	1N						220VACN	04A550CB04		TSB		15.3.2004
	NULL	04HY14AHLA012-04	04A805-TB POWER-20	16	BK	1N						220 VAC	04A550CB04		TSB		15.3.2004
	NULL	04HY14AHLA012-CHASSIS	04W1E	16	WH							FRM GND			TSB		15.3.2004
	NULL	04HY14AHLA013-01	04HY14AHLA014-01	16	WH	1N						220VACN	04A550CB04		TSB		15.3.2004
	NULL	04HY14AHLA013-03	04HY14AHLA014-03	16	WH	1N						220VACN	04A550CB04		TSB		15.3.2004
	NULL	04HY14AHLA013-04	04A805-TB POWER-22	16	BK	1N						220 VAC	04A550CB04		TSB		15.3.2004
	NULL	04HY14AHLA013-CHASSIS	04W1E	16	WH							FRM GND			TSB		15.3.2004
	NULL	04HY14AHLA014-01	04HY14AHLA015-01	16	WH	1N						220VACN	04A550CB04		TSB		15.3.2004
	NULL	04HY14AHLA014-03	04HY14AHLA015-03	16	WH	1N						220VACN	04A550CB04		TSB		15.3.2004
	NULL	04HY14AHLA014-04	04A805-TB POWER-24	16	BK	1N						220 VAC	04A550CB04		TSB		15.3.2004
	NULL	04HY14AHLA014-CHASSIS	04W1E	16	WH							FRM GND			TSB		15.3.2004
	NULL	04HY14AHLA015-01	04HY14AHLA016-01	16	WH	1N						220VACN	04A550CB04		TSB		15.3.2004
	NULL	04HY14AHLA015-03	04HY14AHLA016-03	16	WH	1N						220VACN	04A550CB04		TSB		15.3.2004
	NULL	04HY14AHLA015-04	04A805-TB POWER-26	16	BK	1N						220 VAC	04A550CB04		TSB		15.3.2004
	NULL	04HY14AHLA015-CHASSIS	04W1E	16	WH							FRM GND			TSB		15.3.2004
	NULL	04HY14AHLA016-01	04HY14AHLA017-01	16	WH	1N						220VACN	04A550CB04		TSB		15.3.2004
	NULL	04HY14AHLA016-03	04HY14AHLA017-03	16	WH	1N						220VACN	04A550CB04		TSB		15.3.2004
	NULL	04HY14AHLA016-04	04A805-TB POWER-28	16	BK	1N						220 VAC	04A550CB04		TSB		15.3.2004
	NULL	04HY14AHLA016-CHASSIS	04W1E	16	WH							FRM GND			TSB		15.3.2004
	NULL	04HY14AHLA017-01	04HY14AHLA018-01	16	WH	1N						220VACN	04A550CB04		TSB		15.3.2004
	NULL	04HY14AHLA017-03	04HY14AHLA018-03	16	WH	1N						220VACN	04A550CB04		TSB		15.3.2004
	NULL	04HY14AHLA017-04	04A805-TB POWER-30	16	BK	1N						220 VAC	04A550CB04		TSB		15.3.2004
	NULL	04HY14AHLA017-CHASSIS	04W1E	16	WH							FRM GND			TSB		15.3.2004
	NULL	04HY14AHLA018-04	04A805-TB POWER-32	16	BK	1N						220 VAC	04A550CB04		TSB		15.3.2004
	NULL	04HY14AHLA018-CHASSIS	04W1E	16	WH							FRM GND			TSB		15.3.2004
	NULL	04A804-TB SIGNAL-30	04A530-A2P07-15	22	WH		LO	4	004	14	04HY14AHLA001				TSB		15.3.2004
	NULL	04A804-TB SIGNAL-32	04A530-A2P07-16	22	WH		LO	4	004	15	04HY14AHLA002				TSB		15.3.2004
	NULL	04A805-TB SIGNAL-02	04A530-A2P08-01	22	WH		LO	4	005	00	04HY14AHLA003				TSB		15.3.2004
	NULL	04A805-TB SIGNAL-04	04A530-A2P08-02	22	WH		LO	4	005	01	04HY14AHLA004				TSB		15.3.2004
	NULL	04A805-TB SIGNAL-06	04A530-A2P08-03	22	WH		LO	4	005	02	04HY14AHLA005				TSB		15.3.2004
	NULL	04A805-TB SIGNAL-08	04A530-A2P08-04	22	WH		LO	4	005	03	04HY14AHLA006				TSB		15.3.2004
	NULL	04A805-TB SIGNAL-10	04A530-A2P08-05	22	WH		LO	4	005	04	04HY14AHLA007				TSB		15.3.2004
	NULL	04A805-TB SIGNAL-12	04A530-A2P08-06	22	WH		LO	4	005	05	04HY14AHLA008				TSB		15.3.2004
	NULL	04A805-TB SIGNAL-14	04A530-A2P08-07	22	WH		LO	4	005	06	04HY14AHLA009				TSB		15.3.2004
	NULL	04A805-TB SIGNAL-16	04A530-A2P08-08	22	WH		LO	4	005	07	04HY14AHLA010				TSB		15.3.2004
	NULL	04A805-TB SIGNAL-18	04A530-A2P08-09	22	WH		LO	4	005	08	04HY14AHLA011				TSB		15.3.2004
	NULL	04A805-TB SIGNAL-20	04A530-A2P08-10	22	WH		LO	4	005	09	04HY14AHLA012				TSB		15.3.2004
	NULL	04A805-TB SIGNAL-22	04A530-A2P08-11	22	WH		LO	4	005	10	04HY14AHLA013				TSB		15.3.2004
	NULL	04A805-TB SIGNAL-24	04A530-A2P08-12	22	WH		LO	4	005	11	04HY14AHLA014				TSB		15.3.2004
	NULL	04A805-TB SIGNAL-26	04A530-A2P08-13	22	WH		LO	4	005	12	04HY14AHLA015				TSB		15.3.2004
	NULL	04A805-TB SIGNAL-28	04A530-A2P08-14	22	WH		LO	4	005	13	04HY14AHLA016				TSB		15.3.2004
	NULL	04A805-TB SIGNAL-30	04A530-A2P08-15	22	WH		LO	4	005	14	04HY14AHLA017				TSB		15.3.2004

coord	coord_	From	To	WC	CC	NC	IO	SC	Word	bit	remarks	power	origin	daisy_	ped	rev_le	write_date
	NULL	04A805-TB SIGNAL-32	04A530-A2P08-16	22	WH		LO	4	005	15	04HY14AHLA018				TSB		15.3.2004
HY25																	
	NULL	04HY025HLA001-01	04HY025HLA002-01	16	WH	1N						220VACN	04A550CB04		TSB		15.3.2004
	NULL	04HY025HLA001-03	04HY025HLA002-03	16	WH	1N						220VACN	04A550CB04		TSB		15.3.2004
	NULL	04HY025HLA001-04	04A806-TB POWER-02	16	BK	1N						220 VAC	04A550CB04		TSB		15.3.2004
	NULL	04HY025HLA001-CHASSIS	04W1F	16	WH							FRM GND			TSB		15.3.2004
	NULL	04HY025HLA002-01	04HY025HLA003-01	16	WH	1N						220VACN	04A550CB04		TSB		15.3.2004
	NULL	04HY025HLA002-03	04HY025HLA003-03	16	WH	1N						220VACN	04A550CB04		TSB		15.3.2004
	NULL	04HY025HLA002-04	04A806-TB POWER-04	16	BK	1N						220 VAC	04A550CB04		TSB		15.3.2004
	NULL	04HY025HLA002-CHASSIS	04W1F	16	WH							FRM GND			TSB		15.3.2004
	NULL	04HY025HLA003-01	04HY025HLA004-01	16	WH	1N						220VACN	04A550CB04		TSB		15.3.2004
	NULL	04HY025HLA003-03	04HY025HLA004-03	16	WH	1N						220VACN	04A550CB04		TSB		15.3.2004
	NULL	04HY025HLA003-04	04A806-TB POWER-06	16	BK	1N						220 VAC	04A550CB04		TSB		15.3.2004
	NULL	04HY025HLA003-CHASSIS	04W1F	16	WH							FRM GND			TSB		15.3.2004
	NULL	04HY025HLA004-01	04HY025HLA005-01	16	WH	1N						220VACN	04A550CB04		TSB		15.3.2004
	NULL	04HY025HLA004-03	04HY025HLA005-03	16	WH	1N						220VACN	04A550CB04		TSB		15.3.2004
	NULL	04HY025HLA004-04	04A806-TB POWER-08	16	BK	1N						220 VAC	04A550CB04		TSB		15.3.2004
	NULL	04HY025HLA004-CHASSIS	04W1F	16	WH							FRM GND			TSB		15.3.2004
	NULL	04HY025HLA005-01	04HY025HLA006-01	16	WH	1N						220VACN	04A550CB04		TSB		15.3.2004
	NULL	04HY025HLA005-03	04HY025HLA006-03	16	WH	1N						220VACN	04A550CB04		TSB		15.3.2004
	NULL	04HY025HLA005-04	04A806-TB POWER-10	16	BK	1N						220 VAC	04A550CB04		TSB		15.3.2004
	NULL	04HY025HLA005-CHASSIS	04W1F	16	WH							FRM GND			TSB		15.3.2004
	NULL	04HY025HLA006-01	04HY025HLA007-01	16	WH	1N						220VACN	04A550CB04		TSB		15.3.2004
	NULL	04HY025HLA006-03	04HY025HLA007-03	16	WH	1N						220VACN	04A550CB04		TSB		15.3.2004
	NULL	04HY025HLA006-04	04A806-TB POWER-12	16	BK	1N						220 VAC	04A550CB04		TSB		15.3.2004
	NULL	04HY025HLA006-CHASSIS	04W1F	16	WH							FRM GND			TSB		15.3.2004
	NULL	04HY025HLA007-01	04HY025HLA008-01	16	WH	1N						220VACN	04A550CB04		TSB		15.3.2004
	NULL	04HY025HLA007-03	04HY025HLA008-03	16	WH	1N						220VACN	04A550CB04		TSB		15.3.2004
	NULL	04HY025HLA007-04	04A806-TB POWER-14	16	BK	1N						220 VAC	04A550CB04		TSB		15.3.2004
	NULL	04HY025HLA007-CHASSIS	04W1F	16	WH							FRM GND			TSB		15.3.2004
	NULL	04HY025HLA008-01	04HY025HLA009-01	16	WH	1N						220VACN	04A550CB04		TSB		15.3.2004
	NULL	04HY025HLA008-03	04HY025HLA009-03	16	WH	1N						220VACN	04A550CB04		TSB		15.3.2004
	NULL	04HY025HLA008-04	04A806-TB POWER-16	16	BK	1N						220 VAC	04A550CB04		TSB		15.3.2004
	NULL	04HY025HLA008-CHASSIS	04W1F	16	WH							FRM GND			TSB		15.3.2004
	NULL	04HY025HLA009-01	04HY025HLA010-01	16	WH	1N						220VACN	04A550CB04		TSB		15.3.2004
	NULL	04HY025HLA009-03	04HY025HLA010-03	16	WH	1N						220VACN	04A550CB04		TSB		15.3.2004
	NULL	04HY025HLA009-04	04A806-TB POWER-18	16	BK	1N						220 VAC	04A550CB04		TSB		15.3.2004
	NULL	04HY025HLA009-CHASSIS	04W1F	16	WH							FRM GND			TSB		15.3.2004
	NULL	04HY025HLA010-01	04HY025HLA011-01	16	WH	1N						220VACN	04A550CB04		TSB		15.3.2004
	NULL	04HY025HLA010-03	04HY025HLA011-03	16	WH	1N						220VACN	04A550CB04		TSB		15.3.2004
	NULL	04HY025HLA010-04	04A806-TB POWER-20	16	BK	1N						220 VAC	04A550CB04		TSB		15.3.2004
	NULL	04HY025HLA010-CHASSIS	04W1F	16	WH							FRM GND			TSB		15.3.2004
	NULL	04HY025HLA011-01	04HY025HLA012-01	16	WH	1N						220VACN	04A550CB04		TSB		15.3.2004
	NULL	04HY025HLA011-03	04HY025HLA012-03	16	WH	1N						220VACN	04A550CB04		TSB		15.3.2004
	NULL	04HY025HLA011-04	04A806-TB POWER-22	16	BK	1N						220 VAC	04A550CB04		TSB		15.3.2004
	NULL	04HY025HLA011-CHASSIS	04W1F	16	WH							FRM GND			TSB		15.3.2004
	NULL	04HY025HLA012-01	04HY025HLA013-01	16	WH	1N						220VACN	04A550CB04		TSB		15.3.2004
	NULL	04HY025HLA012-03	04HY025HLA013-03	16	WH	1N						220VACN	04A550CB04		TSB		15.3.2004
	NULL	04HY025HLA012-04	04A806-TB POWER-24	16	BK	1N						220 VAC	04A550CB04		TSB		15.3.2004
	NULL	04HY025HLA012-CHASSIS	04W1F	16	WH							FRM GND			TSB		15.3.2004
	NULL	04HY025HLA013-01	04HY025HLA014-01	16	WH	1N						220VACN	04A550CB04		TSB		15.3.2004
	NULL	04HY025HLA013-03	04HY025HLA014-03	16	WH	1N						220VACN	04A550CB04		TSB		15.3.2004
	NULL	04HY025HLA013-04	04A806-TB POWER-26	16	BK	1N						220 VAC	04A550CB04		TSB		15.3.2004
	NULL	04HY025HLA013-CHASSIS	04W1F	16	WH							FRM GND			TSB		15.3.2004

coord	coord_	From	To	WC	CC	NC	IO	SC	Word	bit	remarks	power	origin	daisy_	ped	rev_le	write_date
	NULL	04HY025HLA014-01	04HY025HLA015-01	16	WH	1N						220VACN	04A550CB04		TSB		15.3.2004
	NULL	04HY025HLA014-03	04HY025HLA015-03	16	WH	1N						220VACN	04A550CB04		TSB		15.3.2004
	NULL	04HY025HLA014-04	04A806-TB POWER-28	16	BK	1N						220 VAC	04A550CB04		TSB		15.3.2004
	NULL	04HY025HLA014-CHASSIS	04W1F	16	WH							FRM GND			TSB		15.3.2004
	NULL	04HY025HLA015-01	04HY025HLA016-01	16	WH	1N						220VACN	04A550CB04		TSB		15.3.2004
	NULL	04HY025HLA015-03	04HY025HLA016-03	16	WH	1N						220VACN	04A550CB04		TSB		15.3.2004
	NULL	04HY025HLA015-04	04A806-TB POWER-30	16	BK	1N						220 VAC	04A550CB04		TSB		15.3.2004
	NULL	04HY025HLA015-CHASSIS	04W1F	16	WH							FRM GND			TSB		15.3.2004
	NULL	04HY025HLA016-01	04HY025HLA017-01	16	WH	1N						220VACN	04A550CB04		TSB		15.3.2004
	NULL	04HY025HLA016-03	04HY025HLA017-03	16	WH	1N						220VACN	04A550CB04		TSB		15.3.2004
	NULL	04HY025HLA016-04	04A806-TB POWER-32	16	BK	1N						220 VAC	04A550CB04		TSB		15.3.2004
	NULL	04HY025HLA016-CHASSIS	04W1F	16	WH							FRM GND			TSB		15.3.2004
	NULL	04HY025HLA017-01	04HY025HLA018-01	16	WH	1N						220VACN	04A550CB04		TSB		15.3.2004
	NULL	04HY025HLA017-03	04HY025HLA018-03	16	WH	1N						220VACN	04A550CB04		TSB		15.3.2004
	NULL	04HY025HLA017-04	04A807-TB POWER-02	16	BK	1N						220 VAC	04A550CB04		TSB		15.3.2004
	NULL	04HY025HLA017-CHASSIS	04W1F	16	WH							FRM GND			TSB		15.3.2004
	NULL	04HY025HLA018-01	04A683-K02-05	16	WH	1N						220VACN	04A550CB04		TSB	A	15.3.2004
	NULL	04HY025HLA018-03	04A680-K14-NC	16	WH	1N						220VACN	04A550CB04		TSB	A	15.3.2004
	NULL	04HY025HLA018-04	04A807-TB POWER-04	16	BK	1N						220 VAC	04A550CB04		TSB		15.3.2004
	NULL	04HY025HLA018-CHASSIS	04W1F	16	WH							FRM GND			TSB		15.3.2004
4	NULL	04HY025HLA019-01	04A683-K03-05	16	WH	1N						220VACN	04A550CB04		TSB	A	15.3.2004
	NULL	04HY025HLA019-01	04HY025HLA020-01	16	WH	1N						220VACN	04A550CB04		TSB		15.3.2004
4	NULL	04HY025HLA019-03	04A680-K02-05	16	WH	1N						220VACN	04A550CB04		TSB	A	15.3.2004
	NULL	04HY025HLA019-03	04HY025HLA020-03	16	WH	1N						220VACN	04A550CB04		TSB		15.3.2004
	NULL	04HY025HLA019-04	04A807-TB POWER-06	16	BK	1N						220 VAC	04A550CB04		TSB		15.3.2004
	NULL	04HY025HLA019-CHASSIS	04W1G	16	WH							FRM GND			TSB		15.3.2004
	NULL	04HY025HLA020-01	04HY025HLA021-01	16	WH	1N						220VACN	04A550CB04		TSB		15.3.2004
	NULL	04HY025HLA020-03	04HY025HLA021-03	16	WH	1N						220VACN	04A550CB04		TSB		15.3.2004
	NULL	04HY025HLA020-04	04A807-TB POWER-08	16	BK	1N						220 VAC	04A550CB04		TSB		15.3.2004
	NULL	04HY025HLA020-CHASSIS	04W1G	16	WH							FRM GND			TSB		15.3.2004
	NULL	04HY025HLA021-01	04HY025HLA022-01	16	WH	1N						220VACN	04A550CB04		TSB		15.3.2004
	NULL	04HY025HLA021-03	04HY025HLA022-03	16	WH	1N						220VACN	04A550CB04		TSB		15.3.2004
	NULL	04HY025HLA021-04	04A807-TB POWER-10	16	BK	1N						220 VAC	04A550CB04		TSB		15.3.2004
	NULL	04HY025HLA021-CHASSIS	04W1G	16	WH							FRM GND			TSB		15.3.2004
	NULL	04HY025HLA022-01	04HY025HLA023-01	16	WH	1N						220VACN	04A550CB04		TSB		15.3.2004
	NULL	04HY025HLA022-03	04HY025HLA023-03	16	WH	1N						220VACN	04A550CB04		TSB		15.3.2004
	NULL	04HY025HLA022-04	04A807-TB POWER-12	16	BK	1N						220 VAC	04A550CB04		TSB		15.3.2004
	NULL	04HY025HLA022-CHASSIS	04W1G	16	WH							FRM GND			TSB		15.3.2004
	NULL	04HY025HLA023-01	04HY025HLA024-01	16	WH	1N						220VACN	04A550CB04		TSB		15.3.2004
	NULL	04HY025HLA023-03	04HY025HLA024-03	16	WH	1N						220VACN	04A550CB04		TSB		15.3.2004
	NULL	04HY025HLA023-04	04A807-TB POWER-14	16	BK	1N						220 VAC	04A550CB04		TSB		15.3.2004
	NULL	04HY025HLA023-CHASSIS	04W1G	16	WH							FRM GND			TSB		15.3.2004
	NULL	04HY025HLA024-01	04HY025HLA025-01	16	WH	1N						220VACN	04A550CB04		TSB		15.3.2004
	NULL	04HY025HLA024-03	04HY025HLA025-03	16	WH	1N						220VACN	04A550CB04		TSB		15.3.2004
	NULL	04HY025HLA024-04	04A807-TB POWER-16	16	BK	1N						220 VAC	04A550CB04		TSB		15.3.2004
	NULL	04HY025HLA024-CHASSIS	04W1G	16	WH							FRM GND			TSB		15.3.2004
	NULL	04HY025HLA025-01	04HY025HLA026-01	16	WH	1N						220VACN	04A550CB04		TSB		15.3.2004
	NULL	04HY025HLA025-03	04HY025HLA026-03	16	WH	1N						220VACN	04A550CB04		TSB		15.3.2004
	NULL	04HY025HLA025-04	04A807-TB POWER-18	16	BK	1N						220 VAC	04A550CB04		TSB		15.3.2004
	NULL	04HY025HLA025-CHASSIS	04W1G	16	WH							FRM GND			TSB		15.3.2004
	NULL	04HY025HLA026-01	04HY025HLA027-01	16	WH	1N						220VACN	04A550CB04		TSB		15.3.2004
	NULL	04HY025HLA026-03	04HY025HLA027-03	16	WH	1N						220VACN	04A550CB04		TSB		15.3.2004
	NULL	04HY025HLA026-04	04A807-TB POWER-20	16	BK	1N						220 VAC	04A550CB04		TSB		15.3.2004
	NULL	04HY025HLA026-CHASSIS	04W1G	16	WH							FRM GND			TSB		15.3.2004

coord	coord_	From	To	WC	CC	NC	IO	SC	Word	bit	remarks	power	origin	daisy_	ped	rev_le	write_date
	NULL	04HY025HLA027-01	04HY025HLA028-01	16	WH	1N						220VACN	04A550CB04		TSB		15.3.2004
	NULL	04HY025HLA027-03	04HY025HLA028-03	16	WH	1N						220VACN	04A550CB04		TSB		15.3.2004
	NULL	04HY025HLA027-04	04A807-TB POWER-22	16	BK	1N						220 VAC	04A550CB04		TSB		15.3.2004
	NULL	04HY025HLA027-CHASSIS	04W1G	16	WH							FRM GND			TSB		15.3.2004
	NULL	04HY025HLA028-01	04HY025HLA029-01	16	WH	1N						220VACN	04A550CB04		TSB		15.3.2004
	NULL	04HY025HLA028-03	04HY025HLA029-03	16	WH	1N						220VACN	04A550CB04		TSB		15.3.2004
	NULL	04HY025HLA028-04	04A807-TB POWER-24	16	BK	1N						220 VAC	04A550CB04		TSB		15.3.2004
	NULL	04HY025HLA028-CHASSIS	04W1G	16	WH							FRM GND			TSB		15.3.2004
	NULL	04HY025HLA029-01	04HY025HLA030-01	16	WH	1N						220VACN	04A550CB04		TSB		15.3.2004
	NULL	04HY025HLA029-03	04HY025HLA030-03	16	WH	1N						220VACN	04A550CB04		TSB		15.3.2004
	NULL	04HY025HLA029-04	04A807-TB POWER-26	16	BK	1N						220 VAC	04A550CB04		TSB		15.3.2004
	NULL	04HY025HLA029-CHASSIS	04W1G	16	WH							FRM GND			TSB		15.3.2004
	NULL	04HY025HLA030-01	04HY025HLA031-01	16	WH	1N						220VACN	04A550CB04		TSB		15.3.2004
	NULL	04HY025HLA030-03	04HY025HLA031-03	16	WH	1N						220VACN	04A550CB04		TSB		15.3.2004
	NULL	04HY025HLA030-04	04A807-TB POWER-28	16	BK	1N						220 VAC	04A550CB04		TSB		15.3.2004
	NULL	04HY025HLA030-CHASSIS	04W1G	16	WH							FRM GND			TSB		15.3.2004
	NULL	04HY025HLA031-01	04HY025HLA032-01	16	WH	1N						220VACN	04A550CB04		TSB		15.3.2004
	NULL	04HY025HLA031-03	04HY025HLA032-03	16	WH	1N						220VACN	04A550CB04		TSB		15.3.2004
	NULL	04HY025HLA031-04	04A807-TB POWER-30	16	BK	1N						220 VAC	04A550CB04		TSB		15.3.2004
	NULL	04HY025HLA031-CHASSIS	04W1G	16	WH							FRM GND			TSB		15.3.2004
	NULL	04HY025HLA032-01	04HY025HLA033-01	16	WH	1N						220VACN	04A550CB04		TSB		15.3.2004
	NULL	04HY025HLA032-03	04HY025HLA033-03	16	WH	1N						220VACN	04A550CB04		TSB		15.3.2004
	NULL	04HY025HLA032-04	04A807-TB POWER-32	16	BK	1N						220 VAC	04A550CB04		TSB		15.3.2004
	NULL	04HY025HLA032-CHASSIS	04W1G	16	WH							FRM GND			TSB		15.3.2004
	NULL	04HY025HLA033-01	04HY025HLA034-01	16	WH	1N						220VACN	04A550CB04		TSB		15.3.2004
	NULL	04HY025HLA033-03	04HY025HLA034-03	16	WH	1N						220VACN	04A550CB04		TSB		15.3.2004
	NULL	04HY025HLA033-04	04A808-TB POWER-02	16	BK	1N						220 VAC	04A550CB04		TSB		15.3.2004
	NULL	04HY025HLA033-CHASSIS	04W1G	16	WH							FRM GND			TSB		15.3.2004
	NULL	04HY025HLA034-01	04HY025HLA035-01	16	WH	1N						220VACN	04A550CB04		TSB		15.3.2004
	NULL	04HY025HLA034-03	04HY025HLA035-03	16	WH	1N						220VACN	04A550CB04		TSB		15.3.2004
	NULL	04HY025HLA034-04	04A808-TB POWER-04	16	BK	1N						220 VAC	04A550CB04		TSB		15.3.2004
	NULL	04HY025HLA034-CHASSIS	04W1G	16	WH							FRM GND			TSB		15.3.2004
	NULL	04HY025HLA035-01	04HY025HLA036-01	16	WH	1N						220VACN	04A550CB04		TSB		15.3.2004
	NULL	04HY025HLA035-03	04HY025HLA036-03	16	WH	1N						220VACN	04A550CB04		TSB		15.3.2004
	NULL	04HY025HLA035-04	04A808-TB POWER-06	16	BK	1N						220 VAC	04A550CB04		TSB		15.3.2004
	NULL	04HY025HLA035-CHASSIS	04W1G	16	WH							FRM GND			TSB		15.3.2004
	NULL	04HY025HLA036-01	04HY025HLA037-01	16	WH	1N						220VACN	04A550CB04		TSB		15.3.2004
	NULL	04HY025HLA036-03	04HY025HLA037-03	16	WH	1N						220VACN	04A550CB04		TSB		15.3.2004
	NULL	04HY025HLA036-04	04A808-TB POWER-08	16	BK	1N						220 VAC	04A550CB04		TSB		15.3.2004
	NULL	04HY025HLA036-CHASSIS	04W1G	16	WH							FRM GND			TSB		15.3.2004
	NULL	04HY025HLA037-01	04HY025HLA038-01	16	WH	1N						220VACN	04A550CB04		TSB		15.3.2004
	NULL	04HY025HLA037-03	04HY025HLA038-03	16	WH	1N						220VACN	04A550CB04		TSB		15.3.2004
	NULL	04HY025HLA037-04	04A808-TB POWER-10	16	BK	1N						220 VAC	04A550CB04		TSB		15.3.2004
	NULL	04HY025HLA037-CHASSIS	04W1G	16	WH							FRM GND			TSB		15.3.2004
	NULL	04HY025HLA038-01	04HY025HLA039-01	16	WH	1N						220VACN	04A550CB04		TSB		15.3.2004
	NULL	04HY025HLA038-03	04HY025HLA039-03	16	WH	1N						220VACN	04A550CB04		TSB		15.3.2004
	NULL	04HY025HLA038-04	04A808-TB POWER-12	16	BK	1N						220 VAC	04A550CB04		TSB		15.3.2004
	NULL	04HY025HLA038-CHASSIS	04W1G	16	WH							FRM GND			TSB		15.3.2004
	NULL	04HY025HLA039-01	04HY025HLA040-01	16	WH	1N						220VACN	04A550CB04		TSB		15.3.2004
	NULL	04HY025HLA039-03	04HY025HLA040-03	16	WH	1N						220VACN	04A550CB04		TSB		15.3.2004
	NULL	04HY025HLA039-04	04A808-TB POWER-14	16	BK	1N						220 VAC	04A550CB04		TSB		15.3.2004
	NULL	04HY025HLA039-CHASSIS	04W1G	16	WH							FRM GND			TSB		15.3.2004
	NULL	04HY025HLA040-01	04HY025HLA041-01	16	WH	1N						220VACN	04A550CB04		TSB		15.3.2004
	NULL	04HY025HLA040-03	04HY025HLA041-03	16	WH	1N						220VACN	04A550CB04		TSB		15.3.2004

coord	coord_	From	To	WC	CC	NC	IO	SC	Word	bit	remarks	power	origin	daisy_	ped	rev_le	write_date
	NULL	04HY025HLA040-04	04A808-TB POWER-16	16	BK	1N						220 VAC	04A550CB04		TSB		15.3.2004
	NULL	04HY025HLA040-CHASSIS	04W1G	16	WH							FRM GND			TSB		15.3.2004
	NULL	04HY025HLA041-01	04HY025HLA042-01	16	WH	1N						220VACN	04A550CB04		TSB		15.3.2004
	NULL	04HY025HLA041-03	04HY025HLA042-03	16	WH	1N						220VACN	04A550CB04		TSB		15.3.2004
	NULL	04HY025HLA041-04	04A808-TB POWER-18	16	BK	1N						220 VAC	04A550CB04		TSB		15.3.2004
	NULL	04HY025HLA041-CHASSIS	04W1G	16	WH							FRM GND			TSB		15.3.2004
	NULL	04HY025HLA042-01	04HY025HLA043-01	16	WH	1N						220VACN	04A550CB04		TSB		15.3.2004
	NULL	04HY025HLA042-03	04HY025HLA043-03	16	WH	1N						220VACN	04A550CB04		TSB		15.3.2004
	NULL	04HY025HLA042-04	04A808-TB POWER-20	16	BK	1N						220 VAC	04A550CB04		TSB		15.3.2004
	NULL	04HY025HLA042-CHASSIS	04W1G	16	WH							FRM GND			TSB		15.3.2004
	NULL	04HY025HLA043-01	04HY025HLA044-01	16	WH	1N						220VACN	04A550CB04		TSB		15.3.2004
	NULL	04HY025HLA043-03	04HY025HLA044-03	16	WH	1N						220VACN	04A550CB04		TSB		15.3.2004
	NULL	04HY025HLA043-04	04A808-TB POWER-22	16	BK	1N						220 VAC	04A550CB04		TSB		15.3.2004
	NULL	04HY025HLA043-CHASSIS	04W1G	16	WH							FRM GND			TSB		15.3.2004
	NULL	04HY025HLA044-01	04HY025HLA045-01	16	WH	1N						220VACN	04A550CB04		TSB		15.3.2004
	NULL	04HY025HLA044-03	04HY025HLA045-03	16	WH	1N						220VACN	04A550CB04		TSB		15.3.2004
	NULL	04HY025HLA044-04	04A808-TB POWER-24	16	BK	1N						220 VAC	04A550CB04		TSB		15.3.2004
	NULL	04HY025HLA044-CHASSIS	04W1G	16	WH							FRM GND			TSB		15.3.2004
	NULL	04HY025HLA045-01	04HY025HLA046-01	16	WH	1N						220VACN	04A550CB04		TSB		15.3.2004
	NULL	04HY025HLA045-03	04HY025HLA046-03	16	WH	1N						220VACN	04A550CB04		TSB		15.3.2004
	NULL	04HY025HLA045-04	04A808-TB POWER-26	16	BK	1N						220 VAC	04A550CB04		TSB		15.3.2004
	NULL	04HY025HLA045-CHASSIS	04W1G	16	WH							FRM GND			TSB		15.3.2004
	NULL	04HY025HLA046-01	04HY025HLA047-01	16	WH	1N						220VACN	04A550CB04		TSB		15.3.2004
	NULL	04HY025HLA046-03	04HY025HLA047-03	16	WH	1N						220VACN	04A550CB04		TSB		15.3.2004
	NULL	04HY025HLA046-04	04A808-TB POWER-28	16	BK	1N						220 VAC	04A550CB04		TSB		15.3.2004
	NULL	04HY025HLA046-CHASSIS	04W1H	16	WH							FRM GND			TSB		15.3.2004
	NULL	04HY025HLA047-01	04HY025HLA048-01	16	WH	1N						220VACN	04A550CB04		TSB		15.3.2004
	NULL	04HY025HLA047-03	04HY025HLA048-03	16	WH	1N						220VACN	04A550CB04		TSB		15.3.2004
	NULL	04HY025HLA047-04	04A808-TB POWER-30	16	BK	1N						220 VAC	04A550CB04		TSB		15.3.2004
	NULL	04HY025HLA047-CHASSIS	04W1H	16	WH							FRM GND			TSB		15.3.2004
	NULL	04HY025HLA048-01	04HY025HLA049-01	16	WH	1N						220VACN	04A550CB04		TSB		15.3.2004
	NULL	04HY025HLA048-03	04HY025HLA049-03	16	WH	1N						220VACN	04A550CB04		TSB		15.3.2004
	NULL	04HY025HLA048-04	04A808-TB POWER-32	16	BK	1N						220 VAC	04A550CB04		TSB		15.3.2004
	NULL	04HY025HLA048-CHASSIS	04W1H	16	WH							FRM GND			TSB		15.3.2004
	NULL	04HY025HLA049-01	04HY025HLA050-01	16	WH	1N						220VACN	04A550CB04		TSB		15.3.2004
	NULL	04HY025HLA049-03	04HY025HLA050-03	16	WH	1N						220VACN	04A550CB04		TSB		15.3.2004
	NULL	04HY025HLA049-04	04A809-TB POWER-02	16	BK	1N						220 VAC	04A550CB04		TSB		15.3.2004
	NULL	04HY025HLA049-CHASSIS	04W1H	16	WH							FRM GND			TSB		15.3.2004
	NULL	04HY025HLA050-01	04HY025HLA051-01	16	WH	1N						220VACN	04A550CB04		TSB		15.3.2004
	NULL	04HY025HLA050-03	04HY025HLA051-03	16	WH	1N						220VACN	04A550CB04		TSB		15.3.2004
	NULL	04HY025HLA050-04	04A809-TB POWER-04	16	BK	1N						220 VAC	04A550CB04		TSB		15.3.2004
	NULL	04HY025HLA050-CHASSIS	04W1H	16	WH							FRM GND			TSB		15.3.2004
	NULL	04HY025HLA051-01	04HY025HLA052-01	16	WH	1N						220VACN	04A550CB04		TSB		15.3.2004
	NULL	04HY025HLA051-03	04HY025HLA052-03	16	WH	1N						220VACN	04A550CB04		TSB		15.3.2004
	NULL	04HY025HLA051-04	04A809-TB POWER-06	16	BK	1N						220 VAC	04A550CB04		TSB		15.3.2004
	NULL	04HY025HLA051-CHASSIS	04W1H	16	WH							FRM GND			TSB		15.3.2004
	NULL	04HY025HLA052-01	04HY025HLA053-01	16	WH	1N						220VACN	04A550CB04		TSB		15.3.2004
	NULL	04HY025HLA052-03	04HY025HLA053-03	16	WH	1N						220VACN	04A550CB04		TSB		15.3.2004
	NULL	04HY025HLA052-04	04A809-TB POWER-08	16	BK	1N						220 VAC	04A550CB04		TSB		15.3.2004
	NULL	04HY025HLA052-CHASSIS	04W1H	16	WH							FRM GND			TSB		15.3.2004
	NULL	04HY025HLA053-01	04HY025HLA054-01	16	WH	1N						220VACN	04A550CB04		TSB		15.3.2004
	NULL	04HY025HLA053-03	04HY025HLA054-03	16	WH	1N						220VACN	04A550CB04		TSB		15.3.2004
	NULL	04HY025HLA053-04	04A809-TB POWER-10	16	BK	1N						220 VAC	04A550CB04		TSB		15.3.2004
	NULL	04HY025HLA053-CHASSIS	04W1H	16	WH							FRM GND			TSB		15.3.2004

coord	coord_	From	To	WC	CC	NC	IO	SC	Word	bit	remarks	power	origin	daisy_	ped	rev_le	write_date
	NULL	04HY025HLA054-01	04HY025HLA055-01	16	WH	1N						220VACN	04A550CB04		TSB		15.3.2004
	NULL	04HY025HLA054-03	04HY025HLA055-03	16	WH	1N						220VACN	04A550CB04		TSB		15.3.2004
	NULL	04HY025HLA054-04	04A809-TB POWER-12	16	BK	1N						220 VAC	04A550CB04		TSB		15.3.2004
	NULL	04HY025HLA054-CHASSIS	04W1H	16	WH							FRM GND			TSB		15.3.2004
	NULL	04HY025HLA055-01	04HY025HLA056-01	16	WH	1N						220VACN	04A550CB04		TSB		15.3.2004
	NULL	04HY025HLA055-03	04HY025HLA056-03	16	WH	1N						220VACN	04A550CB04		TSB		15.3.2004
	NULL	04HY025HLA055-04	04A809-TB POWER-14	16	BK	1N						220 VAC	04A550CB04		TSB		15.3.2004
	NULL	04HY025HLA055-CHASSIS	04W1H	16	WH							FRM GND			TSB		15.3.2004
	NULL	04HY025HLA056-01	04HY025HLA057-01	16	WH	1N						220VACN	04A550CB04		TSB		15.3.2004
	NULL	04HY025HLA056-03	04HY025HLA057-03	16	WH	1N						220VACN	04A550CB04		TSB		15.3.2004
	NULL	04HY025HLA056-04	04A809-TB POWER-16	16	BK	1N						220 VAC	04A550CB04		TSB		15.3.2004
	NULL	04HY025HLA056-CHASSIS	04W1H	16	WH							FRM GND			TSB		15.3.2004
	NULL	04HY025HLA057-01	04HY025HLA058-01	16	WH	1N						220VACN	04A550CB04		TSB		15.3.2004
	NULL	04HY025HLA057-03	04HY025HLA058-03	16	WH	1N						220VACN	04A550CB04		TSB		15.3.2004
	NULL	04HY025HLA057-04	04A809-TB POWER-18	16	BK	1N						220 VAC	04A550CB04		TSB		15.3.2004
	NULL	04HY025HLA057-CHASSIS	04W1H	16	WH							FRM GND			TSB		15.3.2004
	NULL	04HY025HLA058-01	04HY025HLA059-01	16	WH	1N						220VACN	04A550CB04		TSB		15.3.2004
	NULL	04HY025HLA058-03	04HY025HLA059-03	16	WH	1N						220VACN	04A550CB04		TSB		15.3.2004
	NULL	04HY025HLA058-04	04A809-TB POWER-20	16	BK	1N						220 VAC	04A550CB04		TSB		15.3.2004
	NULL	04HY025HLA058-CHASSIS	04W1H	16	WH							FRM GND			TSB		15.3.2004
	NULL	04HY025HLA059-01	04HY025HLA060-01	16	WH	1N						220VACN	04A550CB04		TSB		15.3.2004
	NULL	04HY025HLA059-03	04HY025HLA060-03	16	WH	1N						220VACN	04A550CB04		TSB		15.3.2004
	NULL	04HY025HLA059-04	04A809-TB POWER-22	16	BK	1N						220 VAC	04A550CB04		TSB		15.3.2004
	NULL	04HY025HLA059-CHASSIS	04W1H	16	WH							FRM GND			TSB		15.3.2004
	NULL	04HY025HLA060-01	04HY025HLA061-01	16	WH	1N						220VACN	04A550CB04		TSB		15.3.2004
	NULL	04HY025HLA060-03	04HY025HLA061-03	16	WH	1N						220VACN	04A550CB04		TSB		15.3.2004
	NULL	04HY025HLA060-04	04A809-TB POWER-24	16	BK	1N						220 VAC	04A550CB04		TSB		15.3.2004
	NULL	04HY025HLA060-CHASSIS	04W1H	16	WH							FRM GND			TSB		15.3.2004
	NULL	04HY025HLA061-01	04HY025HLA062-01	16	WH	1N						220VACN	04A550CB04		TSB		15.3.2004
	NULL	04HY025HLA061-03	04HY025HLA062-03	16	WH	1N						220VACN	04A550CB04		TSB		15.3.2004
	NULL	04HY025HLA061-04	04A809-TB POWER-26	16	BK	1N						220 VAC	04A550CB04		TSB		15.3.2004
	NULL	04HY025HLA061-CHASSIS	04W1H	16	WH							FRM GND			TSB		15.3.2004
	NULL	04HY025HLA062-01	04HY025HLA063-01	16	WH	1N						220VACN	04A550CB04		TSB		15.3.2004
	NULL	04HY025HLA062-03	04HY025HLA063-03	16	WH	1N						220VACN	04A550CB04		TSB		15.3.2004
	NULL	04HY025HLA062-04	04A809-TB POWER-28	16	BK	1N						220 VAC	04A550CB04		TSB		15.3.2004
	NULL	04HY025HLA062-CHASSIS	04W1H	16	WH							FRM GND			TSB		15.3.2004
	NULL	04HY025HLA063-04	04A809-TB POWER-30	16	BK	1N						220 VAC	04A550CB04		TSB		15.3.2004
	NULL	04HY025HLA063-CHASSIS	04W1H	16	WH							FRM GND			TSB		15.3.2004
	NULL	04A806-TB SIGNAL-02	04A530-A2P09-01	22	WH		LO	4	006	00	04HY025HLA001				TSB		15.3.2004
	NULL	04A806-TB SIGNAL-04	04A530-A2P09-02	22	WH		LO	4	006	01	04HY025HLA002				TSB		15.3.2004
	NULL	04A806-TB SIGNAL-06	04A530-A2P09-03	22	WH		LO	4	006	02	04HY025HLA003				TSB		15.3.2004
	NULL	04A806-TB SIGNAL-08	04A530-A2P09-04	22	WH		LO	4	006	03	04HY025HLA004				TSB		15.3.2004
	NULL	04A806-TB SIGNAL-10	04A530-A2P09-05	22	WH		LO	4	006	04	04HY025HLA005				TSB		15.3.2004
	NULL	04A806-TB SIGNAL-12	04A530-A2P09-06	22	WH		LO	4	006	05	04HY025HLA006				TSB		15.3.2004
	NULL	04A806-TB SIGNAL-14	04A530-A2P09-07	22	WH		LO	4	006	06	04HY025HLA007				TSB		15.3.2004
	NULL	04A806-TB SIGNAL-16	04A530-A2P09-08	22	WH		LO	4	006	07	04HY025HLA008				TSB		15.3.2004
	NULL	04A806-TB SIGNAL-18	04A530-A2P09-09	22	WH		LO	4	006	08	04HY025HLA009				TSB		15.3.2004
	NULL	04A806-TB SIGNAL-20	04A530-A2P09-10	22	WH		LO	4	006	09	04HY025HLA010				TSB		15.3.2004
	NULL	04A806-TB SIGNAL-22	04A530-A2P09-11	22	WH		LO	4	006	10	04HY025HLA011				TSB		15.3.2004
	NULL	04A806-TB SIGNAL-24	04A530-A2P09-12	22	WH		LO	4	006	11	04HY025HLA012				TSB		15.3.2004
	NULL	04A806-TB SIGNAL-26	04A530-A2P09-13	22	WH		LO	4	006	12	04HY025HLA013				TSB		15.3.2004
	NULL	04A806-TB SIGNAL-28	04A530-A2P09-14	22	WH		LO	4	006	13	04HY025HLA014				TSB		15.3.2004
	NULL	04A806-TB SIGNAL-30	04A530-A2P09-15	22	WH		LO	4	006	14	04HY025HLA015				TSB		15.3.2004
	NULL	04A806-TB SIGNAL-32	04A530-A2P09-16	22	WH		LO	4	006	15	04HY025HLA016				TSB		15.3.2004

coord	coord_	From	To	WC	CC	NC	IO	SC	Word	bit	remarks	power	origin	daisy_	ped	rev_le	write_date
	NULL	04A807-TB SIGNAL-02	04A530-A2P10-01	22	WH		LO	4	007	00	04HY025HLA017				TSB		15.3.2004
	NULL	04A807-TB SIGNAL-04	04A530-A2P10-02	22	WH		LO	4	007	01	04HY025HLA018				TSB		15.3.2004
	NULL	04A807-TB SIGNAL-06	04A530-A2P10-03	22	WH		LO	4	007	02	04HY025HLA019				TSB		15.3.2004
	NULL	04A807-TB SIGNAL-08	04A530-A2P10-04	22	WH		LO	4	007	03	04HY025HLA020				TSB		15.3.2004
	NULL	04A807-TB SIGNAL-10	04A530-A2P10-05	22	WH		LO	4	007	04	04HY025HLA021				TSB		15.3.2004
	NULL	04A807-TB SIGNAL-12	04A530-A2P10-06	22	WH		LO	4	007	05	04HY025HLA022				TSB		15.3.2004
	NULL	04A807-TB SIGNAL-14	04A530-A2P10-07	22	WH		LO	4	007	06	04HY025HLA023				TSB		15.3.2004
	NULL	04A807-TB SIGNAL-16	04A530-A2P10-08	22	WH		LO	4	007	07	04HY025HLA024				TSB		15.3.2004
	NULL	04A807-TB SIGNAL-18	04A530-A2P10-09	22	WH		LO	4	007	08	04HY025HLA025				TSB		15.3.2004
	NULL	04A807-TB SIGNAL-20	04A530-A2P10-10	22	WH		LO	4	007	09	04HY025HLA026				TSB		15.3.2004
	NULL	04A807-TB SIGNAL-22	04A530-A2P10-11	22	WH		LO	4	007	10	04HY025HLA027				TSB		15.3.2004
	NULL	04A807-TB SIGNAL-24	04A530-A2P10-12	22	WH		LO	4	007	11	04HY025HLA028				TSB		15.3.2004
	NULL	04A807-TB SIGNAL-26	04A530-A2P10-13	22	WH		LO	4	007	12	04HY025HLA029				TSB		15.3.2004
	NULL	04A807-TB SIGNAL-28	04A530-A2P10-14	22	WH		LO	4	007	13	04HY025HLA030				TSB		15.3.2004
	NULL	04A807-TB SIGNAL-30	04A530-A2P10-15	22	WH		LO	4	007	14	04HY025HLA031				TSB		15.3.2004
	NULL	04A807-TB SIGNAL-32	04A530-A2P10-16	22	WH		LO	4	007	15	04HY025HLA032				TSB		15.3.2004
	NULL	04A808-TB SIGNAL-02	04A530-A2P11-01	22	WH		LO	4	008	00	04HY025HLA033				TSB		15.3.2004
	NULL	04A808-TB SIGNAL-04	04A530-A2P11-02	22	WH		LO	4	008	01	04HY025HLA034				TSB		15.3.2004
	NULL	04A808-TB SIGNAL-06	04A530-A2P11-03	22	WH		LO	4	008	02	04HY025HLA035				TSB		15.3.2004
	NULL	04A808-TB SIGNAL-08	04A530-A2P11-04	22	WH		LO	4	008	03	04HY025HLA036				TSB		15.3.2004
	NULL	04A808-TB SIGNAL-10	04A530-A2P11-05	22	WH		LO	4	008	04	04HY025HLA037				TSB		15.3.2004
	NULL	04A808-TB SIGNAL-12	04A530-A2P11-06	22	WH		LO	4	008	05	04HY025HLA038				TSB		15.3.2004
	NULL	04A808-TB SIGNAL-14	04A530-A2P11-07	22	WH		LO	4	008	06	04HY025HLA039				TSB		15.3.2004
	NULL	04A808-TB SIGNAL-16	04A530-A2P11-08	22	WH		LO	4	008	07	04HY025HLA040				TSB		15.3.2004
	NULL	04A808-TB SIGNAL-18	04A530-A2P11-09	22	WH		LO	4	008	08	04HY025HLA041				TSB		15.3.2004
	NULL	04A808-TB SIGNAL-20	04A530-A2P11-10	22	WH		LO	4	008	09	04HY025HLA042				TSB		15.3.2004
	NULL	04A808-TB SIGNAL-22	04A530-A2P11-11	22	WH		LO	4	008	10	04HY025HLA043				TSB		15.3.2004
	NULL	04A808-TB SIGNAL-24	04A530-A2P11-12	22	WH		LO	4	008	11	04HY025HLA044				TSB		15.3.2004
	NULL	04A808-TB SIGNAL-26	04A530-A2P11-13	22	WH		LO	4	008	12	04HY025HLA045				TSB		15.3.2004
	NULL	04A808-TB SIGNAL-28	04A530-A2P11-14	22	WH		LO	4	008	13	04HY025HLA046				TSB		15.3.2004
	NULL	04A808-TB SIGNAL-30	04A530-A2P11-15	22	WH		LO	4	008	14	04HY025HLA047				TSB		15.3.2004
	NULL	04A808-TB SIGNAL-32	04A530-A2P11-16	22	WH		LO	4	008	15	04HY025HLA048				TSB		15.3.2004
	NULL	04A809-TB SIGNAL-02	04A530-A2P12-01	22	WH		LO	4	009	00	04HY025HLA049				TSB		15.3.2004
	NULL	04A809-TB SIGNAL-04	04A530-A2P12-02	22	WH		LO	4	009	01	04HY025HLA050				TSB		15.3.2004
	NULL	04A809-TB SIGNAL-06	04A530-A2P12-03	22	WH		LO	4	009	02	04HY025HLA051				TSB		15.3.2004
	NULL	04A809-TB SIGNAL-08	04A530-A2P12-04	22	WH		LO	4	009	03	04HY025HLA052				TSB		15.3.2004
	NULL	04A809-TB SIGNAL-10	04A530-A2P12-05	22	WH		LO	4	009	04	04HY025HLA053				TSB		15.3.2004
	NULL	04A809-TB SIGNAL-12	04A530-A2P12-06	22	WH		LO	4	009	05	04HY025HLA054				TSB		15.3.2004
	NULL	04A809-TB SIGNAL-14	04A530-A2P12-07	22	WH		LO	4	009	06	04HY025HLA055				TSB		15.3.2004
	NULL	04A809-TB SIGNAL-16	04A530-A2P12-08	22	WH		LO	4	009	07	04HY025HLA056				TSB		15.3.2004
	NULL	04A809-TB SIGNAL-18	04A530-A2P12-09	22	WH		LO	4	009	08	04HY025HLA057				TSB		15.3.2004
	NULL	04A809-TB SIGNAL-20	04A530-A2P12-10	22	WH		LO	4	009	09	04HY025HLA058				TSB		15.3.2004
	NULL	04A809-TB SIGNAL-22	04A530-A2P12-11	22	WH		LO	4	009	10	04HY025HLA059				TSB		15.3.2004
	NULL	04A809-TB SIGNAL-24	04A530-A2P12-12	22	WH		LO	4	009	11	04HY025HLA060				TSB		15.3.2004
	NULL	04A809-TB SIGNAL-26	04A530-A2P12-13	22	WH		LO	4	009	12	04HY025HLA061				TSB		15.3.2004
	NULL	04A809-TB SIGNAL-28	04A530-A2P12-14	22	WH		LO	4	009	13	04HY025HLA062				TSB		15.3.2004
	NULL	04A809-TB SIGNAL-30	04A530-A2P12-15	22	WH		LO	4	009	14	04HY025HLA063				TSB		15.3.2004
HY26																	
	NULL	05HY026HLA001-01	05A680-K10-NC	16	WH	1N						220VACN	05A550CB03		TSB	A	15.3.2004
	NULL	05HY026HLA001-01	05HY026HLA002-01	16	WH	1N						220VACN	05A550CB03		TSB		15.3.2004
	NULL	05HY026HLA001-03	05A680-K07-NC	16	WH	1N						220VACN	05A550CB03		TSB	A	15.3.2004
	NULL	05HY026HLA001-03	05HY026HLA002-03	16	WH	1N						220VACN	05A550CB03		TSB		15.3.2004
	NULL	05HY026HLA001-04	05A800-TB POWER-02	16	BK	1N						220 VAC	05A550CB03		TSB		15.3.2004
	NULL	05HY026HLA001-CHASSIS	05W1B	16	WH							FRM GND			TSB		15.3.2004

coord	coord_	From	To	WC	CC	NC	IO	SC	Word	bit	remarks	power	origin	daisy_	ped	rev_le	write_date
	NULL	05HY026HLA002-01	05HY026HLA003-01	16	WH	1N						220VACN	05A550CB03		TSB		15.3.2004
	NULL	05HY026HLA002-03	05HY026HLA003-03	16	WH	1N						220VACN	05A550CB03		TSB		15.3.2004
	NULL	05HY026HLA002-04	05A800-TB POWER-04	16	BK	1N						220 VAC	05A550CB03		TSB		15.3.2004
	NULL	05HY026HLA002-CHASSIS	05W1B	16	WH							FRM GND			TSB		15.3.2004
	NULL	05HY026HLA003-01	05HY026HLA004-01	16	WH	1N						220VACN	05A550CB03		TSB		15.3.2004
	NULL	05HY026HLA003-03	05HY026HLA004-03	16	WH	1N						220VACN	05A550CB03		TSB		15.3.2004
	NULL	05HY026HLA003-04	05A800-TB POWER-06	16	BK	1N						220 VAC	05A550CB03		TSB		15.3.2004
	NULL	05HY026HLA003-CHASSIS	05W1B	16	WH							FRM GND			TSB		15.3.2004
	NULL	05HY026HLA004-01	05HY026HLA005-01	16	WH	1N						220VACN	05A550CB03		TSB		15.3.2004
	NULL	05HY026HLA004-03	05HY026HLA005-03	16	WH	1N						220VACN	05A550CB03		TSB		15.3.2004
	NULL	05HY026HLA004-04	05A800-TB POWER-08	16	BK	1N						220 VAC	05A550CB03		TSB		15.3.2004
	NULL	05HY026HLA004-CHASSIS	05W1B	16	WH							FRM GND			TSB		15.3.2004
	NULL	05HY026HLA005-01	05HY026HLA006-01	16	WH	1N						220VACN	05A550CB03		TSB		15.3.2004
	NULL	05HY026HLA005-03	05HY026HLA006-03	16	WH	1N						220VACN	05A550CB03		TSB		15.3.2004
	NULL	05HY026HLA005-04	05A800-TB POWER-10	16	BK	1N						220 VAC	05A550CB03		TSB		15.3.2004
	NULL	05HY026HLA005-CHASSIS	05W1B	16	WH							FRM GND			TSB		15.3.2004
	NULL	05HY026HLA006-01	05HY026HLA007-01	16	WH	1N						220VACN	05A550CB03		TSB		15.3.2004
	NULL	05HY026HLA006-03	05HY026HLA007-03	16	WH	1N						220VACN	05A550CB03		TSB		15.3.2004
	NULL	05HY026HLA006-04	05A800-TB POWER-12	16	BK	1N						220 VAC	05A550CB03		TSB		15.3.2004
	NULL	05HY026HLA006-CHASSIS	05W1B	16	WH							FRM GND			TSB		15.3.2004
	NULL	05HY026HLA007-01	05HY026HLA014-01	16	WH	1N						220VACN	05A550CB03		TSB		15.3.2004
	NULL	05HY026HLA007-03	05HY026HLA014-03	16	WH	1N						220VACN	05A550CB03		TSB		15.3.2004
	NULL	05HY026HLA007-04	05A800-TB POWER-14	16	BK	1N						220 VAC	05A550CB03		TSB		15.3.2004
	NULL	05HY026HLA007-CHASSIS	05W1B	16	WH							FRM GND			TSB		15.3.2004
	NULL	05HY026HLA008-01	05HY026HLA015-01	16	WH	1N						220VACN	05A550CB03		TSB		15.3.2004
	NULL	05HY026HLA008-03	05HY026HLA015-03	16	WH	1N						220VACN	05A550CB03		TSB		15.3.2004
	NULL	05HY026HLA008-04	05A800-TB POWER-16	16	BK	1N						220 VAC	05A550CB03		TSB		15.3.2004
	NULL	05HY026HLA008-CHASSIS	05W1B	16	WH							FRM GND			TSB		15.3.2004
	NULL	05HY026HLA009-01	05HY026HLA008-01	16	WH	1N						220VACN	05A550CB03		TSB		15.3.2004
	NULL	05HY026HLA009-03	05HY026HLA008-03	16	WH	1N						220VACN	05A550CB03		TSB		15.3.2004
	NULL	05HY026HLA009-04	05A800-TB POWER-18	16	BK	1N						220 VAC	05A550CB03		TSB		15.3.2004
	NULL	05HY026HLA009-CHASSIS	05W1B	16	WH							FRM GND			TSB		15.3.2004
	NULL	05HY026HLA010-01	05HY026HLA009-01	16	WH	1N						220VACN	05A550CB03		TSB		15.3.2004
	NULL	05HY026HLA010-03	05HY026HLA009-03	16	WH	1N						220VACN	05A550CB03		TSB		15.3.2004
	NULL	05HY026HLA010-04	05A800-TB POWER-20	16	BK	1N						220 VAC	05A550CB03		TSB		15.3.2004
	NULL	05HY026HLA010-CHASSIS	05W1B	16	WH							FRM GND			TSB		15.3.2004
	NULL	05HY026HLA011-01	05HY026HLA010-01	16	WH	1N						220VACN	05A550CB03		TSB		15.3.2004
	NULL	05HY026HLA011-03	05HY026HLA010-03	16	WH	1N						220VACN	05A550CB03		TSB		15.3.2004
	NULL	05HY026HLA011-04	05A800-TB POWER-22	16	BK	1N						220 VAC	05A550CB03		TSB		15.3.2004
	NULL	05HY026HLA011-CHASSIS	05W1B	16	WH							FRM GND			TSB		15.3.2004
	NULL	05HY026HLA012-01	05HY026HLA011-01	16	WH	1N						220VACN	05A550CB03		TSB		15.3.2004
	NULL	05HY026HLA012-03	05HY026HLA011-03	16	WH	1N						220VACN	05A550CB03		TSB		15.3.2004
	NULL	05HY026HLA012-04	05A800-TB POWER-24	16	BK	1N						220 VAC	05A550CB03		TSB		15.3.2004
	NULL	05HY026HLA012-CHASSIS	05W1B	16	WH							FRM GND			TSB		15.3.2004
	NULL	05HY026HLA013-01	05HY026HLA012-01	16	WH	1N						220VACN	05A550CB03		TSB		15.3.2004
	NULL	05HY026HLA013-03	05HY026HLA012-03	16	WH	1N						220VACN	05A550CB03		TSB		15.3.2004
	NULL	05HY026HLA013-04	05A800-TB POWER-26	16	BK	1N						220 VAC	05A550CB03		TSB		15.3.2004
	NULL	05HY026HLA013-CHASSIS	05W1B	16	WH							FRM GND			TSB		15.3.2004
	NULL	05HY026HLA014-01	05HY026HLA013-01	16	WH	1N						220VACN	05A550CB03		TSB		15.3.2004
	NULL	05HY026HLA014-03	05HY026HLA013-03	16	WH	1N						220VACN	05A550CB03		TSB		15.3.2004
	NULL	05HY026HLA014-04	05A800-TB POWER-28	16	BK	1N						220 VAC	05A550CB03		TSB		15.3.2004
	NULL	05HY026HLA014-CHASSIS	05W1B	16	WH							FRM GND			TSB		15.3.2004
	NULL	05HY026HLA015-01	05HY026HLA016-01	16	WH	1N						220VACN	05A550CB03		TSB		15.3.2004
	NULL	05HY026HLA015-03	05HY026HLA016-03	16	WH	1N						220VACN	05A550CB03		TSB		15.3.2004

coord	coord_	From	To	WC	CC	NC	IO	SC	Word	bit	remarks	power	origin	daisy_	ped	rev_le	write_date
	NULL	05HY026HLA015-04	05A800-TB POWER-30	16	BK	1N						220 VAC	05A550CB03		TSB		15.3.2004
	NULL	05HY026HLA015-CHASSIS	05W1B	16	WH							FRM GND			TSB		15.3.2004
	NULL	05HY026HLA016-01	05HY026HLA017-01	16	WH	1N						220VACN	05A550CB03		TSB		15.3.2004
	NULL	05HY026HLA016-03	05HY026HLA017-03	16	WH	1N						220VACN	05A550CB03		TSB		15.3.2004
	NULL	05HY026HLA016-04	05A800-TB POWER-32	16	BK	1N						220 VAC	05A550CB03		TSB		15.3.2004
	NULL	05HY026HLA016-CHASSIS	05W1B	16	WH							FRM GND			TSB		15.3.2004
	NULL	05HY026HLA017-01	05HY026HLA018-01	16	WH	1N						220VACN	05A550CB03		TSB		15.3.2004
	NULL	05HY026HLA017-03	05HY026HLA018-03	16	WH	1N						220VACN	05A550CB03		TSB		15.3.2004
	NULL	05HY026HLA017-04	05A801-TB POWER-02	16	BK	1N						220 VAC	05A550CB03		TSB		15.3.2004
	NULL	05HY026HLA017-CHASSIS	05W1B	16	WH							FRM GND			TSB		15.3.2004
	NULL	05HY026HLA018-01	05HY026HLA019-01	16	WH	1N						220VACN	05A550CB03		TSB		15.3.2004
	NULL	05HY026HLA018-03	05HY026HLA019-03	16	WH	1N						220VACN	05A550CB03		TSB		15.3.2004
	NULL	05HY026HLA018-04	05A801-TB POWER-04	16	BK	1N						220 VAC	05A550CB03		TSB		15.3.2004
	NULL	05HY026HLA018-CHASSIS	05W1B	16	WH							FRM GND			TSB		15.3.2004
	NULL	05HY026HLA019-01	05HY026HLA020-01	16	WH	1N						220VACN	05A550CB03		TSB		15.3.2004
	NULL	05HY026HLA019-03	05HY026HLA020-03	16	WH	1N						220VACN	05A550CB03		TSB		15.3.2004
	NULL	05HY026HLA019-04	05A801-TB POWER-06	16	BK	1N						220 VAC	05A550CB03		TSB		15.3.2004
	NULL	05HY026HLA019-CHASSIS	05W1B	16	WH							FRM GND			TSB		15.3.2004
	NULL	05HY026HLA020-01	05HY026HLA021-01	16	WH	1N						220VACN	05A550CB03		TSB		15.3.2004
	NULL	05HY026HLA020-03	05HY026HLA021-03	16	WH	1N						220VACN	05A550CB03		TSB		15.3.2004
	NULL	05HY026HLA020-04	05A801-TB POWER-08	16	BK	1N						220 VAC	05A550CB03		TSB		15.3.2004
	NULL	05HY026HLA020-CHASSIS	05W1B	16	WH							FRM GND			TSB		15.3.2004
	NULL	05HY026HLA021-01	05HY026HLA030-01	16	WH	1N						220VACN	05A550CB03		TSB		15.3.2004
	NULL	05HY026HLA021-03	05HY026HLA030-03	16	WH	1N						220VACN	05A550CB03		TSB		15.3.2004
	NULL	05HY026HLA021-04	05A801-TB POWER-10	16	BK	1N						220 VAC	05A550CB03		TSB		15.3.2004
	NULL	05HY026HLA021-CHASSIS	05W1B	16	WH							FRM GND			TSB		15.3.2004
	NULL	05HY026HLA022-01	05HY026HLA031-01	16	WH	1N						220VACN	05A550CB03		TSB		15.3.2004
	NULL	05HY026HLA022-03	05HY026HLA031-03	16	WH	1N						220VACN	05A550CB03		TSB		15.3.2004
	NULL	05HY026HLA022-04	05A801-TB POWER-12	16	BK	1N						220 VAC	05A550CB03		TSB		15.3.2004
	NULL	05HY026HLA022-CHASSIS	05W1C	16	WH							FRM GND			TSB		15.3.2004
	NULL	05HY026HLA023-01	05HY026HLA022-01	16	WH	1N						220VACN	05A550CB03		TSB		15.3.2004
	NULL	05HY026HLA023-03	05HY026HLA022-03	16	WH	1N						220VACN	05A550CB03		TSB		15.3.2004
	NULL	05HY026HLA023-04	05A801-TB POWER-14	16	BK	1N						220 VAC	05A550CB03		TSB		15.3.2004
	NULL	05HY026HLA023-CHASSIS	05W1C	16	WH							FRM GND			TSB		15.3.2004
	NULL	05HY026HLA024-01	05HY026HLA023-01	16	WH	1N						220VACN	05A550CB03		TSB		15.3.2004
	NULL	05HY026HLA024-03	05HY026HLA023-03	16	WH	1N						220VACN	05A550CB03		TSB		15.3.2004
	NULL	05HY026HLA024-04	05A801-TB POWER-16	16	BK	1N						220 VAC	05A550CB03		TSB		15.3.2004
	NULL	05HY026HLA024-CHASSIS	05W1C	16	WH							FRM GND			TSB		15.3.2004
	NULL	05HY026HLA025-01	05HY026HLA024-01	16	WH	1N						220VACN	05A550CB03		TSB		15.3.2004
	NULL	05HY026HLA025-03	05HY026HLA024-03	16	WH	1N						220VACN	05A550CB03		TSB		15.3.2004
	NULL	05HY026HLA025-04	05A801-TB POWER-18	16	BK	1N						220 VAC	05A550CB03		TSB		15.3.2004
	NULL	05HY026HLA025-CHASSIS	05W1C	16	WH							FRM GND			TSB		15.3.2004
	NULL	05HY026HLA026-01	05HY026HLA025-01	16	WH	1N						220VACN	05A550CB03		TSB		15.3.2004
	NULL	05HY026HLA026-03	05HY026HLA025-03	16	WH	1N						220VACN	05A550CB03		TSB		15.3.2004
	NULL	05HY026HLA026-04	05A801-TB POWER-20	16	BK	1N						220 VAC	05A550CB03		TSB		15.3.2004
	NULL	05HY026HLA026-CHASSIS	05W1C	16	WH							FRM GND			TSB		15.3.2004
	NULL	05HY026HLA027-01	05HY026HLA026-01	16	WH	1N						220VACN	05A550CB03		TSB		15.3.2004
	NULL	05HY026HLA027-03	05HY026HLA026-03	16	WH	1N						220VACN	05A550CB03		TSB		15.3.2004
	NULL	05HY026HLA027-04	05A801-TB POWER-22	16	BK	1N						220 VAC	05A550CB03		TSB		15.3.2004
	NULL	05HY026HLA027-CHASSIS	05W1C	16	WH							FRM GND			TSB		15.3.2004
	NULL	05HY026HLA028-01	05HY026HLA027-01	16	WH	1N						220VACN	05A550CB03		TSB		15.3.2004
	NULL	05HY026HLA028-03	05HY026HLA027-03	16	WH	1N						220VACN	05A550CB03		TSB		15.3.2004
	NULL	05HY026HLA028-04	05A801-TB POWER-24	16	BK	1N						220 VAC	05A550CB03		TSB		15.3.2004
	NULL	05HY026HLA028-CHASSIS	05W1C	16	WH							FRM GND			TSB		15.3.2004

coord	coord_	From	To	WC	CC	NC	IO	SC	Word	bit	remarks	power	origin	daisy_	ped	rev_le	write_date
	NULL	05HY026HLA029-01	05HY026HLA028-01	16	WH	1N						220VACN	05A550CB03		TSB		15.3.2004
	NULL	05HY026HLA029-03	05HY026HLA028-03	16	WH	1N						220VACN	05A550CB03		TSB		15.3.2004
	NULL	05HY026HLA029-04	05A801-TB POWER-26	16	BK	1N						220 VAC	05A550CB03		TSB		15.3.2004
	NULL	05HY026HLA029-CHASSIS	05W1C	16	WH							FRM GND			TSB		15.3.2004
	NULL	05HY026HLA030-01	05HY026HLA029-01	16	WH	1N						220VACN	05A550CB03		TSB		15.3.2004
	NULL	05HY026HLA030-03	05HY026HLA029-03	16	WH	1N						220VACN	05A550CB03		TSB		15.3.2004
	NULL	05HY026HLA030-04	05A801-TB POWER-28	16	BK	1N						220 VAC	05A550CB03		TSB		15.3.2004
	NULL	05HY026HLA030-CHASSIS	05W1C	16	WH							FRM GND			TSB		15.3.2004
	NULL	05HY026HLA031-01	05HY026HLA032-01	16	WH	1N						220VACN	05A550CB03		TSB		15.3.2004
	NULL	05HY026HLA031-03	05HY026HLA032-03	16	WH	1N						220VACN	05A550CB03		TSB		15.3.2004
	NULL	05HY026HLA031-04	05A801-TB POWER-30	16	BK	1N						220 VAC	05A550CB03		TSB		15.3.2004
	NULL	05HY026HLA031-CHASSIS	05W1C	16	WH							FRM GND			TSB		15.3.2004
	NULL	05HY026HLA032-01	05HY026HLA033-01	16	WH	1N						220VACN	05A550CB03		TSB		15.3.2004
	NULL	05HY026HLA032-03	05HY026HLA033-03	16	WH	1N						220VACN	05A550CB03		TSB		15.3.2004
	NULL	05HY026HLA032-04	05A801-TB POWER-32	16	BK	1N						220 VAC	05A550CB03		TSB		15.3.2004
	NULL	05HY026HLA032-CHASSIS	05W1C	16	WH							FRM GND			TSB		15.3.2004
	NULL	05HY026HLA033-01	05HY026HLA034-01	16	WH	1N						220VACN	05A550CB03		TSB		15.3.2004
	NULL	05HY026HLA033-03	05HY026HLA034-03	16	WH	1N						220VACN	05A550CB03		TSB		15.3.2004
	NULL	05HY026HLA033-04	05A802-TB POWER-02	16	BK	1N						220 VAC	05A550CB03		TSB		15.3.2004
	NULL	05HY026HLA033-CHASSIS	05W1C	16	WH							FRM GND			TSB		15.3.2004
	NULL	05HY026HLA034-01	05HY026HLA035-01	16	WH	1N						220VACN	05A550CB03		TSB		15.3.2004
	NULL	05HY026HLA034-03	05HY026HLA035-03	16	WH	1N						220VACN	05A550CB03		TSB		15.3.2004
	NULL	05HY026HLA034-04	05A802-TB POWER-04	16	BK	1N						220 VAC	05A550CB03		TSB		15.3.2004
	NULL	05HY026HLA034-CHASSIS	05W1C	16	WH							FRM GND			TSB		15.3.2004
	NULL	05HY026HLA035-01	05HY026HLA036-01	16	WH	1N						220VACN	05A550CB03		TSB		15.3.2004
	NULL	05HY026HLA035-03	05HY026HLA036-03	16	WH	1N						220VACN	05A550CB03		TSB		15.3.2004
	NULL	05HY026HLA035-04	05A802-TB POWER-06	16	BK	1N						220 VAC	05A550CB03		TSB		15.3.2004
	NULL	05HY026HLA035-CHASSIS	05W1C	16	WH							FRM GND			TSB		15.3.2004
	NULL	05HY026HLA036-01	05HY026HLA037-01	16	WH	1N						220VACN	05A550CB03		TSB		15.3.2004
	NULL	05HY026HLA036-03	05HY026HLA037-03	16	WH	1N						220VACN	05A550CB03		TSB		15.3.2004
	NULL	05HY026HLA036-04	05A802-TB POWER-08	16	BK	1N						220 VAC	05A550CB03		TSB		15.3.2004
	NULL	05HY026HLA036-CHASSIS	05W1C	16	WH							FRM GND			TSB		15.3.2004
	NULL	05HY026HLA037-01	05HY026HLA038-01	16	WH	1N						220VACN	05A550CB03		TSB		15.3.2004
	NULL	05HY026HLA037-03	05HY026HLA038-03	16	WH	1N						220VACN	05A550CB03		TSB		15.3.2004
	NULL	05HY026HLA037-04	05A802-TB POWER-10	16	BK	1N						220 VAC	05A550CB03		TSB		15.3.2004
	NULL	05HY026HLA037-CHASSIS	05W1C	16	WH							FRM GND			TSB		15.3.2004
	NULL	05HY026HLA038-01	05HY026HLA039-01	16	WH	1N						220VACN	05A550CB03		TSB		15.3.2004
	NULL	05HY026HLA038-03	05HY026HLA039-03	16	WH	1N						220VACN	05A550CB03		TSB		15.3.2004
	NULL	05HY026HLA038-04	05A802-TB POWER-12	16	BK	1N						220 VAC	05A550CB03		TSB		15.3.2004
	NULL	05HY026HLA038-CHASSIS	05W1C	16	WH							FRM GND			TSB		15.3.2004
	NULL	05HY026HLA039-04	05A802-TB POWER-14	16	BK	1N						220 VAC	05A550CB03		TSB		15.3.2004
	NULL	05HY026HLA039-CHASSIS	05W1C	16	WH							FRM GND			TSB		15.3.2004
	NULL	05A800-TB SIGNAL-02	05A530-A2P08-01	22	WH		LO	1	069	00	05HY026HLA001				TSB		15.3.2004
	NULL	05A800-TB SIGNAL-04	05A530-A2P08-02	22	WH		LO	1	069	01	05HY026HLA002				TSB		15.3.2004
	NULL	05A800-TB SIGNAL-06	05A530-A2P08-03	22	WH		LO	1	069	02	05HY026HLA003				TSB		15.3.2004
	NULL	05A800-TB SIGNAL-08	05A530-A2P08-04	22	WH		LO	1	069	03	05HY026HLA004				TSB		15.3.2004
	NULL	05A800-TB SIGNAL-10	05A530-A2P08-05	22	WH		LO	1	069	04	05HY026HLA005				TSB		15.3.2004
	NULL	05A800-TB SIGNAL-12	05A530-A2P08-06	22	WH		LO	1	069	05	05HY026HLA006				TSB		15.3.2004
	NULL	05A800-TB SIGNAL-14	05A530-A2P08-07	22	WH		LO	1	069	06	05HY026HLA007				TSB		15.3.2004
	NULL	05A800-TB SIGNAL-16	05A530-A2P08-08	22	WH		LO	1	069	07	05HY026HLA008				TSB		15.3.2004
	NULL	05A800-TB SIGNAL-18	05A530-A2P08-09	22	WH		LO	1	069	08	05HY026HLA009				TSB		15.3.2004
	NULL	05A800-TB SIGNAL-20	05A530-A2P08-10	22	WH		LO	1	069	09	05HY026HLA010				TSB		15.3.2004
	NULL	05A800-TB SIGNAL-22	05A530-A2P08-11	22	WH		LO	1	069	10	05HY026HLA011				TSB		15.3.2004
	NULL	05A800-TB SIGNAL-24	05A530-A2P08-12	22	WH		LO	1	069	11	05HY026HLA012				TSB		15.3.2004

coord	coord_	From	To	WC	CC	NC	IO	SC	Word	bit	remarks	power	origin	daisy_	ped	rev_le	write_date
	NULL	05A800-TB SIGNAL-26	05A530-A2P08-13	22	WH		LO	1	069	12	05HY026HLA013				TSB		15.3.2004
	NULL	05A800-TB SIGNAL-28	05A530-A2P08-14	22	WH		LO	1	069	13	05HY026HLA014				TSB		15.3.2004
	NULL	05A800-TB SIGNAL-30	05A530-A2P08-15	22	WH		LO	1	069	14	05HY026HLA015				TSB		15.3.2004
	NULL	05A800-TB SIGNAL-32	05A530-A2P08-16	22	WH		LO	1	069	15	05HY026HLA016				TSB		15.3.2004
	NULL	05A801-TB SIGNAL-02	05A530-A2P09-01	22	WH		LO	1	070	00	05HY026HLA017				TSB		15.3.2004
	NULL	05A801-TB SIGNAL-04	05A530-A2P09-02	22	WH		LO	1	070	01	05HY026HLA018				TSB		15.3.2004
	NULL	05A801-TB SIGNAL-06	05A530-A2P09-03	22	WH		LO	1	070	02	05HY026HLA019				TSB		15.3.2004
	NULL	05A801-TB SIGNAL-08	05A530-A2P09-04	22	WH		LO	1	070	03	05HY026HLA020				TSB		15.3.2004
	NULL	05A801-TB SIGNAL-10	05A530-A2P09-05	22	WH		LO	1	070	04	05HY026HLA021				TSB		15.3.2004
	NULL	05A801-TB SIGNAL-12	05A530-A2P09-06	22	WH		LO	1	070	05	05HY026HLA022				TSB		15.3.2004
	NULL	05A801-TB SIGNAL-14	05A530-A2P09-07	22	WH		LO	1	070	06	05HY026HLA023				TSB		15.3.2004
	NULL	05A801-TB SIGNAL-16	05A530-A2P09-08	22	WH		LO	1	070	07	05HY026HLA024				TSB		15.3.2004
	NULL	05A801-TB SIGNAL-18	05A530-A2P09-09	22	WH		LO	1	070	08	05HY026HLA025				TSB		15.3.2004
	NULL	05A801-TB SIGNAL-20	05A530-A2P09-10	22	WH		LO	1	070	09	05HY026HLA026				TSB		15.3.2004
	NULL	05A801-TB SIGNAL-22	05A530-A2P09-11	22	WH		LO	1	070	10	05HY026HLA027				TSB		15.3.2004
	NULL	05A801-TB SIGNAL-24	05A530-A2P09-12	22	WH		LO	1	070	11	05HY026HLA028				TSB		15.3.2004
	NULL	05A801-TB SIGNAL-26	05A530-A2P09-13	22	WH		LO	1	070	12	05HY026HLA029				TSB		15.3.2004
	NULL	05A801-TB SIGNAL-28	05A530-A2P09-14	22	WH		LO	1	070	13	05HY026HLA030				TSB		15.3.2004
	NULL	05A801-TB SIGNAL-30	05A530-A2P09-15	22	WH		LO	1	070	14	05HY026HLA031				TSB		15.3.2004
	NULL	05A801-TB SIGNAL-32	05A530-A2P09-16	22	WH		LO	1	070	15	05HY026HLA032				TSB		15.3.2004
	NULL	05A802-TB SIGNAL-02	05A530-A2P10-01	22	WH		LO	1	071	00	05HY026HLA033				TSB		15.3.2004
	NULL	05A802-TB SIGNAL-04	05A530-A2P10-02	22	WH		LO	1	071	01	05HY026HLA034				TSB		15.3.2004
	NULL	05A802-TB SIGNAL-06	05A530-A2P10-03	22	WH		LO	1	071	02	05HY026HLA035				TSB		15.3.2004
	NULL	05A802-TB SIGNAL-08	05A530-A2P10-04	22	WH		LO	1	071	03	05HY026HLA036				TSB		15.3.2004
	NULL	05A802-TB SIGNAL-10	05A530-A2P10-05	22	WH		LO	1	071	04	05HY026HLA037				TSB		15.3.2004
	NULL	05A802-TB SIGNAL-12	05A530-A2P10-06	22	WH		LO	1	071	05	05HY026HLA038				TSB		15.3.2004
	NULL	05A802-TB SIGNAL-14	05A530-A2P10-07	22	WH		LO	1	071	06	05HY026HLA039				TSB		15.3.2004
HY27																	
	NULL	05HY027HLA001-01	05A681-K02-05	16	WH	1N						220VACN	05A550CB03		TSB		15.3.2004
	NULL	05HY027HLA001-01	05HY027HLA002-01	16	WH	1N						220VACN	05A550CB03		TSB		15.3.2004
	NULL	05HY027HLA001-03	05A681-K01-05	16	WH	1N						220VACN	05A550CB03		TSB		15.3.2004
	NULL	05HY027HLA001-03	05HY027HLA002-03	16	WH	1N						220VACN	05A550CB03		TSB		15.3.2004
	NULL	05HY027HLA001-04	05A802-TB POWER-16	16	BK	1N						220 VAC	05A550CB03		TSB		15.3.2004
	NULL	05HY027HLA001-CHASSIS	05W1D	16	WH							FRM GND			TSB		15.3.2004
	NULL	05HY027HLA002-01	05HY027HLA003-01	16	WH	1N						220VACN	05A550CB03		TSB		15.3.2004
	NULL	05HY027HLA002-03	05HY027HLA003-03	16	WH	1N						220VACN	05A550CB03		TSB		15.3.2004
	NULL	05HY027HLA002-04	05A802-TB POWER-18	16	BK	1N						220 VAC	05A550CB03		TSB		15.3.2004
	NULL	05HY027HLA002-CHASSIS	05W1D	16	WH							FRM GND			TSB		15.3.2004
	NULL	05HY027HLA003-01	05HY027HLA004-01	16	WH	1N						220VACN	05A550CB03		TSB		15.3.2004
	NULL	05HY027HLA003-03	05HY027HLA004-03	16	WH	1N						220VACN	05A550CB03		TSB		15.3.2004
	NULL	05HY027HLA003-04	05A802-TB POWER-20	16	BK	1N						220 VAC	05A550CB03		TSB		15.3.2004
	NULL	05HY027HLA003-CHASSIS	05W1D	16	WH							FRM GND			TSB		15.3.2004
	NULL	05HY027HLA004-01	05HY027HLA005-01	16	WH	1N						220VACN	05A550CB03		TSB		15.3.2004
	NULL	05HY027HLA004-03	05HY027HLA005-03	16	WH	1N						220VACN	05A550CB03		TSB		15.3.2004
	NULL	05HY027HLA004-04	05A802-TB POWER-22	16	BK	1N						220 VAC	05A550CB03		TSB		15.3.2004
	NULL	05HY027HLA004-CHASSIS	05W1D	16	WH							FRM GND			TSB		15.3.2004
	NULL	05HY027HLA005-01	05HY027HLA006-01	16	WH	1N						220VACN	05A550CB03		TSB		15.3.2004
	NULL	05HY027HLA005-03	05HY027HLA006-03	16	WH	1N						220VACN	05A550CB03		TSB		15.3.2004
	NULL	05HY027HLA005-04	05A802-TB POWER-24	16	BK	1N						220 VAC	05A550CB03		TSB		15.3.2004
	NULL	05HY027HLA005-CHASSIS	05W1D	16	WH							FRM GND			TSB		15.3.2004
	NULL	05HY027HLA006-01	05HY027HLA007-01	16	WH	1N						220VACN	05A550CB03		TSB		15.3.2004
	NULL	05HY027HLA006-03	05HY027HLA007-03	16	WH	1N						220VACN	05A550CB03		TSB		15.3.2004
	NULL	05HY027HLA006-04	05A802-TB POWER-26	16	BK	1N						220 VAC	05A550CB03		TSB		15.3.2004
	NULL	05HY027HLA006-CHASSIS	05W1D	16	WH							FRM GND			TSB		15.3.2004

coord	coord_	From	To	WC	CC	NC	IO	SC	Word	bit	remarks	power	origin	daisy_	ped	rev_le	write_date
	NULL	05HY027HLA007-01	05HY027HLA014-01	16	WH	1N						220VACN	05A550CB03		TSB		15.3.2004
	NULL	05HY027HLA007-03	05HY027HLA014-03	16	WH	1N						220VACN	05A550CB03		TSB		15.3.2004
	NULL	05HY027HLA007-04	05A802-TB POWER-28	16	BK	1N						220 VAC	05A550CB03		TSB		15.3.2004
	NULL	05HY027HLA007-CHASSIS	05W1D	16	WH							FRM GND			TSB		15.3.2004
	NULL	05HY027HLA008-01	05HY027HLA015-01	16	WH	1N						220VACN	05A550CB03		TSB		15.3.2004
	NULL	05HY027HLA008-03	05HY027HLA015-03	16	WH	1N						220VACN	05A550CB03		TSB		15.3.2004
	NULL	05HY027HLA008-04	05A802-TB POWER-30	16	BK	1N						220 VAC	05A550CB03		TSB		15.3.2004
	NULL	05HY027HLA008-CHASSIS	05W1D	16	WH							FRM GND			TSB		15.3.2004
	NULL	05HY027HLA009-01	05HY027HLA008-01	16	WH	1N						220VACN	05A550CB03		TSB		15.3.2004
	NULL	05HY027HLA009-03	05HY027HLA008-03	16	WH	1N						220VACN	05A550CB03		TSB		15.3.2004
	NULL	05HY027HLA009-04	05A802-TB POWER-32	16	BK	1N						220 VAC	05A550CB03		TSB		15.3.2004
	NULL	05HY027HLA009-CHASSIS	05W1D	16	WH							FRM GND			TSB		15.3.2004
	NULL	05HY027HLA010-01	05HY027HLA009-01	16	WH	1N						220VACN	05A550CB03		TSB		15.3.2004
	NULL	05HY027HLA010-03	05HY027HLA009-03	16	WH	1N						220VACN	05A550CB03		TSB		15.3.2004
	NULL	05HY027HLA010-04	05A803-TB POWER-02	16	BK	1N						220 VAC	05A550CB03		TSB		15.3.2004
	NULL	05HY027HLA010-CHASSIS	05W1D	16	WH							FRM GND			TSB		15.3.2004
	NULL	05HY027HLA011-01	05HY027HLA010-01	16	WH	1N						220VACN	05A550CB03		TSB		15.3.2004
	NULL	05HY027HLA011-03	05HY027HLA010-03	16	WH	1N						220VACN	05A550CB03		TSB		15.3.2004
	NULL	05HY027HLA011-04	05A803-TB POWER-04	16	BK	1N						220 VAC	05A550CB03		TSB		15.3.2004
	NULL	05HY027HLA011-CHASSIS	05W1D	16	WH							FRM GND			TSB		15.3.2004
	NULL	05HY027HLA012-01	05HY027HLA011-01	16	WH	1N						220VACN	05A550CB03		TSB		15.3.2004
	NULL	05HY027HLA012-03	05HY027HLA011-03	16	WH	1N						220VACN	05A550CB03		TSB		15.3.2004
	NULL	05HY027HLA012-04	05A803-TB POWER-06	16	BK	1N						220 VAC	05A550CB03		TSB		15.3.2004
	NULL	05HY027HLA012-CHASSIS	05W1D	16	WH							FRM GND			TSB		15.3.2004
	NULL	05HY027HLA013-01	05HY027HLA012-01	16	WH	1N						220VACN	05A550CB03		TSB		15.3.2004
	NULL	05HY027HLA013-03	05HY027HLA012-03	16	WH	1N						220VACN	05A550CB03		TSB		15.3.2004
	NULL	05HY027HLA013-04	05A803-TB POWER-08	16	BK	1N						220 VAC	05A550CB03		TSB		15.3.2004
	NULL	05HY027HLA013-CHASSIS	05W1D	16	WH							FRM GND			TSB		15.3.2004
	NULL	05HY027HLA014-01	05HY027HLA013-01	16	WH	1N						220VACN	05A550CB03		TSB		15.3.2004
	NULL	05HY027HLA014-03	05HY027HLA013-03	16	WH	1N						220VACN	05A550CB03		TSB		15.3.2004
	NULL	05HY027HLA014-04	05A803-TB POWER-10	16	BK	1N						220 VAC	05A550CB03		TSB		15.3.2004
	NULL	05HY027HLA014-CHASSIS	05W1D	16	WH							FRM GND			TSB		15.3.2004
	NULL	05HY027HLA015-01	05HY027HLA016-01	16	WH	1N						220VACN	05A550CB03		TSB		15.3.2004
	NULL	05HY027HLA015-03	05HY027HLA016-03	16	WH	1N						220VACN	05A550CB03		TSB		15.3.2004
	NULL	05HY027HLA015-04	05A803-TB POWER-12	16	BK	1N						220 VAC	05A550CB03		TSB		15.3.2004
	NULL	05HY027HLA015-CHASSIS	05W1D	16	WH							FRM GND			TSB		15.3.2004
	NULL	05HY027HLA016-01	05HY027HLA017-01	16	WH	1N						220VACN	05A550CB03		TSB		15.3.2004
	NULL	05HY027HLA016-03	05HY027HLA017-03	16	WH	1N						220VACN	05A550CB03		TSB		15.3.2004
	NULL	05HY027HLA016-04	05A803-TB POWER-14	16	BK	1N						220 VAC	05A550CB03		TSB		15.3.2004
	NULL	05HY027HLA016-CHASSIS	05W1D	16	WH							FRM GND			TSB		15.3.2004
	NULL	05HY027HLA017-01	05HY027HLA018-01	16	WH	1N						220VACN	05A550CB03		TSB		15.3.2004
	NULL	05HY027HLA017-03	05HY027HLA018-03	16	WH	1N						220VACN	05A550CB03		TSB		15.3.2004
	NULL	05HY027HLA017-04	05A803-TB POWER-16	16	BK	1N						220 VAC	05A550CB03		TSB		15.3.2004
	NULL	05HY027HLA017-CHASSIS	05W1D	16	WH							FRM GND			TSB		15.3.2004
	NULL	05HY027HLA018-01	05HY027HLA019-01	16	WH	1N						220VACN	05A550CB03		TSB		15.3.2004
	NULL	05HY027HLA018-03	05HY027HLA019-03	16	WH	1N						220VACN	05A550CB03		TSB		15.3.2004
	NULL	05HY027HLA018-04	05A803-TB POWER-18	16	BK	1N						220 VAC	05A550CB03		TSB		15.3.2004
	NULL	05HY027HLA018-CHASSIS	05W1D	16	WH							FRM GND			TSB		15.3.2004
	NULL	05HY027HLA019-01	05HY027HLA020-01	16	WH	1N						220VACN	05A550CB03		TSB		15.3.2004
	NULL	05HY027HLA019-03	05HY027HLA020-03	16	WH	1N						220VACN	05A550CB03		TSB		15.3.2004
	NULL	05HY027HLA019-04	05A803-TB POWER-20	16	BK	1N						220 VAC	05A550CB03		TSB		15.3.2004
	NULL	05HY027HLA019-CHASSIS	05W1D	16	WH							FRM GND			TSB		15.3.2004
	NULL	05HY027HLA020-01	05HY027HLA021-01	16	WH	1N						220VACN	05A550CB03		TSB		15.3.2004
	NULL	05HY027HLA020-03	05HY027HLA021-03	16	WH	1N						220VACN	05A550CB03		TSB		15.3.2004

coord	coord_	From	To	WC	CC	NC	IO	SC	Word	bit	remarks	power	origin	daisy_	ped	rev_le	write_date
	NULL	05HY027HLA020-04	05A803-TB POWER-22	16	BK	1N						220 VAC	05A550CB03		TSB		15.3.2004
	NULL	05HY027HLA020-CHASSIS	05W1D	16	WH							FRM GND			TSB		15.3.2004
	NULL	05HY027HLA021-01	05HY027HLA025-01	16	WH	1N						220VACN	05A550CB03		TSB		15.3.2004
	NULL	05HY027HLA021-03	05HY027HLA025-03	16	WH	1N						220VACN	05A550CB03		TSB		15.3.2004
	NULL	05HY027HLA021-04	05A803-TB POWER-24	16	BK	1N						220 VAC	05A550CB03		TSB		15.3.2004
	NULL	05HY027HLA021-CHASSIS	05W1D	16	WH							FRM GND			TSB		15.3.2004
	NULL	05HY027HLA022-04	05A803-TB POWER-26	16	BK	1N						220 VAC	05A550CB03		TSB		15.3.2004
	NULL	05HY027HLA022-CHASSIS	05W1D	16	WH							FRM GND			TSB		15.3.2004
	NULL	05HY027HLA023-01	05HY027HLA022-01	16	WH	1N						220VACN	05A550CB03		TSB		15.3.2004
	NULL	05HY027HLA023-03	05HY027HLA022-03	16	WH	1N						220VACN	05A550CB03		TSB		15.3.2004
	NULL	05HY027HLA023-04	05A803-TB POWER-28	16	BK	1N						220 VAC	05A550CB03		TSB		15.3.2004
	NULL	05HY027HLA023-CHASSIS	05W1D	16	WH							FRM GND			TSB		15.3.2004
	NULL	05HY027HLA024-01	05HY027HLA023-01	16	WH	1N						220VACN	05A550CB03		TSB		15.3.2004
	NULL	05HY027HLA024-03	05HY027HLA023-03	16	WH	1N						220VACN	05A550CB03		TSB		15.3.2004
	NULL	05HY027HLA024-04	05A803-TB POWER-30	16	BK	1N						220 VAC	05A550CB03		TSB		15.3.2004
	NULL	05HY027HLA024-CHASSIS	05W1D	16	WH							FRM GND			TSB		15.3.2004
	NULL	05HY027HLA025-01	05HY027HLA024-01	16	WH	1N						220VACN	05A550CB03		TSB		15.3.2004
	NULL	05HY027HLA025-03	05HY027HLA024-03	16	WH	1N						220VACN	05A550CB03		TSB		15.3.2004
	NULL	05HY027HLA025-04	05A803-TB POWER-32	16	BK	1N						220 VAC	05A550CB03		TSB		15.3.2004
	NULL	05HY027HLA025-CHASSIS	05W1D	16	WH							FRM GND			TSB		15.3.2004
	NULL	05HY027HLA026-01	05A681-K02-04	16	WH	1N						220VACN	05A550CB04		TSB		15.3.2004
	NULL	05HY027HLA026-01	05HY027HLA027-01	16	WH	1N						220VACN	05A550CB04		TSB		15.3.2004
	NULL	05HY027HLA026-03	05A681-K01-04	16	WH	1N						220VACN	05A550CB04		TSB		15.3.2004
	NULL	05HY027HLA026-03	05HY027HLA027-03	16	WH	1N						220VACN	05A550CB04		TSB		15.3.2004
	NULL	05HY027HLA026-04	05A804-TB POWER-02	16	BK	1N						220 VAC	05A550CB04		TSB		15.3.2004
	NULL	05HY027HLA026-CHASSIS	05W1D	16	WH							FRM GND			TSB		15.3.2004
	NULL	05HY027HLA027-01	05HY027HLA028-01	16	WH	1N						220VACN	05A550CB04		TSB		15.3.2004
	NULL	05HY027HLA027-03	05HY027HLA028-03	16	WH	1N						220VACN	05A550CB04		TSB		15.3.2004
	NULL	05HY027HLA027-04	05A804-TB POWER-04	16	BK	1N						220 VAC	05A550CB04		TSB		15.3.2004
	NULL	05HY027HLA027-CHASSIS	05W1D	16	WH							FRM GND			TSB		15.3.2004
	NULL	05HY027HLA028-01	05HY027HLA035-01	16	WH	1N						220VACN	05A550CB04		TSB		15.3.2004
	NULL	05HY027HLA028-03	05HY027HLA035-03	16	WH	1N						220VACN	05A550CB04		TSB		15.3.2004
	NULL	05HY027HLA028-04	05A804-TB POWER-06	16	BK	1N						220 VAC	05A550CB04		TSB		15.3.2004
	NULL	05HY027HLA028-CHASSIS	05W1D	16	WH							FRM GND			TSB		15.3.2004
	NULL	05HY027HLA029-01	05HY027HLA036-01	16	WH	1N						220VACN	05A550CB04		TSB		15.3.2004
	NULL	05HY027HLA029-03	05HY027HLA036-03	16	WH	1N						220VACN	05A550CB04		TSB		15.3.2004
	NULL	05HY027HLA029-04	05A804-TB POWER-08	16	BK	1N						220 VAC	05A550CB04		TSB		15.3.2004
	NULL	05HY027HLA029-CHASSIS	05W1E	16	WH							FRM GND			TSB		15.3.2004
	NULL	05HY027HLA030-01	05HY027HLA029-01	16	WH	1N						220VACN	05A550CB04		TSB		15.3.2004
	NULL	05HY027HLA030-03	05HY027HLA029-03	16	WH	1N						220VACN	05A550CB04		TSB		15.3.2004
	NULL	05HY027HLA030-04	05A804-TB POWER-10	16	BK	1N						220 VAC	05A550CB04		TSB		15.3.2004
	NULL	05HY027HLA030-CHASSIS	05W1E	16	WH							FRM GND			TSB		15.3.2004
	NULL	05HY027HLA031-01	05HY027HLA030-01	16	WH	1N						220VACN	05A550CB04		TSB		15.3.2004
	NULL	05HY027HLA031-03	05HY027HLA030-03	16	WH	1N						220VACN	05A550CB04		TSB		15.3.2004
	NULL	05HY027HLA031-04	05A804-TB POWER-12	16	BK	1N						220 VAC	05A550CB04		TSB		15.3.2004
	NULL	05HY027HLA031-CHASSIS	05W1E	16	WH							FRM GND			TSB		15.3.2004
	NULL	05HY027HLA032-01	05HY027HLA031-01	16	WH	1N						220VACN	05A550CB04		TSB		15.3.2004
	NULL	05HY027HLA032-03	05HY027HLA031-03	16	WH	1N						220VACN	05A550CB04		TSB		15.3.2004
	NULL	05HY027HLA032-04	05A804-TB POWER-14	16	BK	1N						220 VAC	05A550CB04		TSB		15.3.2004
	NULL	05HY027HLA032-CHASSIS	05W1E	16	WH							FRM GND			TSB		15.3.2004
	NULL	05HY027HLA033-01	05HY027HLA032-01	16	WH	1N						220VACN	05A550CB04		TSB		15.3.2004
	NULL	05HY027HLA033-03	05HY027HLA032-03	16	WH	1N						220VACN	05A550CB04		TSB		15.3.2004
	NULL	05HY027HLA033-04	05A804-TB POWER-16	16	BK	1N						220 VAC	05A550CB04		TSB		15.3.2004
	NULL	05HY027HLA033-CHASSIS	05W1E	16	WH							FRM GND			TSB		15.3.2004

coord	coord_	From	To	WC	CC	NC	IO	SC	Word	bit	remarks	power	origin	daisy_	ped	rev_le	write_date
	NULL	05HY027HLA034-01	05HY027HLA033-01	16	WH	1N						220VACN	05A550CB04		TSB		15.3.2004
	NULL	05HY027HLA034-03	05HY027HLA033-03	16	WH	1N						220VACN	05A550CB04		TSB		15.3.2004
	NULL	05HY027HLA034-04	05A804-TB POWER-18	16	BK	1N						220 VAC	05A550CB04		TSB		15.3.2004
	NULL	05HY027HLA034-CHASSIS	05W1E	16	WH							FRM GND			TSB		15.3.2004
	NULL	05HY027HLA035-01	05HY027HLA034-01	16	WH	1N						220VACN	05A550CB04		TSB		15.3.2004
	NULL	05HY027HLA035-03	05HY027HLA034-03	16	WH	1N						220VACN	05A550CB04		TSB		15.3.2004
	NULL	05HY027HLA035-04	05A804-TB POWER-20	16	BK	1N						220 VAC	05A550CB04		TSB		15.3.2004
	NULL	05HY027HLA035-CHASSIS	05W1E	16	WH							FRM GND			TSB		15.3.2004
	NULL	05HY027HLA036-01	05HY027HLA037-01	16	WH	1N						220VACN	05A550CB04		TSB		15.3.2004
	NULL	05HY027HLA036-03	05HY027HLA037-03	16	WH	1N						220VACN	05A550CB04		TSB		15.3.2004
	NULL	05HY027HLA036-04	05A804-TB POWER-22	16	BK	1N						220 VAC	05A550CB04		TSB		15.3.2004
	NULL	05HY027HLA036-CHASSIS	05W1E	16	WH							FRM GND			TSB		15.3.2004
	NULL	05HY027HLA037-01	05HY027HLA038-01	16	WH	1N						220VACN	05A550CB04		TSB		15.3.2004
	NULL	05HY027HLA037-03	05HY027HLA038-03	16	WH	1N						220VACN	05A550CB04		TSB		15.3.2004
	NULL	05HY027HLA037-04	05A804-TB POWER-24	16	BK	1N						220 VAC	05A550CB04		TSB		15.3.2004
	NULL	05HY027HLA037-CHASSIS	05W1E	16	WH							FRM GND			TSB		15.3.2004
	NULL	05HY027HLA038-01	05HY027HLA039-01	16	WH	1N						220VACN	05A550CB04		TSB		15.3.2004
	NULL	05HY027HLA038-03	05HY027HLA039-03	16	WH	1N						220VACN	05A550CB04		TSB		15.3.2004
	NULL	05HY027HLA038-04	05A804-TB POWER-26	16	BK	1N						220 VAC	05A550CB04		TSB		15.3.2004
	NULL	05HY027HLA038-CHASSIS	05W1E	16	WH							FRM GND			TSB		15.3.2004
	NULL	05HY027HLA039-01	05HY027HLA040-01	16	WH	1N						220VACN	05A550CB04		TSB		15.3.2004
	NULL	05HY027HLA039-03	05HY027HLA040-03	16	WH	1N						220VACN	05A550CB04		TSB		15.3.2004
	NULL	05HY027HLA039-04	05A804-TB POWER-28	16	BK	1N						220 VAC	05A550CB04		TSB		15.3.2004
	NULL	05HY027HLA039-CHASSIS	05W1E	16	WH							FRM GND			TSB		15.3.2004
	NULL	05HY027HLA040-01	05HY027HLA041-01	16	WH	1N						220VACN	05A550CB04		TSB		15.3.2004
	NULL	05HY027HLA040-03	05HY027HLA041-03	16	WH	1N						220VACN	05A550CB04		TSB		15.3.2004
	NULL	05HY027HLA040-04	05A804-TB POWER-30	16	BK	1N						220 VAC	05A550CB04		TSB		15.3.2004
	NULL	05HY027HLA040-CHASSIS	05W1E	16	WH							FRM GND			TSB		15.3.2004
	NULL	05HY027HLA041-01	05HY027HLA042-01	16	WH	1N						220VACN	05A550CB04		TSB		15.3.2004
	NULL	05HY027HLA041-03	05HY027HLA042-03	16	WH	1N						220VACN	05A550CB04		TSB		15.3.2004
	NULL	05HY027HLA041-04	05A804-TB POWER-32	16	BK	1N						220 VAC	05A550CB04		TSB		15.3.2004
	NULL	05HY027HLA041-CHASSIS	05W1E	16	WH							FRM GND			TSB		15.3.2004
	NULL	05HY027HLA042-01	05HY027HLA049-01	16	WH	1N						220VACN	05A550CB04		TSB		15.3.2004
	NULL	05HY027HLA042-03	05HY027HLA049-03	16	WH	1N						220VACN	05A550CB04		TSB		15.3.2004
	NULL	05HY027HLA042-04	05A805-TB POWER-02	16	BK	1N						220 VAC	05A550CB04		TSB		15.3.2004
	NULL	05HY027HLA042-CHASSIS	05W1E	16	WH							FRM GND			TSB		15.3.2004
	NULL	05HY027HLA043-01	05HY027HLA050-01	16	WH	1N						220VACN	05A550CB04		TSB		15.3.2004
	NULL	05HY027HLA043-03	05HY027HLA050-03	16	WH	1N						220VACN	05A550CB04		TSB		15.3.2004
	NULL	05HY027HLA043-04	05A805-TB POWER-04	16	BK	1N						220 VAC	05A550CB04		TSB		15.3.2004
	NULL	05HY027HLA043-CHASSIS	05W1E	16	WH							FRM GND			TSB		15.3.2004
	NULL	05HY027HLA044-01	05HY027HLA043-01	16	WH	1N						220VACN	05A550CB04		TSB		15.3.2004
	NULL	05HY027HLA044-03	05HY027HLA043-03	16	WH	1N						220VACN	05A550CB04		TSB		15.3.2004
	NULL	05HY027HLA044-04	05A805-TB POWER-06	16	BK	1N						220 VAC	05A550CB04		TSB		15.3.2004
	NULL	05HY027HLA044-CHASSIS	05W1E	16	WH							FRM GND			TSB		15.3.2004
	NULL	05HY027HLA045-01	05HY027HLA044-01	16	WH	1N						220VACN	05A550CB04		TSB		15.3.2004
	NULL	05HY027HLA045-03	05HY027HLA044-03	16	WH	1N						220VACN	05A550CB04		TSB		15.3.2004
	NULL	05HY027HLA045-04	05A805-TB POWER-08	16	BK	1N						220 VAC	05A550CB04		TSB		15.3.2004
	NULL	05HY027HLA045-CHASSIS	05W1E	16	WH							FRM GND			TSB		15.3.2004
	NULL	05HY027HLA046-01	05HY027HLA045-01	16	WH	1N						220VACN	05A550CB04		TSB		15.3.2004
	NULL	05HY027HLA046-03	05HY027HLA045-03	16	WH	1N						220VACN	05A550CB04		TSB		15.3.2004
	NULL	05HY027HLA046-04	05A805-TB POWER-10	16	BK	1N						220 VAC	05A550CB04		TSB		15.3.2004
	NULL	05HY027HLA046-CHASSIS	05W1E	16	WH							FRM GND			TSB		15.3.2004
	NULL	05HY027HLA047-01	05HY027HLA046-01	16	WH	1N						220VACN	05A550CB04		TSB		15.3.2004
	NULL	05HY027HLA047-03	05HY027HLA046-03	16	WH	1N						220VACN	05A550CB04		TSB		15.3.2004

coord	coord_	From	To	WC	CC	NC	IO	SC	Word	bit	remarks	power	origin	daisy_	ped	rev_le	write_date
	NULL	05HY027HLA047-04	05A805-TB POWER-12	16	BK	1N						220 VAC	05A550CB04		TSB		15.3.2004
	NULL	05HY027HLA047-CHASSIS	05W1E	16	WH							FRM GND			TSB		15.3.2004
	NULL	05HY027HLA048-01	05HY027HLA047-01	16	WH	1N						220VACN	05A550CB04		TSB		15.3.2004
	NULL	05HY027HLA048-03	05HY027HLA047-03	16	WH	1N						220VACN	05A550CB04		TSB		15.3.2004
	NULL	05HY027HLA048-04	05A805-TB POWER-14	16	BK	1N						220 VAC	05A550CB04		TSB		15.3.2004
	NULL	05HY027HLA048-CHASSIS	05W1E	16	WH							FRM GND			TSB		15.3.2004
	NULL	05HY027HLA049-01	05HY027HLA048-01	16	WH	1N						220VACN	05A550CB04		TSB		15.3.2004
	NULL	05HY027HLA049-03	05HY027HLA048-03	16	WH	1N						220VACN	05A550CB04		TSB		15.3.2004
	NULL	05HY027HLA049-04	05A805-TB POWER-16	16	BK	1N						220 VAC	05A550CB04		TSB		15.3.2004
	NULL	05HY027HLA049-CHASSIS	05W1E	16	WH							FRM GND			TSB		15.3.2004
	NULL	05HY027HLA050-01	05HY027HLA051-01	16	WH	1N						220VACN	05A550CB04		TSB		15.3.2004
	NULL	05HY027HLA050-03	05HY027HLA051-03	16	WH	1N						220VACN	05A550CB04		TSB		15.3.2004
	NULL	05HY027HLA050-04	05A805-TB POWER-18	16	BK	1N						220 VAC	05A550CB04		TSB		15.3.2004
	NULL	05HY027HLA050-CHASSIS	05W1E	16	WH							FRM GND			TSB		15.3.2004
	NULL	05HY027HLA051-01	05HY027HLA052-01	16	WH	1N						220VACN	05A550CB04		TSB		15.3.2004
	NULL	05HY027HLA051-03	05HY027HLA052-03	16	WH	1N						220VACN	05A550CB04		TSB		15.3.2004
	NULL	05HY027HLA051-04	05A805-TB POWER-20	16	BK	1N						220 VAC	05A550CB04		TSB		15.3.2004
	NULL	05HY027HLA051-CHASSIS	05W1E	16	WH							FRM GND			TSB		15.3.2004
	NULL	05HY027HLA052-01	05HY027HLA053-01	16	WH	1N						220VACN	05A550CB04		TSB		15.3.2004
	NULL	05HY027HLA052-03	05HY027HLA053-03	16	WH	1N						220VACN	05A550CB04		TSB		15.3.2004
	NULL	05HY027HLA052-04	05A805-TB POWER-22	16	BK	1N						220 VAC	05A550CB04		TSB		15.3.2004
	NULL	05HY027HLA052-CHASSIS	05W1E	16	WH							FRM GND			TSB		15.3.2004
	NULL	05HY027HLA053-01	05HY027HLA054-01	16	WH	1N						220VACN	05A550CB04		TSB		15.3.2004
	NULL	05HY027HLA053-03	05HY027HLA054-03	16	WH	1N						220VACN	05A550CB04		TSB		15.3.2004
	NULL	05HY027HLA053-04	05A805-TB POWER-24	16	BK	1N						220 VAC	05A550CB04		TSB		15.3.2004
	NULL	05HY027HLA053-CHASSIS	05W1E	16	WH							FRM GND			TSB		15.3.2004
	NULL	05HY027HLA054-01	05HY027HLA055-01	16	WH	1N						220VACN	05A550CB04		TSB		15.3.2004
	NULL	05HY027HLA054-03	05HY027HLA055-03	16	WH	1N						220VACN	05A550CB04		TSB		15.3.2004
	NULL	05HY027HLA054-04	05A805-TB POWER-26	16	BK	1N						220 VAC	05A550CB04		TSB		15.3.2004
	NULL	05HY027HLA054-CHASSIS	05W1E	16	WH							FRM GND			TSB		15.3.2004
	NULL	05HY027HLA055-01	05HY027HLA056-01	16	WH	1N						220VACN	05A550CB04		TSB		15.3.2004
	NULL	05HY027HLA055-03	05HY027HLA056-03	16	WH	1N						220VACN	05A550CB04		TSB		15.3.2004
	NULL	05HY027HLA055-04	05A805-TB POWER-28	16	BK	1N						220 VAC	05A550CB04		TSB		15.3.2004
	NULL	05HY027HLA055-CHASSIS	05W1E	16	WH							FRM GND			TSB		15.3.2004
	NULL	05HY027HLA056-04	05A805-TB POWER-30	16	BK	1N						220 VAC	05A550CB04		TSB		15.3.2004
	NULL	05HY027HLA056-CHASSIS	05W1E	16	WH							FRM GND			TSB		15.3.2004
	NULL	05HY027HLA057-01	05HY027HLA066-01	16	WH	1N						220VACN	05A550CB04		TSB		15.3.2004
	NULL	05HY027HLA057-03	05HY027HLA066-03	16	WH	1N						220VACN	05A550CB04		TSB		15.3.2004
	NULL	05HY027HLA057-04	05A805-TB POWER-32	16	BK	1N						220 VAC	05A550CB04		TSB		15.3.2004
	NULL	05HY027HLA057-CHASSIS	05W1C	16	WH							FRM GND			TSB		15.3.2004
	NULL	05HY027HLA058-01	05HY027HLA057-01	16	WH	1N						220VACN	05A550CB04		TSB		15.3.2004
	NULL	05HY027HLA058-03	05HY027HLA057-03	16	WH	1N						220VACN	05A550CB04		TSB		15.3.2004
	NULL	05HY027HLA058-04	05A806-TB POWER-02	16	BK	1N						220 VAC	05A550CB04		TSB		15.3.2004
	NULL	05HY027HLA058-CHASSIS	05W1C	16	WH							FRM GND			TSB		15.3.2004
	NULL	05HY027HLA059-01	05HY027HLA058-01	16	WH	1N						220VACN	05A550CB04		TSB		15.3.2004
	NULL	05HY027HLA059-03	05HY027HLA058-03	16	WH	1N						220VACN	05A550CB04		TSB		15.3.2004
	NULL	05HY027HLA059-04	05A806-TB POWER-04	16	BK	1N						220 VAC	05A550CB04		TSB		15.3.2004
	NULL	05HY027HLA059-CHASSIS	05W1C	16	WH							FRM GND			TSB		15.3.2004
	NULL	05HY027HLA060-01	05HY027HLA059-01	16	WH	1N						220VACN	05A550CB04		TSB		15.3.2004
	NULL	05HY027HLA060-03	05HY027HLA059-03	16	WH	1N						220VACN	05A550CB04		TSB		15.3.2004
	NULL	05HY027HLA060-04	05A806-TB POWER-06	16	BK	1N						220 VAC	05A550CB04		TSB		15.3.2004
	NULL	05HY027HLA060-CHASSIS	05W1C	16	WH							FRM GND			TSB		15.3.2004
	NULL	05HY027HLA061-01	05HY027HLA060-01	16	WH	1N						220VACN	05A550CB04		TSB		15.3.2004
	NULL	05HY027HLA061-03	05HY027HLA060-03	16	WH	1N						220VACN	05A550CB04		TSB		15.3.2004

coord	coord_	From	To	WC	CC	NC	IO	SC	Word	bit	remarks	power	origin	daisy_	ped	rev_le	write_date
	NULL	05HY027HLA061-04	05A806-TB POWER-08	16	BK	1N						220 VAC	05A550CB04		TSB		15.3.2004
	NULL	05HY027HLA061-CHASSIS	05W1C	16	WH							FRM GND			TSB		15.3.2004
	NULL	05HY027HLA062-01	05HY027HLA061-01	16	WH	1N						220VACN	05A550CB04		TSB		15.3.2004
	NULL	05HY027HLA062-03	05HY027HLA061-03	16	WH	1N						220VACN	05A550CB04		TSB		15.3.2004
	NULL	05HY027HLA062-04	05A806-TB POWER-10	16	BK	1N						220 VAC	05A550CB04		TSB		15.3.2004
	NULL	05HY027HLA062-CHASSIS	05W1C	16	WH							FRM GND			TSB		15.3.2004
	NULL	05HY027HLA063-01	05HY027HLA062-01	16	WH	1N						220VACN	05A550CB04		TSB		15.3.2004
	NULL	05HY027HLA063-03	05HY027HLA062-03	16	WH	1N						220VACN	05A550CB04		TSB		15.3.2004
	NULL	05HY027HLA063-04	05A806-TB POWER-12	16	BK	1N						220 VAC	05A550CB04		TSB		15.3.2004
	NULL	05HY027HLA063-CHASSIS	05W1C	16	WH							FRM GND			TSB		15.3.2004
	NULL	05HY027HLA064-01	05HY027HLA063-01	16	WH	1N						220VACN	05A550CB04		TSB		15.3.2004
	NULL	05HY027HLA064-03	05HY027HLA063-03	16	WH	1N						220VACN	05A550CB04		TSB		15.3.2004
	NULL	05HY027HLA064-04	05A806-TB POWER-14	16	BK	1N						220 VAC	05A550CB04		TSB		15.3.2004
	NULL	05HY027HLA064-CHASSIS	05W1C	16	WH							FRM GND			TSB		15.3.2004
	NULL	05HY027HLA065-01	05HY027HLA064-01	16	WH	1N						220VACN	05A550CB04		TSB		15.3.2004
	NULL	05HY027HLA065-03	05HY027HLA064-03	16	WH	1N						220VACN	05A550CB04		TSB		15.3.2004
	NULL	05HY027HLA065-04	05A806-TB POWER-16	16	BK	1N						220 VAC	05A550CB04		TSB		15.3.2004
	NULL	05HY027HLA065-CHASSIS	05W1C	16	WH							FRM GND			TSB		15.3.2004
	NULL	05HY027HLA066-01	05HY027HLA067-01	16	WH	1N						220VACN	05A550CB04		TSB		15.3.2004
	NULL	05HY027HLA066-03	05HY027HLA067-03	16	WH	1N						220VACN	05A550CB04		TSB		15.3.2004
	NULL	05HY027HLA066-04	05A806-TB POWER-18	16	BK	1N						220 VAC	05A550CB04		TSB		15.3.2004
	NULL	05HY027HLA066-CHASSIS	05W1C	16	WH							FRM GND			TSB		15.3.2004
	NULL	05HY027HLA067-01	05HY027HLA068-01	16	WH	1N						220VACN	05A550CB04		TSB		15.3.2004
	NULL	05HY027HLA067-03	05HY027HLA068-03	16	WH	1N						220VACN	05A550CB04		TSB		15.3.2004
	NULL	05HY027HLA067-04	05A806-TB POWER-20	16	BK	1N						220 VAC	05A550CB04		TSB		15.3.2004
	NULL	05HY027HLA067-CHASSIS	05W1C	16	WH							FRM GND			TSB		15.3.2004
	NULL	05HY027HLA068-01	05HY027HLA069-01	16	WH	1N						220VACN	05A550CB04		TSB		15.3.2004
	NULL	05HY027HLA068-03	05HY027HLA069-03	16	WH	1N						220VACN	05A550CB04		TSB		15.3.2004
	NULL	05HY027HLA068-04	05A806-TB POWER-22	16	BK	1N						220 VAC	05A550CB04		TSB		15.3.2004
	NULL	05HY027HLA068-CHASSIS	05W1C	16	WH							FRM GND			TSB		15.3.2004
	NULL	05HY027HLA069-01	05HY027HLA070-01	16	WH	1N						220VACN	05A550CB04		TSB		15.3.2004
	NULL	05HY027HLA069-03	05HY027HLA070-03	16	WH	1N						220VACN	05A550CB04		TSB		15.3.2004
	NULL	05HY027HLA069-04	05A806-TB POWER-24	16	BK	1N						220 VAC	05A550CB04		TSB		15.3.2004
	NULL	05HY027HLA069-CHASSIS	05W1C	16	WH							FRM GND			TSB		15.3.2004
	NULL	05HY027HLA070-01	05HY027HLA071-01	16	WH	1N						220VACN	05A550CB04		TSB		15.3.2004
	NULL	05HY027HLA070-03	05HY027HLA071-03	16	WH	1N						220VACN	05A550CB04		TSB		15.3.2004
	NULL	05HY027HLA070-04	05A806-TB POWER-26	16	BK	1N						220 VAC	05A550CB04		TSB		15.3.2004
	NULL	05HY027HLA070-CHASSIS	05W1C	16	WH							FRM GND			TSB		15.3.2004
	NULL	05HY027HLA071-01	05HY027HLA072-01	16	WH	1N						220VACN	05A550CB04		TSB		15.3.2004
	NULL	05HY027HLA071-03	05HY027HLA072-03	16	WH	1N						220VACN	05A550CB04		TSB		15.3.2004
	NULL	05HY027HLA071-04	05A806-TB POWER-28	16	BK	1N						220 VAC	05A550CB04		TSB		15.3.2004
	NULL	05HY027HLA071-CHASSIS	05W1C	16	WH							FRM GND			TSB		15.3.2004
	NULL	05HY027HLA072-01	05HY027HLA073-01	16	WH	1N						220VACN	05A550CB04		TSB		15.3.2004
	NULL	05HY027HLA072-03	05HY027HLA073-03	16	WH	1N						220VACN	05A550CB04		TSB		15.3.2004
	NULL	05HY027HLA072-04	05A806-TB POWER-30	16	BK	1N						220 VAC	05A550CB04		TSB		15.3.2004
	NULL	05HY027HLA072-CHASSIS	05W1C	16	WH							FRM GND			TSB		15.3.2004
	NULL	05HY027HLA073-01	05HY027HLA074-01	16	WH	1N						220VACN	05A550CB04		TSB		15.3.2004
	NULL	05HY027HLA073-03	05HY027HLA074-03	16	WH	1N						220VACN	05A550CB04		TSB		15.3.2004
	NULL	05HY027HLA073-04	05A806-TB POWER-32	16	BK	1N						220 VAC	05A550CB04		TSB		15.3.2004
	NULL	05HY027HLA073-CHASSIS	05W1C	16	WH							FRM GND			TSB		15.3.2004
	NULL	05HY027HLA074-01	05A680-K11-NC	16	WH	1N						220VACN	05A550CB04		TSB	A	15.3.2004
	NULL	05HY027HLA074-03	05A680-K08-NC	16	WH	1N						220VACN	05A550CB04		TSB	A	15.3.2004
	NULL	05HY027HLA074-04	05A807-TB POWER-02	16	BK	1N						220 VAC	05A550CB04		TSB		15.3.2004
	NULL	05HY027HLA074-CHASSIS	05W1C	16	WH							FRM GND			TSB		15.3.2004

coord	coord_	From	To	WC	CC	NC	IO	SC	Word	bit	remarks	power	origin	daisy_	ped	rev_le	write_date
	NULL	05A802-TB SIGNAL-16	05A530-A2P10-08	22	WH		LO	1	071	07	05HY027HLA001				TSB		15.3.2004
	NULL	05A802-TB SIGNAL-18	05A530-A2P10-09	22	WH		LO	1	071	08	05HY027HLA002				TSB		15.3.2004
	NULL	05A802-TB SIGNAL-20	05A530-A2P10-10	22	WH		LO	1	071	09	05HY027HLA003				TSB		15.3.2004
	NULL	05A802-TB SIGNAL-22	05A530-A2P10-11	22	WH		LO	1	071	10	05HY027HLA004				TSB		15.3.2004
	NULL	05A802-TB SIGNAL-24	05A530-A2P10-12	22	WH		LO	1	071	11	05HY027HLA005				TSB		15.3.2004
	NULL	05A802-TB SIGNAL-26	05A530-A2P10-13	22	WH		LO	1	071	12	05HY027HLA006				TSB		15.3.2004
	NULL	05A802-TB SIGNAL-28	05A530-A2P10-14	22	WH		LO	1	071	13	05HY027HLA007				TSB		15.3.2004
	NULL	05A802-TB SIGNAL-30	05A530-A2P10-15	22	WH		LO	1	071	14	05HY027HLA008				TSB		15.3.2004
	NULL	05A802-TB SIGNAL-32	05A530-A2P10-16	22	WH		LO	1	071	15	05HY027HLA009				TSB		15.3.2004
	NULL	05A803-TB SIGNAL-02	05A530-A2P11-01	22	WH		LO	1	072	00	05HY027HLA010				TSB		15.3.2004
	NULL	05A803-TB SIGNAL-04	05A530-A2P11-02	22	WH		LO	1	072	01	05HY027HLA011				TSB		15.3.2004
	NULL	05A803-TB SIGNAL-06	05A530-A2P11-03	22	WH		LO	1	072	02	05HY027HLA012				TSB		15.3.2004
	NULL	05A803-TB SIGNAL-08	05A530-A2P11-04	22	WH		LO	1	072	03	05HY027HLA013				TSB		15.3.2004
	NULL	05A803-TB SIGNAL-10	05A530-A2P11-05	22	WH		LO	1	072	04	05HY027HLA014				TSB		15.3.2004
	NULL	05A803-TB SIGNAL-12	05A530-A2P11-06	22	WH		LO	1	072	05	05HY027HLA015				TSB		15.3.2004
	NULL	05A803-TB SIGNAL-14	05A530-A2P11-07	22	WH		LO	1	072	06	05HY027HLA016				TSB		15.3.2004
	NULL	05A803-TB SIGNAL-16	05A530-A2P11-08	22	WH		LO	1	072	07	05HY027HLA017				TSB		15.3.2004
	NULL	05A803-TB SIGNAL-18	05A530-A2P11-09	22	WH		LO	1	072	08	05HY027HLA018				TSB		15.3.2004
	NULL	05A803-TB SIGNAL-20	05A530-A2P11-10	22	WH		LO	1	072	09	05HY027HLA019				TSB		15.3.2004
	NULL	05A803-TB SIGNAL-22	05A530-A2P11-11	22	WH		LO	1	072	10	05HY027HLA020				TSB		15.3.2004
	NULL	05A803-TB SIGNAL-24	05A530-A2P11-12	22	WH		LO	1	072	11	05HY027HLA021				TSB		15.3.2004
	NULL	05A803-TB SIGNAL-26	05A530-A2P11-13	22	WH		LO	1	072	12	05HY027HLA022				TSB		15.3.2004
	NULL	05A803-TB SIGNAL-28	05A530-A2P11-14	22	WH		LO	1	072	13	05HY027HLA023				TSB		15.3.2004
	NULL	05A803-TB SIGNAL-30	05A530-A2P11-15	22	WH		LO	1	072	14	05HY027HLA024				TSB		15.3.2004
	NULL	05A803-TB SIGNAL-32	05A530-A2P11-16	22	WH		LO	1	072	15	05HY027HLA025				TSB		15.3.2004
	NULL	05A804-TB SIGNAL-02	05A530-A2P12-01	22	WH		LO	1	073	00	05HY027HLA026				TSB		15.3.2004
	NULL	05A804-TB SIGNAL-04	05A530-A2P12-02	22	WH		LO	1	073	01	05HY027HLA027				TSB		15.3.2004
	NULL	05A804-TB SIGNAL-06	05A530-A2P12-03	22	WH		LO	1	073	02	05HY027HLA028				TSB		15.3.2004
	NULL	05A804-TB SIGNAL-08	05A530-A2P12-04	22	WH		LO	1	073	03	05HY027HLA029				TSB		15.3.2004
	NULL	05A804-TB SIGNAL-10	05A530-A2P12-05	22	WH		LO	1	073	04	05HY027HLA030				TSB		15.3.2004
	NULL	05A804-TB SIGNAL-12	05A530-A2P12-06	22	WH		LO	1	073	05	05HY027HLA031				TSB		15.3.2004
	NULL	05A804-TB SIGNAL-14	05A530-A2P12-07	22	WH		LO	1	073	06	05HY027HLA032				TSB		15.3.2004
	NULL	05A804-TB SIGNAL-16	05A530-A2P12-08	22	WH		LO	1	073	07	05HY027HLA033				TSB		15.3.2004
	NULL	05A804-TB SIGNAL-18	05A530-A2P12-09	22	WH		LO	1	073	08	05HY027HLA034				TSB		15.3.2004
	NULL	05A804-TB SIGNAL-20	05A530-A2P12-10	22	WH		LO	1	073	09	05HY027HLA035				TSB		15.3.2004
	NULL	05A804-TB SIGNAL-22	05A530-A2P12-11	22	WH		LO	1	073	10	05HY027HLA036				TSB		15.3.2004
	NULL	05A804-TB SIGNAL-24	05A530-A2P12-12	22	WH		LO	1	073	11	05HY027HLA037				TSB		15.3.2004
	NULL	05A804-TB SIGNAL-26	05A530-A2P12-13	22	WH		LO	1	073	12	05HY027HLA038				TSB		15.3.2004
	NULL	05A804-TB SIGNAL-28	05A530-A2P12-14	22	WH		LO	1	073	13	05HY027HLA039				TSB		15.3.2004
	NULL	05A804-TB SIGNAL-30	05A530-A2P12-15	22	WH		LO	1	073	14	05HY027HLA040				TSB		15.3.2004
	NULL	05A804-TB SIGNAL-32	05A530-A2P12-16	22	WH		LO	1	073	15	05HY027HLA041				TSB		15.3.2004
	NULL	05A805-TB SIGNAL-02	05A530-A2P13-01	22	WH		LO	1	074	00	05HY027HLA042				TSB		15.3.2004
	NULL	05A805-TB SIGNAL-04	05A530-A2P13-02	22	WH		LO	1	074	01	05HY027HLA043				TSB		15.3.2004
	NULL	05A805-TB SIGNAL-06	05A530-A2P13-03	22	WH		LO	1	074	02	05HY027HLA044				TSB		15.3.2004
	NULL	05A805-TB SIGNAL-08	05A530-A2P13-04	22	WH		LO	1	074	03	05HY027HLA045				TSB		15.3.2004
	NULL	05A805-TB SIGNAL-10	05A530-A2P13-05	22	WH		LO	1	074	04	05HY027HLA046				TSB		15.3.2004
	NULL	05A805-TB SIGNAL-12	05A530-A2P13-06	22	WH		LO	1	074	05	05HY027HLA047				TSB		15.3.2004
	NULL	05A805-TB SIGNAL-14	05A530-A2P13-07	22	WH		LO	1	074	06	05HY027HLA048				TSB		15.3.2004
	NULL	05A805-TB SIGNAL-16	05A530-A2P13-08	22	WH		LO	1	074	07	05HY027HLA049				TSB		15.3.2004
	NULL	05A805-TB SIGNAL-18	05A530-A2P13-09	22	WH		LO	1	074	08	05HY027HLA050				TSB		15.3.2004
	NULL	05A805-TB SIGNAL-20	05A530-A2P13-10	22	WH		LO	1	074	09	05HY027HLA051				TSB		15.3.2004
	NULL	05A805-TB SIGNAL-22	05A530-A2P13-11	22	WH		LO	1	074	10	05HY027HLA052				TSB		15.3.2004
	NULL	05A805-TB SIGNAL-24	05A530-A2P13-12	22	WH		LO	1	074	11	05HY027HLA053				TSB		15.3.2004

coord	coord_	From	To	WC	CC	NC	IO	SC	Word	bit	remarks	power	origin	daisy_	ped	rev_le	write_date
	NULL	05A805-TB SIGNAL-26	05A530-A2P13-13	22	WH		LO	1	074	12	05HY027HLA054				TSB		15.3.2004
	NULL	05A805-TB SIGNAL-28	05A530-A2P13-14	22	WH		LO	1	074	13	05HY027HLA055				TSB		15.3.2004
	NULL	05A805-TB SIGNAL-30	05A530-A2P13-15	22	WH		LO	1	074	14	05HY027HLA056				TSB		15.3.2004
	NULL	05A805-TB SIGNAL-32	05A530-A2P13-16	22	WH		LO	1	074	15	05HY027HLA057				TSB		15.3.2004
	NULL	05A806-TB SIGNAL-02	05A530-A2P14-01	22	WH		LO	1	075	00	05HY027HLA058				TSB		15.3.2004
	NULL	05A806-TB SIGNAL-04	05A530-A2P14-02	22	WH		LO	1	075	01	05HY027HLA059				TSB		15.3.2004
	NULL	05A806-TB SIGNAL-06	05A530-A2P14-03	22	WH		LO	1	075	02	05HY027HLA060				TSB		15.3.2004
	NULL	05A806-TB SIGNAL-08	05A530-A2P14-04	22	WH		LO	1	075	03	05HY027HLA061				TSB		15.3.2004
	NULL	05A806-TB SIGNAL-10	05A530-A2P14-05	22	WH		LO	1	075	04	05HY027HLA062				TSB		15.3.2004
	NULL	05A806-TB SIGNAL-12	05A530-A2P14-06	22	WH		LO	1	075	05	05HY027HLA063				TSB		15.3.2004
	NULL	05A806-TB SIGNAL-14	05A530-A2P14-07	22	WH		LO	1	075	06	05HY027HLA064				TSB		15.3.2004
	NULL	05A806-TB SIGNAL-16	05A530-A2P14-08	22	WH		LO	1	075	07	05HY027HLA065				TSB		15.3.2004
	NULL	05A806-TB SIGNAL-18	05A530-A2P14-09	22	WH		LO	1	075	08	05HY027HLA066				TSB		15.3.2004
	NULL	05A806-TB SIGNAL-20	05A530-A2P14-10	22	WH		LO	1	075	09	05HY027HLA067				TSB		15.3.2004
	NULL	05A806-TB SIGNAL-22	05A530-A2P14-11	22	WH		LO	1	075	10	05HY027HLA068				TSB		15.3.2004
	NULL	05A806-TB SIGNAL-24	05A530-A2P14-12	22	WH		LO	1	075	11	05HY027HLA069				TSB		15.3.2004
	NULL	05A806-TB SIGNAL-26	05A530-A2P14-13	22	WH		LO	1	075	12	05HY027HLA070				TSB		15.3.2004
	NULL	05A806-TB SIGNAL-28	05A530-A2P14-14	22	WH		LO	1	075	13	05HY027HLA071				TSB		15.3.2004
	NULL	05A806-TB SIGNAL-30	05A530-A2P14-15	22	WH		LO	1	075	14	05HY027HLA072				TSB		15.3.2004
	NULL	05A806-TB SIGNAL-32	05A530-A2P14-16	22	WH		LO	1	075	15	05HY027HLA073				TSB		15.3.2004
	NULL	05A807-TB SIGNAL-02	05A530-A2P15-01	22	WH		LO	1	076	00	05HY027HLA074				TSB		15.3.2004
HY28																	
	NULL	05HY028HLA001-01	05A680-K12-NC	16	WH	1N						220VACN	05A550CB04		TSB	A	15.3.2004
	NULL	05HY028HLA001-01	05HY028HLA002-01	16	WH	1N						220VACN	05A550CB04		TSB		15.3.2004
	NULL	05HY028HLA001-03	05A680-K09-NC	16	WH	1N						220VACN	05A550CB04		TSB	A	15.3.2004
	NULL	05HY028HLA001-03	05HY028HLA002-03	16	WH	1N						220VACN	05A550CB04		TSB		15.3.2004
	NULL	05HY028HLA001-04	05A807-TB POWER-04	16	BK	1N						220 VAC	05A550CB04		TSB		15.3.2004
	NULL	05HY028HLA001-CHASSIS	05W1F	16	WH							FRM GND			TSB		15.3.2004
	NULL	05HY028HLA002-01	05HY028HLA003-01	16	WH	1N						220VACN	05A550CB04		TSB		15.3.2004
	NULL	05HY028HLA002-03	05HY028HLA003-03	16	WH	1N						220VACN	05A550CB04		TSB		15.3.2004
	NULL	05HY028HLA002-04	05A807-TB POWER-06	16	BK	1N						220 VAC	05A550CB04		TSB		15.3.2004
	NULL	05HY028HLA002-CHASSIS	05W1F	16	WH							FRM GND			TSB		15.3.2004
	NULL	05HY028HLA003-01	05HY028HLA004-01	16	WH	1N						220VACN	05A550CB04		TSB		15.3.2004
	NULL	05HY028HLA003-03	05HY028HLA004-03	16	WH	1N						220VACN	05A550CB04		TSB		15.3.2004
	NULL	05HY028HLA003-04	05A807-TB POWER-08	16	BK	1N						220 VAC	05A550CB04		TSB		15.3.2004
	NULL	05HY028HLA003-CHASSIS	05W1F	16	WH							FRM GND			TSB		15.3.2004
	NULL	05HY028HLA004-01	05HY028HLA005-01	16	WH	1N						220VACN	05A550CB04		TSB		15.3.2004
	NULL	05HY028HLA004-03	05HY028HLA005-03	16	WH	1N						220VACN	05A550CB04		TSB		15.3.2004
	NULL	05HY028HLA004-04	05A807-TB POWER-10	16	BK	1N						220 VAC	05A550CB04		TSB		15.3.2004
	NULL	05HY028HLA004-CHASSIS	05W1F	16	WH							FRM GND			TSB		15.3.2004
	NULL	05HY028HLA005-01	05HY028HLA006-01	16	WH	1N						220VACN	05A550CB04		TSB		15.3.2004
	NULL	05HY028HLA005-03	05HY028HLA006-03	16	WH	1N						220VACN	05A550CB04		TSB		15.3.2004
	NULL	05HY028HLA005-04	05A807-TB POWER-12	16	BK	1N						220 VAC	05A550CB04		TSB		15.3.2004
	NULL	05HY028HLA005-CHASSIS	05W1F	16	WH							FRM GND			TSB		15.3.2004
	NULL	05HY028HLA006-01	05HY028HLA007-01	16	WH	1N						220VACN	05A550CB04		TSB		15.3.2004
	NULL	05HY028HLA006-03	05HY028HLA007-03	16	WH	1N						220VACN	05A550CB04		TSB		15.3.2004
	NULL	05HY028HLA006-04	05A807-TB POWER-14	16	BK	1N						220 VAC	05A550CB04		TSB		15.3.2004
	NULL	05HY028HLA006-CHASSIS	05W1F	16	WH							FRM GND			TSB		15.3.2004
	NULL	05HY028HLA007-01	05HY028HLA008-01	16	WH	1N						220VACN	05A550CB04		TSB		15.3.2004
	NULL	05HY028HLA007-03	05HY028HLA008-03	16	WH	1N						220VACN	05A550CB04		TSB		15.3.2004
	NULL	05HY028HLA007-04	05A807-TB POWER-16	16	BK	1N						220 VAC	05A550CB04		TSB		15.3.2004
	NULL	05HY028HLA007-CHASSIS	05W1F	16	WH							FRM GND			TSB		15.3.2004
	NULL	05HY028HLA008-01	05HY028HLA009-01	16	WH	1N						220VACN	05A550CB04		TSB		15.3.2004
	NULL	05HY028HLA008-03	05HY028HLA009-03	16	WH	1N						220VACN	05A550CB04		TSB		15.3.2004

coord	coord_	From	To	WC	CC	NC	IO	SC	Word	bit	remarks	power	origin	daisy_	ped	rev_le	write_date
	NULL	05HY028HLA008-04	05A807-TB POWER-18	16	BK	1N						220 VAC	05A550CB04		TSB		15.3.2004
	NULL	05HY028HLA008-CHASSIS	05W1F	16	WH							FRM GND			TSB		15.3.2004
	NULL	05HY028HLA009-01	05HY028HLA018-01	16	WH	1N						220VACN	05A550CB04		TSB		15.3.2004
	NULL	05HY028HLA009-03	05HY028HLA018-03	16	WH	1N						220VACN	05A550CB04		TSB		15.3.2004
	NULL	05HY028HLA009-04	05A807-TB POWER-20	16	BK	1N						220 VAC	05A550CB04		TSB		15.3.2004
	NULL	05HY028HLA009-CHASSIS	05W1F	16	WH							FRM GND			TSB		15.3.2004
	NULL	05HY028HLA010-04	05A807-TB POWER-22	16	BK	1N						220 VAC	05A550CB04		TSB		15.3.2004
	NULL	05HY028HLA010-CHASSIS	05W1F	16	WH							FRM GND			TSB		15.3.2004
	NULL	05HY028HLA011-01	05HY028HLA010-01	16	WH	1N						220VACN	05A550CB04		TSB		15.3.2004
	NULL	05HY028HLA011-03	05HY028HLA010-03	16	WH	1N						220VACN	05A550CB04		TSB		15.3.2004
	NULL	05HY028HLA011-04	05A807-TB POWER-24	16	BK	1N						220 VAC	05A550CB04		TSB		15.3.2004
	NULL	05HY028HLA011-CHASSIS	05W1F	16	WH							FRM GND			TSB		15.3.2004
	NULL	05HY028HLA012-01	05HY028HLA011-01	16	WH	1N						220VACN	05A550CB04		TSB		15.3.2004
	NULL	05HY028HLA012-03	05HY028HLA011-03	16	WH	1N						220VACN	05A550CB04		TSB		15.3.2004
	NULL	05HY028HLA012-04	05A807-TB POWER-26	16	BK	1N						220 VAC	05A550CB04		TSB		15.3.2004
	NULL	05HY028HLA012-CHASSIS	05W1F	16	WH							FRM GND			TSB		15.3.2004
	NULL	05HY028HLA013-01	05HY028HLA012-01	16	WH	1N						220VACN	05A550CB04		TSB		15.3.2004
	NULL	05HY028HLA013-03	05HY028HLA012-03	16	WH	1N						220VACN	05A550CB04		TSB		15.3.2004
	NULL	05HY028HLA013-04	05A807-TB POWER-28	16	BK	1N						220 VAC	05A550CB04		TSB		15.3.2004
	NULL	05HY028HLA013-CHASSIS	05W1F	16	WH							FRM GND			TSB		15.3.2004
	NULL	05HY028HLA014-01	05HY028HLA013-01	16	WH	1N						220VACN	05A550CB04		TSB		15.3.2004
	NULL	05HY028HLA014-03	05HY028HLA013-03	16	WH	1N						220VACN	05A550CB04		TSB		15.3.2004
	NULL	05HY028HLA014-04	05A807-TB POWER-30	16	BK	1N						220 VAC	05A550CB04		TSB		15.3.2004
	NULL	05HY028HLA014-CHASSIS	05W1F	16	WH							FRM GND			TSB		15.3.2004
	NULL	05HY028HLA015-01	05HY028HLA014-01	16	WH	1N						220VACN	05A550CB04		TSB		15.3.2004
	NULL	05HY028HLA015-03	05HY028HLA014-03	16	WH	1N						220VACN	05A550CB04		TSB		15.3.2004
	NULL	05HY028HLA015-04	05A807-TB POWER-32	16	BK	1N						220 VAC	05A550CB04		TSB		15.3.2004
	NULL	05HY028HLA015-CHASSIS	05W1F	16	WH							FRM GND			TSB		15.3.2004
	NULL	05HY028HLA016-01	05HY028HLA015-01	16	WH	1N						220VACN	05A550CB04		TSB		15.3.2004
	NULL	05HY028HLA016-03	05HY028HLA015-03	16	WH	1N						220VACN	05A550CB04		TSB		15.3.2004
	NULL	05HY028HLA016-04	05A808-TB POWER-02	16	BK	1N						220 VAC	05A550CB04		TSB		15.3.2004
	NULL	05HY028HLA016-CHASSIS	05W1F	16	WH							FRM GND			TSB		15.3.2004
	NULL	05HY028HLA017-01	05HY028HLA016-01	16	WH	1N						220VACN	05A550CB04		TSB		15.3.2004
	NULL	05HY028HLA017-03	05HY028HLA016-03	16	WH	1N						220VACN	05A550CB04		TSB		15.3.2004
	NULL	05HY028HLA017-04	05A808-TB POWER-04	16	BK	1N						220 VAC	05A550CB04		TSB		15.3.2004
	NULL	05HY028HLA017-CHASSIS	05W1F	16	WH							FRM GND			TSB		15.3.2004
	NULL	05HY028HLA018-01	05HY028HLA017-01	16	WH	1N						220VACN	05A550CB04		TSB		15.3.2004
	NULL	05HY028HLA018-03	05HY028HLA017-03	16	WH	1N						220VACN	05A550CB04		TSB		15.3.2004
	NULL	05HY028HLA018-04	05A808-TB POWER-06	16	BK	1N						220 VAC	05A550CB04		TSB		15.3.2004
	NULL	05HY028HLA018-CHASSIS	05W1F	16	WH							FRM GND			TSB		15.3.2004
	NULL	05A807-TB SIGNAL-04	05A530-A2P15-02	22	WH		LO	1	076	01	05HY028HLA001				TSB		15.3.2004
	NULL	05A807-TB SIGNAL-06	05A530-A2P15-03	22	WH		LO	1	076	02	05HY028HLA002				TSB		15.3.2004
	NULL	05A807-TB SIGNAL-08	05A530-A2P15-04	22	WH		LO	1	076	03	05HY028HLA003				TSB		15.3.2004
	NULL	05A807-TB SIGNAL-10	05A530-A2P15-05	22	WH		LO	1	076	04	05HY028HLA004				TSB		15.3.2004
	NULL	05A807-TB SIGNAL-12	05A530-A2P15-06	22	WH		LO	1	076	05	05HY028HLA005				TSB		15.3.2004
	NULL	05A807-TB SIGNAL-14	05A530-A2P15-07	22	WH		LO	1	076	06	05HY028HLA006				TSB		15.3.2004
	NULL	05A807-TB SIGNAL-16	05A530-A2P15-08	22	WH		LO	1	076	07	05HY028HLA007				TSB		15.3.2004
	NULL	05A807-TB SIGNAL-18	05A530-A2P15-09	22	WH		LO	1	076	08	05HY028HLA008				TSB		15.3.2004
	NULL	05A807-TB SIGNAL-20	05A530-A2P15-10	22	WH		LO	1	076	09	05HY028HLA009				TSB		15.3.2004
	NULL	05A807-TB SIGNAL-22	05A530-A2P15-11	22	WH		LO	1	076	10	05HY028HLA010				TSB		15.3.2004
	NULL	05A807-TB SIGNAL-24	05A530-A2P15-12	22	WH		LO	1	076	11	05HY028HLA011				TSB		15.3.2004
	NULL	05A807-TB SIGNAL-26	05A530-A2P15-13	22	WH		LO	1	076	12	05HY028HLA012				TSB		15.3.2004
	NULL	05A807-TB SIGNAL-28	05A530-A2P15-14	22	WH		LO	1	076	13	05HY028HLA013				TSB		15.3.2004
	NULL	05A807-TB SIGNAL-30	05A530-A2P15-15	22	WH		LO	1	076	14	05HY028HLA014				TSB		15.3.2004

coord	coord_	From	To	WC	CC	NC	IO	SC	Word	bit	remarks	power	origin	daisy_	ped	rev_le	write_date
	NULL	05A807-TB SIGNAL-32	05A530-A2P15-16	22	WH		LO	1	076	15	05HY028HLA015				TSB		15.3.2004
	NULL	05A808-TB SIGNAL-02	05A530-A2P16-01	22	WH		LO	1	077	00	05HY028HLA016				TSB		15.3.2004
	NULL	05A808-TB SIGNAL-04	05A530-A2P16-02	22	WH		LO	1	077	01	05HY028HLA017				TSB		15.3.2004
	NULL	05A808-TB SIGNAL-06	05A530-A2P16-03	22	WH		LO	1	077	02	05HY028HLA018				TSB		15.3.2004
HY29																	
6	NULL	06HY029HLA001-01	06A680-K12-NC	16	WH	1N						220VACN	06A550CB03		TSB	A	15.3.2004
	NULL	06HY029HLA001-01	06HY029HLA002-01	16	WH	1N						220VACN	06A550CB03		TSB		15.3.2004
6	NULL	06HY029HLA001-03	06A680-K07-NC	16	WH	1N						220VACN	06A550CB03		TSB	A	15.3.2004
	NULL	06HY029HLA001-03	06HY029HLA002-03	16	WH	1N						220VACN	06A550CB03		TSB		15.3.2004
	NULL	06HY029HLA001-04	06A800-TB POWER-02	16	BK	1N						220 VAC	06A550CB03		TSB		15.3.2004
	NULL	06HY029HLA001-CHASSIS	06W1B	16	WH							FRM GND			TSB		15.3.2004
	NULL	06HY029HLA002-01	06HY029HLA003-01	16	WH	1N						220VACN	06A550CB03		TSB		15.3.2004
	NULL	06HY029HLA002-03	06HY029HLA003-03	16	WH	1N						220VACN	06A550CB03		TSB		15.3.2004
	NULL	06HY029HLA002-04	06A800-TB POWER-04	16	BK	1N						220 VAC	06A550CB03		TSB		15.3.2004
	NULL	06HY029HLA002-CHASSIS	06W1B	16	WH							FRM GND			TSB		15.3.2004
	NULL	06HY029HLA003-01	06HY029HLA004-01	16	WH	1N						220VACN	06A550CB03		TSB		15.3.2004
	NULL	06HY029HLA003-03	06HY029HLA004-03	16	WH	1N						220VACN	06A550CB03		TSB		15.3.2004
	NULL	06HY029HLA003-04	06A800-TB POWER-06	16	BK	1N						220 VAC	06A550CB03		TSB		15.3.2004
	NULL	06HY029HLA003-CHASSIS	06W1B	16	WH							FRM GND			TSB		15.3.2004
	NULL	06HY029HLA004-01	06HY029HLA005-01	16	WH	1N						220VACN	06A550CB03		TSB		15.3.2004
	NULL	06HY029HLA004-03	06HY029HLA005-03	16	WH	1N						220VACN	06A550CB03		TSB		15.3.2004
	NULL	06HY029HLA004-04	06A800-TB POWER-08	16	BK	1N						220 VAC	06A550CB03		TSB		15.3.2004
	NULL	06HY029HLA004-CHASSIS	06W1B	16	WH							FRM GND			TSB		15.3.2004
	NULL	06HY029HLA005-01	06HY029HLA006-01	16	WH	1N						220VACN	06A550CB03		TSB		15.3.2004
	NULL	06HY029HLA005-03	06HY029HLA006-03	16	WH	1N						220VACN	06A550CB03		TSB		15.3.2004
	NULL	06HY029HLA005-04	06A800-TB POWER-10	16	BK	1N						220 VAC	06A550CB03		TSB		15.3.2004
	NULL	06HY029HLA005-CHASSIS	06W1B	16	WH							FRM GND			TSB		15.3.2004
	NULL	06HY029HLA006-01	06HY029HLA007-01	16	WH	1N						220VACN	06A550CB03		TSB		15.3.2004
	NULL	06HY029HLA006-03	06HY029HLA007-03	16	WH	1N						220VACN	06A550CB03		TSB		15.3.2004
	NULL	06HY029HLA006-04	06A800-TB POWER-12	16	BK	1N						220 VAC	06A550CB03		TSB		15.3.2004
	NULL	06HY029HLA006-CHASSIS	06W1B	16	WH							FRM GND			TSB		15.3.2004
	NULL	06HY029HLA007-01	06HY029HLA008-01	16	WH	1N						220VACN	06A550CB03		TSB		15.3.2004
	NULL	06HY029HLA007-03	06HY029HLA008-03	16	WH	1N						220VACN	06A550CB03		TSB		15.3.2004
	NULL	06HY029HLA007-04	06A800-TB POWER-14	16	BK	1N						220 VAC	06A550CB03		TSB		15.3.2004
	NULL	06HY029HLA007-CHASSIS	06W1B	16	WH							FRM GND			TSB		15.3.2004
	NULL	06HY029HLA008-01	06HY029HLA009-01	16	WH	1N						220VACN	06A550CB03		TSB		15.3.2004
	NULL	06HY029HLA008-03	06HY029HLA009-03	16	WH	1N						220VACN	06A550CB03		TSB		15.3.2004
	NULL	06HY029HLA008-04	06A800-TB POWER-16	16	BK	1N						220 VAC	06A550CB03		TSB		15.3.2004
	NULL	06HY029HLA008-CHASSIS	06W1B	16	WH							FRM GND			TSB		15.3.2004
	NULL	06HY029HLA009-01	06HY029HLA010-01	16	WH	1N						220VACN	06A550CB03		TSB		15.3.2004
	NULL	06HY029HLA009-03	06HY029HLA010-03	16	WH	1N						220VACN	06A550CB03		TSB		15.3.2004
	NULL	06HY029HLA009-04	06A800-TB POWER-18	16	BK	1N						220 VAC	06A550CB03		TSB		15.3.2004
	NULL	06HY029HLA009-CHASSIS	06W1B	16	WH							FRM GND			TSB		15.3.2004
	NULL	06HY029HLA010-01	06HY029HLA011-01	16	WH	1N						220VACN	06A550CB03		TSB		15.3.2004
	NULL	06HY029HLA010-03	06HY029HLA011-03	16	WH	1N						220VACN	06A550CB03		TSB		15.3.2004
	NULL	06HY029HLA010-04	06A800-TB POWER-20	16	BK	1N						220 VAC	06A550CB03		TSB		15.3.2004
	NULL	06HY029HLA010-CHASSIS	06W1B	16	WH							FRM GND			TSB		15.3.2004
	NULL	06HY029HLA011-01	06HY029HLA012-01	16	WH	1N						220VACN	06A550CB03		TSB		15.3.2004
	NULL	06HY029HLA011-03	06HY029HLA012-03	16	WH	1N						220VACN	06A550CB03		TSB		15.3.2004
	NULL	06HY029HLA011-04	06A800-TB POWER-22	16	BK	1N						220 VAC	06A550CB03		TSB		15.3.2004
	NULL	06HY029HLA011-CHASSIS	06W1B	16	WH							FRM GND			TSB		15.3.2004
	NULL	06HY029HLA012-01	06HY029HLA013-01	16	WH	1N						220VACN	06A550CB03		TSB		15.3.2004
	NULL	06HY029HLA012-03	06HY029HLA013-03	16	WH	1N						220VACN	06A550CB03		TSB		15.3.2004
	NULL	06HY029HLA012-04	06A800-TB POWER-24	16	BK	1N						220 VAC	06A550CB03		TSB		15.3.2004

coord	coord_	From	To	WC	CC	NC	IO	SC	Word	bit	remarks	power	origin	daisy_	ped	rev_le	write_date
	NULL	06HY029HLA012-CHASSIS	06W1B	16	WH							FRM GND			TSB		15.3.2004
	NULL	06HY029HLA013-01	06HY029HLA014-01	16	WH	1N						220VACN	06A550CB03		TSB		15.3.2004
	NULL	06HY029HLA013-03	06HY029HLA014-03	16	WH	1N						220VACN	06A550CB03		TSB		15.3.2004
	NULL	06HY029HLA013-04	06A800-TB POWER-26	16	BK	1N						220 VAC	06A550CB03		TSB		15.3.2004
	NULL	06HY029HLA013-CHASSIS	06W1B	16	WH							FRM GND			TSB		15.3.2004
	NULL	06HY029HLA014-01	06HY029HLA015-01	16	WH	1N						220VACN	06A550CB03		TSB		15.3.2004
	NULL	06HY029HLA014-03	06HY029HLA015-03	16	WH	1N						220VACN	06A550CB03		TSB		15.3.2004
	NULL	06HY029HLA014-04	06A800-TB POWER-28	16	BK	1N						220 VAC	06A550CB03		TSB		15.3.2004
	NULL	06HY029HLA014-CHASSIS	06W1B	16	WH							FRM GND			TSB		15.3.2004
	NULL	06HY029HLA015-01	06HY029HLA016-01	16	WH	1N						220VACN	06A550CB03		TSB		15.3.2004
	NULL	06HY029HLA015-03	06HY029HLA016-03	16	WH	1N						220VACN	06A550CB03		TSB		15.3.2004
	NULL	06HY029HLA015-04	06A800-TB POWER-30	16	BK	1N						220 VAC	06A550CB03		TSB		15.3.2004
	NULL	06HY029HLA015-CHASSIS	06W1B	16	WH							FRM GND			TSB		15.3.2004
	NULL	06HY029HLA016-01	06HY029HLA017-01	16	WH	1N						220VACN	06A550CB03		TSB		15.3.2004
	NULL	06HY029HLA016-03	06HY029HLA017-03	16	WH	1N						220VACN	06A550CB03		TSB		15.3.2004
	NULL	06HY029HLA016-04	06A800-TB POWER-32	16	BK	1N						220 VAC	06A550CB03		TSB		15.3.2004
	NULL	06HY029HLA016-CHASSIS	06W1B	16	WH							FRM GND			TSB		15.3.2004
	NULL	06HY029HLA017-01	06HY029HLA018-01	16	WH	1N						220VACN	06A550CB03		TSB		15.3.2004
	NULL	06HY029HLA017-03	06HY029HLA018-03	16	WH	1N						220VACN	06A550CB03		TSB		15.3.2004
	NULL	06HY029HLA017-04	06A801-TB POWER-02	16	BK	1N						220 VAC	06A550CB03		TSB		15.3.2004
	NULL	06HY029HLA017-CHASSIS	06W1B	16	WH							FRM GND			TSB		15.3.2004
	NULL	06HY029HLA018-04	06A801-TB POWER-04	16	BK	1N						220 VAC	06A550CB03		TSB		15.3.2004
	NULL	06HY029HLA018-CHASSIS	06W1B	16	WH							FRM GND			TSB		15.3.2004
	NULL	06A800-TB SIGNAL-02	06A530-A2P03-01	22	WH		LO	1	000	00	06HY029HLA001				TSB		15.3.2004
	NULL	06A800-TB SIGNAL-04	06A530-A2P03-02	22	WH		LO	1	000	01	06HY029HLA002				TSB		15.3.2004
	NULL	06A800-TB SIGNAL-06	06A530-A2P03-03	22	WH		LO	1	000	02	06HY029HLA003				TSB		15.3.2004
	NULL	06A800-TB SIGNAL-08	06A530-A2P03-04	22	WH		LO	1	000	03	06HY029HLA004				TSB		15.3.2004
	NULL	06A800-TB SIGNAL-10	06A530-A2P03-05	22	WH		LO	1	000	04	06HY029HLA005				TSB		15.3.2004
	NULL	06A800-TB SIGNAL-12	06A530-A2P03-06	22	WH		LO	1	000	05	06HY029HLA006				TSB		15.3.2004
	NULL	06A800-TB SIGNAL-14	06A530-A2P03-07	22	WH		LO	1	000	06	06HY029HLA007				TSB		15.3.2004
	NULL	06A800-TB SIGNAL-16	06A530-A2P03-08	22	WH		LO	1	000	07	06HY029HLA008				TSB		15.3.2004
	NULL	06A800-TB SIGNAL-18	06A530-A2P03-09	22	WH		LO	1	000	08	06HY029HLA009				TSB		15.3.2004
	NULL	06A800-TB SIGNAL-20	06A530-A2P03-10	22	WH		LO	1	000	09	06HY029HLA010				TSB		15.3.2004
	NULL	06A800-TB SIGNAL-22	06A530-A2P03-11	22	WH		LO	1	000	10	06HY029HLA011				TSB		15.3.2004
	NULL	06A800-TB SIGNAL-24	06A530-A2P03-12	22	WH		LO	1	000	11	06HY029HLA012				TSB		15.3.2004
	NULL	06A800-TB SIGNAL-26	06A530-A2P03-13	22	WH		LO	1	000	12	06HY029HLA013				TSB		15.3.2004
	NULL	06A800-TB SIGNAL-28	06A530-A2P03-14	22	WH		LO	1	000	13	06HY029HLA014				TSB		15.3.2004
	NULL	06A800-TB SIGNAL-30	06A530-A2P03-15	22	WH		LO	1	000	14	06HY029HLA015				TSB		15.3.2004
	NULL	06A800-TB SIGNAL-32	06A530-A2P03-16	22	WH		LO	1	000	15	06HY029HLA016				TSB		15.3.2004
	NULL	06A801-TB SIGNAL-02	06A530-A2P04-01	22	WH		LO	1	001	00	06HY029HLA017				TSB		15.3.2004
	NULL	06A801-TB SIGNAL-04	06A530-A2P04-02	22	WH		LO	1	001	01	06HY029HLA018				TSB		15.3.2004
HY30																	
	NULL	06HY030HLA001-01	06HY030HLA002-01	16	WH	1N						220VACN	06A550CB03		TSB		15.3.2004
	NULL	06HY030HLA001-03	06HY030HLA002-03	16	WH	1N						220VACN	06A550CB03		TSB		15.3.2004
	NULL	06HY030HLA001-04	06A801-TB POWER-06	16	BK	1N						220 VAC	06A550CB03		TSB		15.3.2004
	NULL	06HY030HLA001-CHASSIS	06W1B	16	WH							FRM GND			TSB		15.3.2004
	NULL	06HY030HLA002-01	06HY030HLA003-01	16	WH	1N						220VACN	06A550CB03		TSB		15.3.2004
	NULL	06HY030HLA002-03	06HY030HLA003-03	16	WH	1N						220VACN	06A550CB03		TSB		15.3.2004
	NULL	06HY030HLA002-04	06A801-TB POWER-08	16	BK	1N						220 VAC	06A550CB03		TSB		15.3.2004
	NULL	06HY030HLA002-CHASSIS	06W1B	16	WH							FRM GND			TSB		15.3.2004
	NULL	06HY030HLA003-01	06HY030HLA004-01	16	WH	1N						220VACN	06A550CB03		TSB		15.3.2004
	NULL	06HY030HLA003-03	06HY030HLA004-03	16	WH	1N						220VACN	06A550CB03		TSB		15.3.2004
	NULL	06HY030HLA003-04	06A801-TB POWER-10	16	BK	1N						220 VAC	06A550CB03		TSB		15.3.2004
	NULL	06HY030HLA003-CHASSIS	06W1B	16	WH							FRM GND			TSB		15.3.2004

coord	coord_	From	To	WC	CC	NC	IO	SC	Word	bit	remarks	power	origin	daisy_	ped	rev_le	write_date
	NULL	06HY030HLA004-01	06HY030HLA005-01	16	WH	1N						220VACN	06A550CB03		TSB		15.3.2004
	NULL	06HY030HLA004-03	06HY030HLA005-03	16	WH	1N						220VACN	06A550CB03		TSB		15.3.2004
	NULL	06HY030HLA004-04	06A801-TB POWER-12	16	BK	1N						220 VAC	06A550CB03		TSB		15.3.2004
	NULL	06HY030HLA004-CHASSIS	06W1B	16	WH							FRM GND			TSB		15.3.2004
	NULL	06HY030HLA005-01	06HY030HLA006-01	16	WH	1N						220VACN	06A550CB03		TSB		15.3.2004
	NULL	06HY030HLA005-03	06HY030HLA006-03	16	WH	1N						220VACN	06A550CB03		TSB		15.3.2004
	NULL	06HY030HLA005-04	06A801-TB POWER-14	16	BK	1N						220 VAC	06A550CB03		TSB		15.3.2004
	NULL	06HY030HLA005-CHASSIS	06W1B	16	WH							FRM GND			TSB		15.3.2004
	NULL	06HY030HLA006-01	06HY030HLA007-01	16	WH	1N						220VACN	06A550CB03		TSB		15.3.2004
	NULL	06HY030HLA006-03	06HY030HLA007-03	16	WH	1N						220VACN	06A550CB03		TSB		15.3.2004
	NULL	06HY030HLA006-04	06A801-TB POWER-16	16	BK	1N						220 VAC	06A550CB03		TSB		15.3.2004
	NULL	06HY030HLA006-CHASSIS	06W1B	16	WH							FRM GND			TSB		15.3.2004
	NULL	06HY030HLA007-01	06HY030HLA008-01	16	WH	1N						220VACN	06A550CB03		TSB		15.3.2004
	NULL	06HY030HLA007-03	06HY030HLA008-03	16	WH	1N						220VACN	06A550CB03		TSB		15.3.2004
	NULL	06HY030HLA007-04	06A801-TB POWER-18	16	BK	1N						220 VAC	06A550CB03		TSB		15.3.2004
	NULL	06HY030HLA007-CHASSIS	06W1C	16	WH							FRM GND			TSB		15.3.2004
	NULL	06HY030HLA008-01	06HY030HLA009-01	16	WH	1N						220VACN	06A550CB03		TSB		15.3.2004
	NULL	06HY030HLA008-03	06HY030HLA009-03	16	WH	1N						220VACN	06A550CB03		TSB		15.3.2004
	NULL	06HY030HLA008-04	06A801-TB POWER-20	16	BK	1N						220 VAC	06A550CB03		TSB		15.3.2004
	NULL	06HY030HLA008-CHASSIS	06W1C	16	WH							FRM GND			TSB		15.3.2004
	NULL	06HY030HLA009-01	06HY030HLA010-01	16	WH	1N						220VACN	06A550CB03		TSB		15.3.2004
	NULL	06HY030HLA009-03	06HY030HLA010-03	16	WH	1N						220VACN	06A550CB03		TSB		15.3.2004
	NULL	06HY030HLA009-04	06A801-TB POWER-22	16	BK	1N						220 VAC	06A550CB03		TSB		15.3.2004
	NULL	06HY030HLA009-CHASSIS	06W1C	16	WH							FRM GND			TSB		15.3.2004
	NULL	06HY030HLA010-01	06HY030HLA011-01	16	WH	1N						220VACN	06A550CB03		TSB		15.3.2004
	NULL	06HY030HLA010-03	06HY030HLA011-03	16	WH	1N						220VACN	06A550CB03		TSB		15.3.2004
	NULL	06HY030HLA010-04	06A801-TB POWER-24	16	BK	1N						220 VAC	06A550CB03		TSB		15.3.2004
	NULL	06HY030HLA010-CHASSIS	06W1C	16	WH							FRM GND			TSB		15.3.2004
	NULL	06HY030HLA011-01	06HY030HLA012-01	16	WH	1N						220VACN	06A550CB03		TSB		15.3.2004
	NULL	06HY030HLA011-03	06HY030HLA012-03	16	WH	1N						220VACN	06A550CB03		TSB		15.3.2004
	NULL	06HY030HLA011-04	06A801-TB POWER-26	16	BK	1N						220 VAC	06A550CB03		TSB		15.3.2004
	NULL	06HY030HLA011-CHASSIS	06W1C	16	WH							FRM GND			TSB		15.3.2004
	NULL	06HY030HLA012-01	06HY030HLA013-01	16	WH	1N						220VACN	06A550CB03		TSB		15.3.2004
	NULL	06HY030HLA012-03	06HY030HLA013-03	16	WH	1N						220VACN	06A550CB03		TSB		15.3.2004
	NULL	06HY030HLA012-04	06A801-TB POWER-28	16	BK	1N						220 VAC	06A550CB03		TSB		15.3.2004
	NULL	06HY030HLA012-CHASSIS	06W1C	16	WH							FRM GND			TSB		15.3.2004
	NULL	06HY030HLA013-01	06HY030HLA014-01	16	WH	1N						220VACN	06A550CB03		TSB		15.3.2004
	NULL	06HY030HLA013-03	06HY030HLA014-03	16	WH	1N						220VACN	06A550CB03		TSB		15.3.2004
	NULL	06HY030HLA013-04	06A801-TB POWER-30	16	BK	1N						220 VAC	06A550CB03		TSB		15.3.2004
	NULL	06HY030HLA013-CHASSIS	06W1C	16	WH							FRM GND			TSB		15.3.2004
	NULL	06HY030HLA014-01	06HY030HLA015-01	16	WH	1N						220VACN	06A550CB03		TSB		15.3.2004
	NULL	06HY030HLA014-03	06HY030HLA015-03	16	WH	1N						220VACN	06A550CB03		TSB		15.3.2004
	NULL	06HY030HLA014-04	06A801-TB POWER-32	16	BK	1N						220 VAC	06A550CB03		TSB		15.3.2004
	NULL	06HY030HLA014-CHASSIS	06W1C	16	WH							FRM GND			TSB		15.3.2004
	NULL	06HY030HLA015-01	06HY030HLA016-01	16	WH	1N						220VACN	06A550CB03		TSB		15.3.2004
	NULL	06HY030HLA015-03	06HY030HLA016-03	16	WH	1N						220VACN	06A550CB03		TSB		15.3.2004
	NULL	06HY030HLA015-04	06A802-TB POWER-02	16	BK	1N						220 VAC	06A550CB03		TSB		15.3.2004
	NULL	06HY030HLA015-CHASSIS	06W1C	16	WH							FRM GND			TSB		15.3.2004
	NULL	06HY030HLA016-01	06HY030HLA017-01	16	WH	1N						220VACN	06A550CB03		TSB		15.3.2004
	NULL	06HY030HLA016-03	06HY030HLA017-03	16	WH	1N						220VACN	06A550CB03		TSB		15.3.2004
	NULL	06HY030HLA016-04	06A802-TB POWER-04	16	BK	1N						220 VAC	06A550CB03		TSB		15.3.2004
	NULL	06HY030HLA016-CHASSIS	06W1C	16	WH							FRM GND			TSB		15.3.2004
	NULL	06HY030HLA017-01	06HY030HLA018-01	16	WH	1N						220VACN	06A550CB03		TSB		15.3.2004
	NULL	06HY030HLA017-03	06HY030HLA018-03	16	WH	1N						220VACN	06A550CB03		TSB		15.3.2004

coord	coord_	From	To	WC	CC	NC	IO	SC	Word	bit	remarks	power	origin	daisy_	ped	rev_le	write_date
	NULL	06HY030HLA017-04	06A802-TB POWER-06	16	BK	1N						220 VAC	06A550CB03		TSB		15.3.2004
	NULL	06HY030HLA017-CHASSIS	06W1C	16	WH							FRM GND			TSB		15.3.2004
	NULL	06HY030HLA018-01	06A680-K13-NC	16	WH	1N						220VACN	06A550CB03		TSB	A	15.3.2004
	NULL	06HY030HLA018-03	06A680-K08-NC	16	WH	1N						220VACN	06A550CB03		TSB	A	15.3.2004
	NULL	06HY030HLA018-04	06A802-TB POWER-08	16	BK	1N						220 VAC	06A550CB03		TSB		15.3.2004
	NULL	06HY030HLA018-CHASSIS	06W1C	16	WH							FRM GND			TSB		15.3.2004
	NULL	06A801-TB SIGNAL-06	06A530-A2P04-03	22	WH		LO	1	001	02	06HY030HLA001				TSB		15.3.2004
	NULL	06A801-TB SIGNAL-08	06A530-A2P04-04	22	WH		LO	1	001	03	06HY030HLA002				TSB		15.3.2004
	NULL	06A801-TB SIGNAL-10	06A530-A2P04-05	22	WH		LO	1	001	04	06HY030HLA003				TSB		15.3.2004
	NULL	06A801-TB SIGNAL-12	06A530-A2P04-06	22	WH		LO	1	001	05	06HY030HLA004				TSB		15.3.2004
	NULL	06A801-TB SIGNAL-14	06A530-A2P04-07	22	WH		LO	1	001	06	06HY030HLA005				TSB		15.3.2004
	NULL	06A801-TB SIGNAL-16	06A530-A2P04-08	22	WH		LO	1	001	07	06HY030HLA006				TSB		15.3.2004
	NULL	06A801-TB SIGNAL-18	06A530-A2P04-09	22	WH		LO	1	001	08	06HY030HLA007				TSB		15.3.2004
	NULL	06A801-TB SIGNAL-20	06A530-A2P04-10	22	WH		LO	1	001	09	06HY030HLA008				TSB		15.3.2004
	NULL	06A801-TB SIGNAL-22	06A530-A2P04-11	22	WH		LO	1	001	10	06HY030HLA009				TSB		15.3.2004
	NULL	06A801-TB SIGNAL-24	06A530-A2P04-12	22	WH		LO	1	001	11	06HY030HLA010				TSB		15.3.2004
	NULL	06A801-TB SIGNAL-26	06A530-A2P04-13	22	WH		LO	1	001	12	06HY030HLA011				TSB		15.3.2004
	NULL	06A801-TB SIGNAL-28	06A530-A2P04-14	22	WH		LO	1	001	13	06HY030HLA012				TSB		15.3.2004
	NULL	06A801-TB SIGNAL-30	06A530-A2P04-15	22	WH		LO	1	001	14	06HY030HLA013				TSB		15.3.2004
	NULL	06A801-TB SIGNAL-32	06A530-A2P04-16	22	WH		LO	1	001	15	06HY030HLA014				TSB		15.3.2004
	NULL	06A802-TB SIGNAL-02	06A530-A2P05-01	22	WH		LO	1	002	00	06HY030HLA015				TSB		15.3.2004
	NULL	06A802-TB SIGNAL-04	06A530-A2P05-02	22	WH		LO	1	002	01	06HY030HLA016				TSB		15.3.2004
	NULL	06A802-TB SIGNAL-06	06A530-A2P05-03	22	WH		LO	1	002	02	06HY030HLA017				TSB		15.3.2004
	NULL	06A802-TB SIGNAL-08	06A530-A2P05-04	22	WH		LO	1	002	03	06HY030HLA018				TSB		15.3.2004
HY31																	
	NULL	06HY031HLA001-01	06HY031HLA002-01	16	WH	1N						220VACN	06A550CB03		TSB		15.3.2004
	NULL	06HY031HLA001-03	06HY031HLA002-03	16	WH	1N						220VACN	06A550CB03		TSB		15.3.2004
	NULL	06HY031HLA001-04	06A802-TB POWER-10	16	BK	1N						220 VAC	06A550CB03		TSB		15.3.2004
	NULL	06HY031HLA001-CHASSIS	06W1C	16	WH							FRM GND			TSB		15.3.2004
	NULL	06HY031HLA002-01	06HY031HLA003-01	16	WH	1N						220VACN	06A550CB03		TSB		15.3.2004
	NULL	06HY031HLA002-03	06HY031HLA003-03	16	WH	1N						220VACN	06A550CB03		TSB		15.3.2004
	NULL	06HY031HLA002-04	06A802-TB POWER-12	16	BK	1N						220 VAC	06A550CB03		TSB		15.3.2004
	NULL	06HY031HLA002-CHASSIS	06W1C	16	WH							FRM GND			TSB		15.3.2004
	NULL	06HY031HLA003-01	06HY031HLA004-01	16	WH	1N						220VACN	06A550CB03		TSB		15.3.2004
	NULL	06HY031HLA003-03	06HY031HLA004-03	16	WH	1N						220VACN	06A550CB03		TSB		15.3.2004
	NULL	06HY031HLA003-04	06A802-TB POWER-14	16	BK	1N						220 VAC	06A550CB03		TSB		15.3.2004
	NULL	06HY031HLA003-CHASSIS	06W1C	16	WH							FRM GND			TSB		15.3.2004
	NULL	06HY031HLA004-01	06HY031HLA005-01	16	WH	1N						220VACN	06A550CB03		TSB		15.3.2004
	NULL	06HY031HLA004-03	06HY031HLA005-03	16	WH	1N						220VACN	06A550CB03		TSB		15.3.2004
	NULL	06HY031HLA004-04	06A802-TB POWER-16	16	BK	1N						220 VAC	06A550CB03		TSB		15.3.2004
	NULL	06HY031HLA004-CHASSIS	06W1C	16	WH							FRM GND			TSB		15.3.2004
	NULL	06HY031HLA005-01	06HY031HLA006-01	16	WH	1N						220VACN	06A550CB03		TSB		15.3.2004
	NULL	06HY031HLA005-03	06HY031HLA006-03	16	WH	1N						220VACN	06A550CB03		TSB		15.3.2004
	NULL	06HY031HLA005-04	06A802-TB POWER-18	16	BK	1N						220 VAC	06A550CB03		TSB		15.3.2004
	NULL	06HY031HLA005-CHASSIS	06W1C	16	WH							FRM GND			TSB		15.3.2004
	NULL	06HY031HLA006-01	06HY031HLA007-01	16	WH	1N						220VACN	06A550CB03		TSB		15.3.2004
	NULL	06HY031HLA006-03	06HY031HLA007-03	16	WH	1N						220VACN	06A550CB03		TSB		15.3.2004
	NULL	06HY031HLA006-04	06A802-TB POWER-20	16	BK	1N						220 VAC	06A550CB03		TSB		15.3.2004
	NULL	06HY031HLA006-CHASSIS	06W1C	16	WH							FRM GND			TSB		15.3.2004
	NULL	06HY031HLA007-01	06HY031HLA008-01	16	WH	1N						220VACN	06A550CB03		TSB		15.3.2004
	NULL	06HY031HLA007-03	06HY031HLA008-03	16	WH	1N						220VACN	06A550CB03		TSB		15.3.2004
	NULL	06HY031HLA007-04	06A802-TB POWER-22	16	BK	1N						220 VAC	06A550CB03		TSB		15.3.2004
	NULL	06HY031HLA007-CHASSIS	06W1C	16	WH							FRM GND			TSB		15.3.2004
	NULL	06HY031HLA008-01	06HY031HLA009-01	16	WH	1N						220VACN	06A550CB03		TSB		15.3.2004

coord	coord_	From	To	WC	CC	NC	IO	SC	Word	bit	remarks	power	origin	daisy_	ped	rev_le	write_date
	NULL	06HY031HLA008-03	06HY031HLA009-03	16	WH	1N						220VACN	06A550CB03		TSB		15.3.2004
	NULL	06HY031HLA008-04	06A802-TB POWER-24	16	BK	1N						220 VAC	06A550CB03		TSB		15.3.2004
	NULL	06HY031HLA008-CHASSIS	06W1C	16	WH							FRM GND			TSB		15.3.2004
	NULL	06HY031HLA009-01	06HY031HLA010-01	16	WH	1N						220VACN	06A550CB03		TSB		15.3.2004
	NULL	06HY031HLA009-03	06HY031HLA010-03	16	WH	1N						220VACN	06A550CB03		TSB		15.3.2004
	NULL	06HY031HLA009-04	06A802-TB POWER-26	16	BK	1N						220 VAC	06A550CB03		TSB		15.3.2004
	NULL	06HY031HLA009-CHASSIS	06W1C	16	WH							FRM GND			TSB		15.3.2004
	NULL	06HY031HLA010-01	06HY031HLA011-01	16	WH	1N						220VACN	06A550CB03		TSB		15.3.2004
	NULL	06HY031HLA010-03	06HY031HLA011-03	16	WH	1N						220VACN	06A550CB03		TSB		15.3.2004
	NULL	06HY031HLA010-04	06A802-TB POWER-28	16	BK	1N						220 VAC	06A550CB03		TSB		15.3.2004
	NULL	06HY031HLA010-CHASSIS	06W1C	16	WH							FRM GND			TSB		15.3.2004
	NULL	06HY031HLA011-01	06HY031HLA012-01	16	WH	1N						220VACN	06A550CB03		TSB		15.3.2004
	NULL	06HY031HLA011-03	06HY031HLA012-03	16	WH	1N						220VACN	06A550CB03		TSB		15.3.2004
	NULL	06HY031HLA011-04	06A802-TB POWER-30	16	BK	1N						220 VAC	06A550CB03		TSB		15.3.2004
	NULL	06HY031HLA011-CHASSIS	06W1C	16	WH							FRM GND			TSB		15.3.2004
	NULL	06HY031HLA012-01	06HY031HLA013-01	16	WH	1N						220VACN	06A550CB03		TSB		15.3.2004
	NULL	06HY031HLA012-03	06HY031HLA013-03	16	WH	1N						220VACN	06A550CB03		TSB		15.3.2004
	NULL	06HY031HLA012-04	06A802-TB POWER-32	16	BK	1N						220 VAC	06A550CB03		TSB		15.3.2004
	NULL	06HY031HLA012-CHASSIS	06W1C	16	WH							FRM GND			TSB		15.3.2004
	NULL	06HY031HLA013-01	06HY031HLA014-01	16	WH	1N						220VACN	06A550CB03		TSB		15.3.2004
	NULL	06HY031HLA013-03	06HY031HLA014-03	16	WH	1N						220VACN	06A550CB03		TSB		15.3.2004
	NULL	06HY031HLA013-04	06A803-TB POWER-02	16	BK	1N						220 VAC	06A550CB03		TSB		15.3.2004
	NULL	06HY031HLA013-CHASSIS	06W1D	16	WH							FRM GND			TSB		15.3.2004
	NULL	06HY031HLA014-01	06HY031HLA015-01	16	WH	1N						220VACN	06A550CB03		TSB		15.3.2004
	NULL	06HY031HLA014-03	06HY031HLA015-03	16	WH	1N						220VACN	06A550CB03		TSB		15.3.2004
	NULL	06HY031HLA014-04	06A803-TB POWER-04	16	BK	1N						220 VAC	06A550CB03		TSB		15.3.2004
	NULL	06HY031HLA014-CHASSIS	06W1D	16	WH							FRM GND			TSB		15.3.2004
	NULL	06HY031HLA015-01	06HY031HLA016-01	16	WH	1N						220VACN	06A550CB03		TSB		15.3.2004
	NULL	06HY031HLA015-03	06HY031HLA016-03	16	WH	1N						220VACN	06A550CB03		TSB		15.3.2004
	NULL	06HY031HLA015-04	06A803-TB POWER-06	16	BK	1N						220 VAC	06A550CB03		TSB		15.3.2004
	NULL	06HY031HLA015-CHASSIS	06W1D	16	WH							FRM GND			TSB		15.3.2004
	NULL	06HY031HLA016-01	06HY031HLA017-01	16	WH	1N						220VACN	06A550CB03		TSB		15.3.2004
	NULL	06HY031HLA016-03	06HY031HLA017-03	16	WH	1N						220VACN	06A550CB03		TSB		15.3.2004
	NULL	06HY031HLA016-04	06A803-TB POWER-08	16	BK	1N						220 VAC	06A550CB03		TSB		15.3.2004
	NULL	06HY031HLA016-CHASSIS	06W1D	16	WH							FRM GND			TSB		15.3.2004
	NULL	06HY031HLA017-01	06HY031HLA018-01	16	WH	1N						220VACN	06A550CB03		TSB		15.3.2004
	NULL	06HY031HLA017-03	06HY031HLA018-03	16	WH	1N						220VACN	06A550CB03		TSB		15.3.2004
	NULL	06HY031HLA017-04	06A803-TB POWER-10	16	BK	1N						220 VAC	06A550CB03		TSB		15.3.2004
	NULL	06HY031HLA017-CHASSIS	06W1D	16	WH							FRM GND			TSB		15.3.2004
	NULL	06HY031HLA018-01	06A680-K14-NC	16	WH	1N						220VACN	06A550CB03		TSB	A	15.3.2004
	NULL	06HY031HLA018-03	06A680-K09-NC	16	WH	1N						220VACN	06A550CB03		TSB	A	15.3.2004
	NULL	06HY031HLA018-04	06A803-TB POWER-12	16	BK	1N						220 VAC	06A550CB03		TSB		15.3.2004
	NULL	06HY031HLA018-CHASSIS	06W1D	16	WH							FRM GND			TSB		15.3.2004
6	NULL	06HY031HLA019-01	06HY031HLA020-01	16	WH	1N						220VACN	06A550CB10		TSB		15.3.2004
6	NULL	06HY031HLA019-03	06HY031HLA020-03	16	WH	1N						220VACN	06A550CB10		TSB		15.3.2004
6	NULL	06HY031HLA019-04	06A810-TB POWER-02	16	BK	1N						220VAC	06A550CB10		TSB		15.3.2004
6	NULL	06HY031HLA019-CHASSIS	06W1H	16		WH						FRM GND			TSB		15.3.2004
	NULL	06HY031HLA020-01	06HY031HLA021-01	16	WH	1N						220VACN	06A550CB10		TSB		15.3.2004
	NULL	06HY031HLA020-03	06HY031HLA021-03	16	WH	1N						220VACN	06A550CB10		TSB		15.3.2004
	NULL	06HY031HLA020-04	06A810-TB POWER-04	16	BK	1N						220 VAC	06A550CB10		TSB		15.3.2004
	NULL	06HY031HLA020-CHASSIS	06W1H	16	WH							FRM GND			TSB		15.3.2004
	NULL	06HY031HLA021-01	06HY031HLA022-01	16	WH	1N						220VACN	06A550CB10		TSB		15.3.2004
	NULL	06HY031HLA021-03	06HY031HLA022-03	16	WH	1N						220VACN	06A550CB10		TSB		15.3.2004
	NULL	06HY031HLA021-04	06A810-TB POWER-06	16	BK	1N						220 VAC	06A550CB10		TSB		15.3.2004

coord	coord_	From	To	WC	CC	NC	IO	SC	Word	bit	remarks	power	origin	daisy_	ped	rev_le	write_date
	NULL	06HY031HLA021-CHASSIS	06W1H	16	WH							FRM GND			TSB		15.3.2004
	NULL	06HY031HLA022-01	06HY031HLA023-01	16	WH	1N						220VACN	06A550CB10		TSB		15.3.2004
	NULL	06HY031HLA022-03	06HY031HLA023-03	16	WH	1N						220VACN	06A550CB10		TSB		15.3.2004
	NULL	06HY031HLA022-04	06A810-TB POWER-08	16	BK	1N						220 VAC	06A550CB10		TSB		15.3.2004
	NULL	06HY031HLA022-CHASSIS	06W1H	16	WH							FRM GND			TSB		15.3.2004
	NULL	06HY031HLA023-01	06HY031HLA024-01	16	WH	1N						220VACN	06A550CB10		TSB		15.3.2004
	NULL	06HY031HLA023-03	06HY031HLA024-03	16	WH	1N						220VACN	06A550CB10		TSB		15.3.2004
	NULL	06HY031HLA023-04	06A810-TB POWER-10	16	BK	1N						220 VAC	06A550CB10		TSB		15.3.2004
	NULL	06HY031HLA023-CHASSIS	06W1H	16	WH							FRM GND			TSB		15.3.2004
	NULL	06HY031HLA024-01	06HY031HLA025-01	16	WH	1N						220VACN	06A550CB10		TSB		15.3.2004
	NULL	06HY031HLA024-03	06HY031HLA025-03	16	WH	1N						220VACN	06A550CB10		TSB		15.3.2004
	NULL	06HY031HLA024-04	06A810-TB POWER-12	16	BK	1N						220 VAC	06A550CB10		TSB		15.3.2004
	NULL	06HY031HLA024-CHASSIS	06W1H	16	WH							FRM GND			TSB		15.3.2004
	NULL	06HY031HLA025-01	06HY031HLA026-01	16	WH	1N						220VACN	06A550CB10		TSB		15.3.2004
	NULL	06HY031HLA025-03	06HY031HLA026-03	16	WH	1N						220VACN	06A550CB10		TSB		15.3.2004
	NULL	06HY031HLA025-04	06A810-TB POWER-14	16	BK	1N						220 VAC	06A550CB10		TSB		15.3.2004
	NULL	06HY031HLA025-CHASSIS	06W1H	16	WH							FRM GND			TSB		15.3.2004
	NULL	06HY031HLA026-01	06HY031HLA027-01	16	WH	1N						220VACN	06A550CB10		TSB		15.3.2004
	NULL	06HY031HLA026-03	06HY031HLA027-03	16	WH	1N						220VACN	06A550CB10		TSB		15.3.2004
	NULL	06HY031HLA026-04	06A810-TB POWER-16	16	BK	1N						220 VAC	06A550CB10		TSB		15.3.2004
	NULL	06HY031HLA026-CHASSIS	06W1H	16	WH							FRM GND			TSB		15.3.2004
	NULL	06HY031HLA027-01	06HY031HLA036-01	16	WH	1N						220VACN	06A550CB10		TSB		15.3.2004
	NULL	06HY031HLA027-03	06HY031HLA036-03	16	WH	1N						220VACN	06A550CB10		TSB		15.3.2004
	NULL	06HY031HLA027-04	06A810-TB POWER-18	16	BK	1N						220 VAC	06A550CB10		TSB		15.3.2004
	NULL	06HY031HLA027-CHASSIS	06W1H	16	WH							FRM GND			TSB		15.3.2004
	NULL	06HY031HLA028-01	06HY031HLA037-01	16	WH	1N						220VACN	06A550CB10		TSB		15.3.2004
	NULL	06HY031HLA028-03	06HY031HLA037-03	16	WH	1N						220VACN	06A550CB10		TSB		15.3.2004
	NULL	06HY031HLA028-04	06A810-TB POWER-20	16	BK	1N						220 VAC	06A550CB10		TSB		15.3.2004
	NULL	06HY031HLA028-CHASSIS	06W1H	16	WH							FRM GND			TSB		15.3.2004
	NULL	06HY031HLA029-01	06HY031HLA028-01	16	WH	1N						220VACN	06A550CB10		TSB		15.3.2004
	NULL	06HY031HLA029-03	06HY031HLA028-03	16	WH	1N						220VACN	06A550CB10		TSB		15.3.2004
	NULL	06HY031HLA029-04	06A810-TB POWER-22	16	BK	1N						220 VAC	06A550CB10		TSB		15.3.2004
	NULL	06HY031HLA029-CHASSIS	06W1H	16	WH							FRM GND			TSB		15.3.2004
	NULL	06HY031HLA030-01	06HY031HLA029-01	16	WH	1N						220VACN	06A550CB10		TSB		15.3.2004
	NULL	06HY031HLA030-03	06HY031HLA029-03	16	WH	1N						220VACN	06A550CB10		TSB		15.3.2004
	NULL	06HY031HLA030-04	06A810-TB POWER-24	16	BK	1N						220 VAC	06A550CB10		TSB		15.3.2004
	NULL	06HY031HLA030-CHASSIS	06W1H	16	WH							FRM GND			TSB		15.3.2004
	NULL	06HY031HLA031-01	06HY031HLA030-01	16	WH	1N						220VACN	06A550CB10		TSB		15.3.2004
	NULL	06HY031HLA031-03	06HY031HLA030-03	16	WH	1N						220VACN	06A550CB10		TSB		15.3.2004
	NULL	06HY031HLA031-04	06A810-TB POWER-26	16	BK	1N						220 VAC	06A550CB10		TSB		15.3.2004
	NULL	06HY031HLA031-CHASSIS	06W1H	16	WH							FRM GND			TSB		15.3.2004
	NULL	06HY031HLA032-01	06HY031HLA031-01	16	WH	1N						220VACN	06A550CB10		TSB		15.3.2004
	NULL	06HY031HLA032-03	06HY031HLA031-03	16	WH	1N						220VACN	06A550CB10		TSB		15.3.2004
	NULL	06HY031HLA032-04	06A810-TB POWER-28	16	BK	1N						220 VAC	06A550CB10		TSB		15.3.2004
	NULL	06HY031HLA032-CHASSIS	06W1H	16	WH							FRM GND			TSB		15.3.2004
	NULL	06HY031HLA033-01	06HY031HLA032-01	16	WH	1N						220VACN	06A550CB10		TSB		15.3.2004
	NULL	06HY031HLA033-03	06HY031HLA032-03	16	WH	1N						220VACN	06A550CB10		TSB		15.3.2004
	NULL	06HY031HLA033-04	06A810-TB POWER-30	16	BK	1N						220 VAC	06A550CB10		TSB		15.3.2004
	NULL	06HY031HLA033-CHASSIS	06W1H	16	WH							FRM GND			TSB		15.3.2004
	NULL	06HY031HLA034-01	06HY031HLA033-01	16	WH	1N						220VACN	06A550CB10		TSB		15.3.2004
	NULL	06HY031HLA034-03	06HY031HLA033-03	16	WH	1N						220VACN	06A550CB10		TSB		15.3.2004
	NULL	06HY031HLA034-04	06A810-TB POWER-32	16	BK	1N						220 VAC	06A550CB10		TSB		15.3.2004
	NULL	06HY031HLA034-CHASSIS	06W1H	16	WH							FRM GND			TSB		15.3.2004
	NULL	06HY031HLA035-01	06HY031HLA034-01	16	WH	1N						220VACN	06A550CB10		TSB		15.3.2004

coord	coord_	From	To	WC	CC	NC	IO	SC	Word	bit	remarks	power	origin	daisy_	ped	rev_le	write_date
	NULL	06HY031HLA035-03	06HY031HLA034-03	16	WH	1N						220VACN	06A550CB10		TSB		15.3.2004
	NULL	06HY031HLA035-04	06A811-TB POWER-02	16	BK	1N						220 VAC	06A550CB10		TSB		15.3.2004
	NULL	06HY031HLA035-CHASSIS	06W1H	16	WH							FRM GND			TSB		15.3.2004
	NULL	06HY031HLA036-01	06HY031HLA035-01	16	WH	1N						220VACN	06A550CB10		TSB		15.3.2004
	NULL	06HY031HLA036-03	06HY031HLA035-03	16	WH	1N						220VACN	06A550CB10		TSB		15.3.2004
	NULL	06HY031HLA036-04	06A811-TB POWER-04	16	BK	1N						220 VAC	06A550CB10		TSB		15.3.2004
	NULL	06HY031HLA036-CHASSIS	06W1H	16	WH							FRM GND			TSB		15.3.2004
	NULL	06HY031HLA037-01	06HY031HLA038-01	16	WH	1N						220VACN	06A550CB10		TSB		15.3.2004
	NULL	06HY031HLA037-03	06HY031HLA038-03	16	WH	1N						220VACN	06A550CB10		TSB		15.3.2004
	NULL	06HY031HLA037-04	06A811-TB POWER-06	16	BK	1N						220 VAC	06A550CB10		TSB		15.3.2004
	NULL	06HY031HLA037-CHASSIS	06W1H	16	WH							FRM GND			TSB		15.3.2004
	NULL	06HY031HLA038-01	06HY031HLA039-01	16	WH	1N						220VACN	06A550CB10		TSB		15.3.2004
	NULL	06HY031HLA038-03	06HY031HLA039-03	16	WH	1N						220VACN	06A550CB10		TSB		15.3.2004
	NULL	06HY031HLA038-04	06A811-TB POWER-08	16	BK	1N						220 VAC	06A550CB10		TSB		15.3.2004
	NULL	06HY031HLA038-CHASSIS	06W1H	16	WH							FRM GND			TSB		15.3.2004
	NULL	06HY031HLA039-01	06HY031HLA040-01	16	WH	1N						220VACN	06A550CB10		TSB		15.3.2004
	NULL	06HY031HLA039-03	06HY031HLA040-03	16	WH	1N						220VACN	06A550CB10		TSB		15.3.2004
	NULL	06HY031HLA039-04	06A811-TB POWER-10	16	BK	1N						220 VAC	06A550CB10		TSB		15.3.2004
	NULL	06HY031HLA039-CHASSIS	06W1H	16	WH							FRM GND			TSB		15.3.2004
	NULL	06HY031HLA040-01	06HY031HLA041-01	16	WH	1N						220VACN	06A550CB10		TSB		15.3.2004
	NULL	06HY031HLA040-03	06HY031HLA041-03	16	WH	1N						220VACN	06A550CB10		TSB		15.3.2004
	NULL	06HY031HLA040-04	06A811-TB POWER-12	16	BK	1N						220 VAC	06A550CB10		TSB		15.3.2004
	NULL	06HY031HLA040-CHASSIS	06W1H	16	WH							FRM GND			TSB		15.3.2004
	NULL	06HY031HLA041-01	06HY031HLA042-01	16	WH	1N						220VACN	06A550CB10		TSB		15.3.2004
	NULL	06HY031HLA041-03	06HY031HLA042-03	16	WH	1N						220VACN	06A550CB10		TSB		15.3.2004
	NULL	06HY031HLA041-04	06A811-TB POWER-14	16	BK	1N						220 VAC	06A550CB10		TSB		15.3.2004
	NULL	06HY031HLA041-CHASSIS	06W1H	16	WH							FRM GND			TSB		15.3.2004
	NULL	06HY031HLA042-01	06HY031HLA043-01	16	WH	1N						220VACN	06A550CB10		TSB		15.3.2004
	NULL	06HY031HLA042-03	06HY031HLA043-03	16	WH	1N						220VACN	06A550CB10		TSB		15.3.2004
	NULL	06HY031HLA042-04	06A811-TB POWER-16	16	BK	1N						220 VAC	06A550CB10		TSB		15.3.2004
	NULL	06HY031HLA042-CHASSIS	06W1H	16	WH							FRM GND			TSB		15.3.2004
	NULL	06HY031HLA043-01	06HY031HLA044-01	16	WH	1N						220VACN	06A550CB10		TSB		15.3.2004
	NULL	06HY031HLA043-03	06HY031HLA044-03	16	WH	1N						220VACN	06A550CB10		TSB		15.3.2004
	NULL	06HY031HLA043-04	06A811-TB POWER-18	16	BK	1N						220 VAC	06A550CB10		TSB		15.3.2004
	NULL	06HY031HLA043-CHASSIS	06W1H	16	WH							FRM GND			TSB		15.3.2004
	NULL	06HY031HLA044-01	06HY031HLA045-01	16	WH	1N						220VACN	06A550CB10		TSB		15.3.2004
	NULL	06HY031HLA044-03	06HY031HLA045-03	16	WH	1N						220VACN	06A550CB10		TSB		15.3.2004
	NULL	06HY031HLA044-04	06A811-TB POWER-20	16	BK	1N						220 VAC	06A550CB10		TSB		15.3.2004
	NULL	06HY031HLA044-CHASSIS	06W1H	16	WH							FRM GND			TSB		15.3.2004
	NULL	06HY031HLA045-01	06HY031HLA054-01	16	WH	1N						220VACN	06A550CB10		TSB		15.3.2004
	NULL	06HY031HLA045-03	06HY031HLA054-03	16	WH	1N						220VACN	06A550CB10		TSB		15.3.2004
	NULL	06HY031HLA045-04	06A811-TB POWER-22	16	BK	1N						220 VAC	06A550CB10		TSB		15.3.2004
	NULL	06HY031HLA045-CHASSIS	06W1H	16	WH							FRM GND			TSB		15.3.2004
	NULL	06HY031HLA046-01	06A681-K06-05	16	WH	1N						220VACN	06A550CB10		TSB		15.3.2004
	NULL	06HY031HLA046-03	06A681-K05-05	16	WH	1N						220VACN	06A550CB10		TSB		15.3.2004
	NULL	06HY031HLA046-04	06A811-TB POWER-24	16	BK	1N						220 VAC	06A550CB10		TSB		15.3.2004
	NULL	06HY031HLA046-CHASSIS	06W1H	16	WH							FRM GND			TSB		15.3.2004
	NULL	06HY031HLA047-01	06HY031HLA046-01	16	WH	1N						220VACN	06A550CB10		TSB		15.3.2004
	NULL	06HY031HLA047-03	06HY031HLA046-03	16	WH	1N						220VACN	06A550CB10		TSB		15.3.2004
	NULL	06HY031HLA047-04	06A811-TB POWER-26	16	BK	1N						220 VAC	06A550CB10		TSB		15.3.2004
	NULL	06HY031HLA047-CHASSIS	06W1H	16	WH							FRM GND			TSB		15.3.2004
	NULL	06HY031HLA048-01	06HY031HLA047-01	16	WH	1N						220VACN	06A550CB10		TSB		15.3.2004
	NULL	06HY031HLA048-03	06HY031HLA047-03	16	WH	1N						220VACN	06A550CB10		TSB		15.3.2004
	NULL	06HY031HLA048-04	06A811-TB POWER-28	16	BK	1N						220 VAC	06A550CB10		TSB		15.3.2004

coord	coord_	From	To	WC	CC	NC	IO	SC	Word	bit	remarks	power	origin	daisy_	ped	rev_le	write_date
	NULL	06HY031HLA048-CHASSIS	06W1H	16	WH							FRM GND			TSB		15.3.2004
	NULL	06HY031HLA049-03	06HY031HLA048-03	16	WH	1N						220VACN	06A550CB10		TSB		15.3.2004
	NULL	06HY031HLA049-04	06A811-TB POWER-30	16	BK	1N						220 VAC	06A550CB10		TSB		15.3.2004
	NULL	06HY031HLA049-CHASSIS	06W1H	16	WH							FRM GND			TSB		15.3.2004
	NULL	06HY031HLA050-01	06HY031HLA049-01	16	WH	1N						220VACN	06A550CB10		TSB		15.3.2004
	NULL	06HY031HLA050-03	06HY031HLA049-03	16	WH	1N						220VACN	06A550CB10		TSB		15.3.2004
	NULL	06HY031HLA050-04	06A811-TB POWER-32	16	BK	1N						220 VAC	06A550CB10		TSB		15.3.2004
	NULL	06HY031HLA050-CHASSIS	06W1H	16	WH							FRM GND			TSB		15.3.2004
	NULL	06HY031HLA051-01	06HY031HLA050-01	16	WH	1N						220VACN	06A550CB10		TSB		15.3.2004
	NULL	06HY031HLA051-04	06A809-TB POWER-04	16	BK	1N						220 VAC	06A550CB10		TSB		15.3.2004
	NULL	06HY031HLA051-CHASSIS	06W1H	16	WH							FRM GND			TSB		15.3.2004
	NULL	06HY031HLA052-01	06HY031HLA051-01	16	WH	1N						220VACN	06A550CB10		TSB		15.3.2004
	NULL	06HY031HLA052-03	06HY031HLA051-03	16	WH	1N						220VACN	06A550CB10		TSB		15.3.2004
	NULL	06HY031HLA052-04	06A809-TB POWER-06	16	BK	1N						220 VAC	06A550CB10		TSB		15.3.2004
	NULL	06HY031HLA052-CHASSIS	06W1H	16	WH							FRM GND			TSB		15.3.2004
	NULL	06HY031HLA053-01	06HY031HLA052-01	16	WH	1N						220VACN	06A550CB10		TSB		15.3.2004
	NULL	06HY031HLA053-03	06HY031HLA052-03	16	WH	1N						220VACN	06A550CB10		TSB		15.3.2004
	NULL	06HY031HLA053-04	06A809-TB POWER-08	16	BK	1N						220 VAC	06A550CB10		TSB		15.3.2004
	NULL	06HY031HLA053-CHASSIS	06W1H	16	WH							FRM GND			TSB		15.3.2004
	NULL	06HY031HLA054-01	06HY031HLA053-01	16	WH	1N						220VACN	06A550CB10		TSB		15.3.2004
	NULL	06HY031HLA054-03	06HY031HLA053-03	16	WH	1N						220VACN	06A550CB10		TSB		15.3.2004
	NULL	06HY031HLA054-04	06A809-TB POWER-10	16	BK	1N						220 VAC	06A550CB10		TSB		15.3.2004
	NULL	06HY031HLA054-CHASSIS	06W1H	16	WH							FRM GND			TSB		15.3.2004
6	NULL	06A810-TB SIGNAL-02	06P02-01	22	WH		LO	0	038	00	06HY31PHLA001				TSB		15.3.2004
6	NULL	06A810-TB SIGNAL-04	06P02-02	22	WH		LO	0	038	01	06HY31PHLA002				TSB		15.3.2004
6	NULL	06A810-TB SIGNAL-06	06P02-03	22	WH		LO	0	038	02	06HY31PHLA003				TSB		15.3.2004
6	NULL	06A810-TB SIGNAL-08	06P02-04	22	WH		LO	0	038	03	06HY31PHLA004				TSB		15.3.2004
6	NULL	06A810-TB SIGNAL-10	06P02-05	22	WH		LO	0	038	04	06HY31PHLA005				TSB		15.3.2004
6	NULL	06A810-TB SIGNAL-12	06P02-06	22	WH		LO	0	038	05	06HY31PHLA006				TSB		15.3.2004
6	NULL	06A810-TB SIGNAL-14	06P02-07	22	WH		LO	0	038	06	06HY31PHLA007				TSB		15.3.2004
6	NULL	06A810-TB SIGNAL-16	06P02-08	22	WH		LO	0	038	07	06HY31PHLA008				TSB		15.3.2004
6	NULL	06A810-TB SIGNAL-18	06P02-09	22	WH		LO	0	038	08	06HY31PHLA009				TSB		15.3.2004
6	NULL	06A810-TB SIGNAL-20	06P02-10	22	WH		LO	0	038	09	06HY31PHLA010				TSB		15.3.2004
6	NULL	06A810-TB SIGNAL-22	06P02-11	22	WH		LO	0	038	10	06HY31PHLA011				TSB		15.3.2004
6	NULL	06A810-TB SIGNAL-24	06P02-12	22	WH		LO	0	038	11	06HY31PHLA012				TSB		15.3.2004
6	NULL	06A810-TB SIGNAL-26	06P02-14	22	WH		LO	0	038	12	06HY31PHLA013				TSB		15.3.2004
6	NULL	06A810-TB SIGNAL-28	06P02-14	22	WH		LO	0	038	13	06HY31PHLA014				TSB		15.3.2004
6	NULL	06A810-TB SIGNAL-30	06P02-15	22	WH		LO	0	038	14	06HY31PHLA015				TSB		15.3.2004
6	NULL	06A810-TB SIGNAL-32	06P02-16	22	WH		LO	0	038	15	06HY31PHLA016				TSB		15.3.2004
6	NULL	06A811-TB SIGNAL-02	06P03-01	22	WH		LO	0	039	00	06HY31PHLA017				TSB		15.3.2004
6	NULL	06A811-TB SIGNAL-04	06P03-02	22	WH		LO	0	039	01	06HY31PHLA018				TSB		15.3.2004
6	NULL	06A811-TB SIGNAL-06	06P03-03	22	WH		LO	0	039	02	06HY31PHLA019				TSB		15.3.2004
6	NULL	06A811-TB SIGNAL-08	06P03-04	22	WH		LO	0	039	03	06HY31PHLA020				TSB		15.3.2004
6	NULL	06A811-TB SIGNAL-10	06P03-05	22	WH		LO	0	039	04	06HY31PHLA021				TSB		15.3.2004
6	NULL	06A811-TB SIGNAL-12	06P03-06	22	WH		LO	0	039	05	06HY31PHLA022				TSB		15.3.2004
6	NULL	06A811-TB SIGNAL-14	06P03-07	22	WH		LO	0	039	06	06HY31PHLA023				TSB		15.3.2004
6	NULL	06A811-TB SIGNAL-16	06P03-08	22	WH		LO	0	039	07	06HY31PHLA024				TSB		15.3.2004
6	NULL	06A811-TB SIGNAL-18	06P03-09	22	WH		LO	0	039	08	06HY31PHLA025				TSB		15.3.2004
6	NULL	06A811-TB SIGNAL-20	06P03-10	22	WH		LO	0	039	09	06HY31PHLA026				TSB		15.3.2004
6	NULL	06A811-TB SIGNAL-22	06P03-11	22	WH		LO	0	039	10	06HY31PHLA027				TSB		15.3.2004
6	NULL	06A811-TB SIGNAL-24	06P03-12	22	WH		LO	0	039	11	06HY31PHLA028				TSB		15.3.2004
6	NULL	06A811-TB SIGNAL-26	06P03-13	22	WH		LO	0	039	12	06HY31PHLA029				TSB		15.3.2004
6	NULL	06A811-TB SIGNAL-28	06P03-14	22	WH		LO	0	039	13	06HY31PHLA030				TSB		15.3.2004
6	NULL	06A811-TB SIGNAL-30	06P03-15	22	WH		LO	0	039	14	06HY31PHLA031				TSB		15.3.2004

coord	coord_	From	To	WC	CC	NC	IO	SC	Word	bit	remarks	power	origin	daisy_	ped	rev_le	write_date
6	NULL	06A811-TB SIGNAL-32	06P03-16	22	WH		LO	0	039	15	06HY31PHLA032				TSB		15.3.2004
6	NULL	06A809-TB SIGNAL-04	06A530-A2P12-02	22	WH		LO	1	009	01	06HY31PHLA033				TSB		15.3.2004
6	NULL	06A809-TB SIGNAL-06	06A530-A2P12-03	22	WH		LO	1	009	02	06HY31PHLA034				TSB		15.3.2004
6	NULL	06A809-TB SIGNAL-08	06A530-A2P12-04	22	WH		LO	1	009	03	06HY31PHLA035				TSB		15.3.2004
6	NULL	06A809-TB SIGNAL-10	06A530-A2P12-05	22	WH		LO	1	009	04	06HY31PHLA036				TSB		15.3.2004
	NULL	06A802-TB SIGNAL-10	06A530-A2P05-05	22	WH		LO	1	002	04	06HY031HLA001				TSB		15.3.2004
	NULL	06A802-TB SIGNAL-12	06A530-A2P05-06	22	WH		LO	1	002	05	06HY031HLA002				TSB		15.3.2004
	NULL	06A802-TB SIGNAL-14	06A530-A2P05-07	22	WH		LO	1	002	06	06HY031HLA003				TSB		15.3.2004
	NULL	06A802-TB SIGNAL-16	06A530-A2P05-08	22	WH		LO	1	002	07	06HY031HLA004				TSB		15.3.2004
	NULL	06A802-TB SIGNAL-18	06A530-A2P05-09	22	WH		LO	1	002	08	06HY031HLA005				TSB		15.3.2004
	NULL	06A802-TB SIGNAL-20	06A530-A2P05-10	22	WH		LO	1	002	09	06HY031HLA006				TSB		15.3.2004
	NULL	06A802-TB SIGNAL-22	06A530-A2P05-11	22	WH		LO	1	002	10	06HY031HLA007				TSB		15.3.2004
	NULL	06A802-TB SIGNAL-24	06A530-A2P05-12	22	WH		LO	1	002	11	06HY031HLA008				TSB		15.3.2004
	NULL	06A802-TB SIGNAL-26	06A530-A2P05-13	22	WH		LO	1	002	12	06HY031HLA009				TSB		15.3.2004
	NULL	06A802-TB SIGNAL-28	06A530-A2P05-14	22	WH		LO	1	002	13	06HY031HLA010				TSB		15.3.2004
	NULL	06A802-TB SIGNAL-30	06A530-A2P05-15	22	WH		LO	1	002	14	06HY031HLA011				TSB		15.3.2004
	NULL	06A802-TB SIGNAL-32	06A530-A2P05-16	22	WH		LO	1	002	15	06HY031HLA012				TSB		15.3.2004
	NULL	06A803-TB SIGNAL-02	06A530-A2P06-01	22	WH		LO	1	003	00	06HY031HLA013				TSB		15.3.2004
	NULL	06A803-TB SIGNAL-04	06A530-A2P06-02	22	WH		LO	1	003	01	06HY031HLA014				TSB		15.3.2004
	NULL	06A803-TB SIGNAL-06	06A530-A2P06-03	22	WH		LO	1	003	02	06HY031HLA015				TSB		15.3.2004
	NULL	06A803-TB SIGNAL-08	06A530-A2P06-04	22	WH		LO	1	003	03	06HY031HLA016				TSB		15.3.2004
	NULL	06A803-TB SIGNAL-10	06A530-A2P06-05	22	WH		LO	1	003	04	06HY031HLA017				TSB		15.3.2004
	NULL	06A803-TB SIGNAL-12	06A530-A2P06-06	22	WH		LO	1	003	05	06HY031HLA018				TSB		15.3.2004
HY32																	
	NULL	06HY032HLA001-01	06A681-K02-05	16	WH	1N						220VACN	06A550CB03		TSB	D	15.3.2004
	NULL	06HY032HLA001-01	06HY032HLA002-01	16	WH	1N						220VACN	06A550CB03		TSB	D	15.3.2004
	NULL	06HY032HLA001-03	06A681-K01-05	16	WH	1N						220VACN	06A550CB03		TSB	D	15.3.2004
	NULL	06HY032HLA001-03	06HY032HLA002-03	16	WH	1N						220VACN	06A550CB03		TSB	D	15.3.2004
	NULL	06HY032HLA001-04	06A803-TB POWER-14	16	BK	1N						220 VAC	06A550CB03		TSB	D	15.3.2004
	NULL	06HY032HLA001-CHASSIS	06W1F	16	WH							FRM GND			TSB	D	15.3.2004
	NULL	06HY032HLA002-01	06HY032HLA003-01	16	WH	1N						220VACN	06A550CB03		TSB	D	15.3.2004
	NULL	06HY032HLA002-03	06HY032HLA003-03	16	WH	1N						220VACN	06A550CB03		TSB	D	15.3.2004
	NULL	06HY032HLA002-04	06A803-TB POWER-16	16	BK	1N						220 VAC	06A550CB03		TSB	D	15.3.2004
	NULL	06HY032HLA002-CHASSIS	06W1F	16	WH							FRM GND			TSB	D	15.3.2004
	NULL	06HY032HLA003-01	06HY032HLA004-01	16	WH	1N						220VACN	06A550CB03		TSB	D	15.3.2004
	NULL	06HY032HLA003-03	06HY032HLA004-03	16	WH	1N						220VACN	06A550CB03		TSB	D	15.3.2004
	NULL	06HY032HLA003-04	06A803-TB POWER-18	16	BK	1N						220 VAC	06A550CB03		TSB	D	15.3.2004
	NULL	06HY032HLA003-CHASSIS	06W1F	16	WH							FRM GND			TSB	D	15.3.2004
	NULL	06HY032HLA004-01	06HY032HLA005-01	16	WH	1N						220VACN	06A550CB03		TSB	D	15.3.2004
	NULL	06HY032HLA004-03	06HY032HLA005-03	16	WH	1N						220VACN	06A550CB03		TSB	D	15.3.2004
	NULL	06HY032HLA004-04	06A803-TB POWER-20	16	BK	1N						220 VAC	06A550CB03		TSB	D	15.3.2004
	NULL	06HY032HLA004-CHASSIS	06W1F	16	WH							FRM GND			TSB	D	15.3.2004
	NULL	06HY032HLA005-01	06HY032HLA010-01	16	WH	1N						220VACN	06A550CB03		TSB	D	15.3.2004
	NULL	06HY032HLA005-03	06HY032HLA010-03	16	WH	1N						220VACN	06A550CB03		TSB	D	15.3.2004
	NULL	06HY032HLA005-04	06A803-TB POWER-22	16	BK	1N						220 VAC	06A550CB03		TSB	D	15.3.2004
	NULL	06HY032HLA005-CHASSIS	06W1F	16	WH							FRM GND			TSB	D	15.3.2004
	NULL	06HY032HLA006-01	06HY032HLA007-01	16	WH	1N						220VACN	06A550CB03		TSB	D	15.3.2004
	NULL	06HY032HLA006-01	06HY032HLA011-01	16	WH	1N						220VACN	06A550CB03		TSB	D	15.3.2004
	NULL	06HY032HLA006-03	06HY032HLA007-03	16	WH	1N						220VACN	06A550CB03		TSB	D	15.3.2004
	NULL	06HY032HLA006-03	06HY032HLA011-03	16	WH	1N						220VACN	06A550CB03		TSB	D	15.3.2004
	NULL	06HY032HLA006-04	06A803-TB POWER-24	16	BK	1N						220 VAC	06A550CB03		TSB	D	15.3.2004
	NULL	06HY032HLA006-CHASSIS	06W1F	16	WH							FRM GND			TSB	D	15.3.2004
	NULL	06HY032HLA007-01	06HY032HLA008-01	16	WH	1N						220VACN	06A550CB03		TSB	D	15.3.2004
	NULL	06HY032HLA007-03	06HY032HLA008-03	16	WH	1N						220VACN	06A550CB03		TSB	D	15.3.2004

coord	coord_	From	To	WC	CC	NC	IO	SC	Word	bit	remarks	power	origin	daisy_	ped	rev_le	write_date
	NULL	06HY032HLA007-04	06A803-TB POWER-26	16	BK	1N						220 VAC	06A550CB03		TSB	D	15.3.2004
	NULL	06HY032HLA007-CHASSIS	06W1F	16	WH							FRM GND			TSB	D	15.3.2004
	NULL	06HY032HLA008-01	06HY032HLA009-01	16	WH	1N						220VACN	06A550CB03		TSB	D	15.3.2004
	NULL	06HY032HLA008-03	06HY032HLA009-03	16	WH	1N						220VACN	06A550CB03		TSB	D	15.3.2004
	NULL	06HY032HLA008-04	06A803-TB POWER-28	16	BK	1N						220 VAC	06A550CB03		TSB	D	15.3.2004
	NULL	06HY032HLA008-CHASSIS	06W1F	16	WH							FRM GND			TSB	D	15.3.2004
	NULL	06HY032HLA009-01	06HY032HLA010-01	16	WH	1N						220VACN	06A550CB03		TSB	D	15.3.2004
	NULL	06HY032HLA009-03	06HY032HLA010-03	16	WH	1N						220VACN	06A550CB03		TSB	D	15.3.2004
	NULL	06HY032HLA009-04	06A803-TB POWER-30	16	BK	1N						220 VAC	06A550CB03		TSB	D	15.3.2004
	NULL	06HY032HLA009-CHASSIS	06W1F	16	WH							FRM GND			TSB	D	15.3.2004
	NULL	06HY032HLA010-04	06A803-TB POWER-32	16	BK	1N						220 VAC	06A550CB03		TSB	D	15.3.2004
	NULL	06HY032HLA010-CHASSIS	06W1F	16	WH							FRM GND			TSB	D	15.3.2004
	NULL	06HY032HLA011-01	06HY032HLA012-01	16	WH	1N						220VACN	06A550CB03		TSB	D	15.3.2004
	NULL	06HY032HLA011-03	06HY032HLA012-03	16	WH	1N						220VACN	06A550CB03		TSB	D	15.3.2004
	NULL	06HY032HLA011-04	06A804-TB POWER-02	16	BK	1N						220 VAC	06A550CB03		TSB	D	15.3.2004
	NULL	06HY032HLA011-CHASSIS	06W1F	16	WH							FRM GND			TSB	D	15.3.2004
	NULL	06HY032HLA012-01	06HY032HLA013-01	16	WH	1N						220VACN	06A550CB03		TSB	D	15.3.2004
	NULL	06HY032HLA012-03	06HY032HLA013-03	16	WH	1N						220VACN	06A550CB03		TSB	D	15.3.2004
	NULL	06HY032HLA012-04	06A804-TB POWER-04	16	BK	1N						220 VAC	06A550CB03		TSB	D	15.3.2004
	NULL	06HY032HLA012-CHASSIS	06W1F	16	WH							FRM GND			TSB	D	15.3.2004
	NULL	06HY032HLA013-01	06HY032HLA014-01	16	WH	1N						220VACN	06A550CB03		TSB	D	15.3.2004
	NULL	06HY032HLA013-03	06HY032HLA014-03	16	WH	1N						220VACN	06A550CB03		TSB	D	15.3.2004
	NULL	06HY032HLA013-04	06A804-TB POWER-06	16	BK	1N						220 VAC	06A550CB03		TSB	D	15.3.2004
	NULL	06HY032HLA013-CHASSIS	06W1F	16	WH							FRM GND			TSB	D	15.3.2004
	NULL	06HY032HLA014-01	06HY032HLA015-01	16	WH	1N						220VACN	06A550CB03		TSB	D	15.3.2004
	NULL	06HY032HLA014-03	06HY032HLA015-03	16	WH	1N						220VACN	06A550CB03		TSB	D	15.3.2004
	NULL	06HY032HLA014-04	06A804-TB POWER-08	16	BK	1N						220 VAC	06A550CB03		TSB	D	15.3.2004
	NULL	06HY032HLA014-CHASSIS	06W1F	16	WH							FRM GND			TSB	D	15.3.2004
	NULL	06HY032HLA015-01	06HY032HLA020-01	16	WH	1N						220VACN	06A550CB03		TSB	D	15.3.2004
	NULL	06HY032HLA015-03	06HY032HLA020-03	16	WH	1N						220VACN	06A550CB03		TSB	D	15.3.2004
	NULL	06HY032HLA015-04	06A804-TB POWER-10	16	BK	1N						220 VAC	06A550CB03		TSB	D	15.3.2004
	NULL	06HY032HLA015-CHASSIS	06W1F	16	WH							FRM GND			TSB	D	15.3.2004
	NULL	06HY032HLA016-01	06HY032HLA017-01	16	WH	1N						220VACN	06A550CB03		TSB	D	15.3.2004
	NULL	06HY032HLA016-01	06HY032HLA021-01	16	WH	1N						220VACN	06A550CB03		TSB	D	15.3.2004
	NULL	06HY032HLA016-03	06HY032HLA017-03	16	WH	1N						220VACN	06A550CB03		TSB	D	15.3.2004
	NULL	06HY032HLA016-03	06HY032HLA021-03	16	WH	1N						220VACN	06A550CB03		TSB	D	15.3.2004
	NULL	06HY032HLA016-04	06A804-TB POWER-12	16	BK	1N						220 VAC	06A550CB03		TSB	D	15.3.2004
	NULL	06HY032HLA016-CHASSIS	06W1F	16	WH							FRM GND			TSB	D	15.3.2004
	NULL	06HY032HLA017-01	06HY032HLA018-01	16	WH	1N						220VACN	06A550CB03		TSB	D	15.3.2004
	NULL	06HY032HLA017-03	06HY032HLA018-03	16	WH	1N						220VACN	06A550CB03		TSB	D	15.3.2004
	NULL	06HY032HLA017-04	06A804-TB POWER-14	16	BK	1N						220 VAC	06A550CB03		TSB	D	15.3.2004
	NULL	06HY032HLA017-CHASSIS	06W1F	16	WH							FRM GND			TSB	D	15.3.2004
	NULL	06HY032HLA018-01	06HY032HLA019-01	16	WH	1N						220VACN	06A550CB03		TSB	D	15.3.2004
	NULL	06HY032HLA018-03	06HY032HLA019-03	16	WH	1N						220VACN	06A550CB03		TSB	D	15.3.2004
	NULL	06HY032HLA018-04	06A804-TB POWER-16	16	BK	1N						220 VAC	06A550CB03		TSB	D	15.3.2004
	NULL	06HY032HLA018-CHASSIS	06W1F	16	WH							FRM GND			TSB	D	15.3.2004
	NULL	06HY032HLA019-01	06HY032HLA020-01	16	WH	1N						220VACN	06A550CB03		TSB	D	15.3.2004
	NULL	06HY032HLA019-03	06HY032HLA020-03	16	WH	1N						220VACN	06A550CB03		TSB	D	15.3.2004
	NULL	06HY032HLA019-04	06A804-TB POWER-18	16	BK	1N						220 VAC	06A550CB03		TSB	D	15.3.2004
	NULL	06HY032HLA019-CHASSIS	06W1G	16	WH							FRM GND			TSB	D	15.3.2004
	NULL	06HY032HLA020-04	06A804-TB POWER-20	16	BK	1N						220 VAC	06A550CB03		TSB	D	15.3.2004
	NULL	06HY032HLA020-CHASSIS	06W1G	16	WH							FRM GND			TSB	D	15.3.2004
	NULL	06HY032HLA021-01	06HY032HLA022-01	16	WH	1N						220VACN	06A550CB03		TSB	D	15.3.2004
	NULL	06HY032HLA021-03	06HY032HLA022-03	16	WH	1N						220VACN	06A550CB03		TSB	D	15.3.2004

coord	coord_	From	To	WC	CC	NC	IO	SC	Word	bit	remarks	power	origin	daisy_	ped	rev_le	write_date
	NULL	06HY032HLA021-04	06A804-TB POWER-22	16	BK	1N						220 VAC	06A550CB03		TSB	D	15.3.2004
	NULL	06HY032HLA021-CHASSIS	06W1G	16	WH							FRM GND			TSB	D	15.3.2004
	NULL	06HY032HLA022-01	06HY032HLA023-01	16	WH	1N						220VACN	06A550CB03		TSB	D	15.3.2004
	NULL	06HY032HLA022-03	06HY032HLA023-03	16	WH	1N						220VACN	06A550CB03		TSB	D	15.3.2004
	NULL	06HY032HLA022-04	06A804-TB POWER-24	16	BK	1N						220 VAC	06A550CB03		TSB	D	15.3.2004
	NULL	06HY032HLA022-CHASSIS	06W1G	16	WH							FRM GND			TSB	D	15.3.2004
	NULL	06HY032HLA023-01	06HY032HLA024-01	16	WH	1N						220VACN	06A550CB03		TSB	D	15.3.2004
	NULL	06HY032HLA023-03	06HY032HLA024-03	16	WH	1N						220VACN	06A550CB03		TSB	D	15.3.2004
	NULL	06HY032HLA023-04	06A804-TB POWER-26	16	BK	1N						220 VAC	06A550CB03		TSB	D	15.3.2004
	NULL	06HY032HLA023-CHASSIS	06W1G	16	WH							FRM GND			TSB	D	15.3.2004
	NULL	06HY032HLA024-01	06HY032HLA025-01	16	WH	1N						220VACN	06A550CB03		TSB	D	15.3.2004
	NULL	06HY032HLA024-03	06HY032HLA025-03	16	WH	1N						220VACN	06A550CB03		TSB	D	15.3.2004
	NULL	06HY032HLA024-04	06A804-TB POWER-28	16	BK	1N						220 VAC	06A550CB03		TSB	D	15.3.2004
	NULL	06HY032HLA024-CHASSIS	06W1G	16	WH							FRM GND			TSB	D	15.3.2004
	NULL	06HY032HLA025-01	06HY032HLA026-01	16	WH	1N						220VACN	06A550CB03		TSB	D	15.3.2004
	NULL	06HY032HLA025-03	06HY032HLA026-03	16	WH	1N						220VACN	06A550CB03		TSB	D	15.3.2004
	NULL	06HY032HLA025-04	06A804-TB POWER-30	16	BK	1N						220 VAC	06A550CB03		TSB	D	15.3.2004
	NULL	06HY032HLA025-CHASSIS	06W1G	16	WH							FRM GND			TSB	D	15.3.2004
	NULL	06HY032HLA026-04	06A804-TB POWER-32	16	BK	1N						220 VAC	06A550CB03		TSB	D	15.3.2004
	NULL	06HY032HLA026-CHASSIS	06W1G	16	WH							FRM GND			TSB	D	15.3.2004
	NULL	06HY032HLA027-01	06HY032HLA028-01	16	WH	1N						220VACN	06A550CB04		TSB	D	15.3.2004
	NULL	06HY032HLA027-03	06HY032HLA028-03	16	WH	1N						220VACN	06A550CB04		TSB	D	15.3.2004
	NULL	06HY032HLA027-04	06A805-TB POWER-02	16	BK	1N						220 VAC	06A550CB04		TSB	D	15.3.2004
	NULL	06HY032HLA027-CHASSIS	06W1G	16	WH							FRM GND			TSB	D	15.3.2004
	NULL	06HY032HLA028-01	06HY032HLA029-01	16	WH	1N						220VACN	06A550CB04		TSB	D	15.3.2004
	NULL	06HY032HLA028-03	06HY032HLA029-03	16	WH	1N						220VACN	06A550CB04		TSB	D	15.3.2004
	NULL	06HY032HLA028-04	06A805-TB POWER-04	16	BK	1N						220 VAC	06A550CB04		TSB	D	15.3.2004
	NULL	06HY032HLA028-CHASSIS	06W1G	16	WH							FRM GND			TSB	D	15.3.2004
	NULL	06HY032HLA029-01	06HY032HLA030-01	16	WH	1N						220VACN	06A550CB04		TSB	D	15.3.2004
	NULL	06HY032HLA029-03	06HY032HLA030-03	16	WH	1N						220VACN	06A550CB04		TSB	D	15.3.2004
	NULL	06HY032HLA029-04	06A805-TB POWER-06	16	BK	1N						220 VAC	06A550CB04		TSB	D	15.3.2004
	NULL	06HY032HLA029-CHASSIS	06W1G	16	WH							FRM GND			TSB	D	15.3.2004
	NULL	06HY032HLA030-01	06HY032HLA031-01	16	WH	1N						220VACN	06A550CB04		TSB	D	15.3.2004
	NULL	06HY032HLA030-03	06HY032HLA031-03	16	WH	1N						220VACN	06A550CB04		TSB	D	15.3.2004
	NULL	06HY032HLA030-04	06A805-TB POWER-08	16	BK	1N						220 VAC	06A550CB04		TSB	D	15.3.2004
	NULL	06HY032HLA030-CHASSIS	06W1G	16	WH							FRM GND			TSB	D	15.3.2004
	NULL	06HY032HLA031-01	06HY032HLA032-01	16	WH	1N						220VACN	06A550CB04		TSB	D	15.3.2004
	NULL	06HY032HLA031-03	06HY032HLA032-03	16	WH	1N						220VACN	06A550CB04		TSB	D	15.3.2004
	NULL	06HY032HLA031-04	06A805-TB POWER-10	16	BK	1N						220 VAC	06A550CB04		TSB	D	15.3.2004
	NULL	06HY032HLA031-CHASSIS	06W1G	16	WH							FRM GND			TSB	D	15.3.2004
	NULL	06HY032HLA032-01	06HY032HLA033-01	16	WH	1N						220VACN	06A550CB04		TSB	D	15.3.2004
	NULL	06HY032HLA032-03	06HY032HLA033-03	16	WH	1N						220VACN	06A550CB04		TSB	D	15.3.2004
	NULL	06HY032HLA032-04	06A805-TB POWER-12	16	BK	1N						220 VAC	06A550CB04		TSB	D	15.3.2004
	NULL	06HY032HLA032-CHASSIS	06W1G	16	WH							FRM GND			TSB	D	15.3.2004
	NULL	06HY032HLA033-01	06HY032HLA034-01	16	WH	1N						220VACN	06A550CB04		TSB	D	15.3.2004
	NULL	06HY032HLA033-03	06HY032HLA034-03	16	WH	1N						220VACN	06A550CB04		TSB	D	15.3.2004
	NULL	06HY032HLA033-04	06A805-TB POWER-14	16	BK	1N						220 VAC	06A550CB04		TSB	D	15.3.2004
	NULL	06HY032HLA033-CHASSIS	06W1G	16	WH							FRM GND			TSB	D	15.3.2004
	NULL	06HY032HLA034-01	06HY032HLA035-01	16	WH	1N						220VACN	06A550CB04		TSB	D	15.3.2004
	NULL	06HY032HLA034-03	06HY032HLA035-03	16	WH	1N						220VACN	06A550CB04		TSB	D	15.3.2004
	NULL	06HY032HLA034-04	06A805-TB POWER-16	16	BK	1N						220 VAC	06A550CB04		TSB	D	15.3.2004
	NULL	06HY032HLA034-CHASSIS	06W1G	16	WH							FRM GND			TSB	D	15.3.2004
	NULL	06HY032HLA035-01	06HY032HLA040-01	16	WH	1N						220VACN	06A550CB04		TSB	D	15.3.2004
	NULL	06HY032HLA035-03	06HY032HLA036-03	16	WH	1N						220VACN	06A550CB04		TSB	D	15.3.2004

coord	coord_	From	To	WC	CC	NC	IO	SC	Word	bit	remarks	power	origin	daisy_	ped	rev_le	write_date
	NULL	06HY032HLA035-04	06A805-TB POWER-18	16	BK	1N						220 VAC	06A550CB04		TSB	D	15.3.2004
	NULL	06HY032HLA035-CHASSIS	06W1G	16	WH							FRM GND			TSB	D	15.3.2004
	NULL	06HY032HLA036-01	06HY032HLA037-01	16	WH	1N						220VACN	06A550CB04		TSB	D	15.3.2004
	NULL	06HY032HLA036-01	06HY032HLA041-01	16	WH	1N						220VACN	06A550CB04		TSB	D	15.3.2004
	NULL	06HY032HLA036-03	06HY032HLA037-03	16	WH	1N						220VACN	06A550CB04		TSB	D	15.3.2004
	NULL	06HY032HLA036-04	06A805-TB POWER-20	16	BK	1N						220 VAC	06A550CB04		TSB	D	15.3.2004
	NULL	06HY032HLA036-CHASSIS	06W1G	16	WH							FRM GND			TSB	D	15.3.2004
	NULL	06HY032HLA037-01	06HY032HLA038-01	16	WH	1N						220VACN	06A550CB04		TSB	D	15.3.2004
	NULL	06HY032HLA037-03	06HY032HLA038-03	16	WH	1N						220VACN	06A550CB04		TSB	D	15.3.2004
	NULL	06HY032HLA037-04	06A805-TB POWER-22	16	BK	1N						220 VAC	06A550CB04		TSB	D	15.3.2004
	NULL	06HY032HLA037-CHASSIS	06W1H	16	WH							FRM GND			TSB	D	15.3.2004
	NULL	06HY032HLA038-01	06HY032HLA039-01	16	WH	1N						220VACN	06A550CB04		TSB	D	15.3.2004
	NULL	06HY032HLA038-03	06HY032HLA039-03	16	WH	1N						220VACN	06A550CB04		TSB	D	15.3.2004
	NULL	06HY032HLA038-04	06A805-TB POWER-24	16	BK	1N						220 VAC	06A550CB04		TSB	D	15.3.2004
	NULL	06HY032HLA038-CHASSIS	06W1H	16	WH							FRM GND			TSB	D	15.3.2004
	NULL	06HY032HLA039-01	06HY032HLA040-01	16	WH	1N						220VACN	06A550CB04		TSB	D	15.3.2004
	NULL	06HY032HLA039-03	06HY032HLA040-03	16	WH	1N						220VACN	06A550CB04		TSB	D	15.3.2004
	NULL	06HY032HLA039-04	06A805-TB POWER-26	16	BK	1N						220 VAC	06A550CB04		TSB	D	15.3.2004
	NULL	06HY032HLA039-CHASSIS	06W1H	16	WH							FRM GND			TSB	D	15.3.2004
	NULL	06HY032HLA040-03	06HY032HLA041-03	16	WH	1N						220VACN	06A550CB04		TSB	D	15.3.2004
	NULL	06HY032HLA040-04	06A805-TB POWER-28	16	BK	1N						220 VAC	06A550CB04		TSB	D	15.3.2004
	NULL	06HY032HLA040-CHASSIS	06W1H	16	WH							FRM GND			TSB	D	15.3.2004
	NULL	06HY032HLA041-01	06HY032HLA042-01	16	WH	1N						220VACN	06A550CB04		TSB	D	15.3.2004
	NULL	06HY032HLA041-03	06HY032HLA042-03	16	WH	1N						220VACN	06A550CB04		TSB	D	15.3.2004
	NULL	06HY032HLA041-04	06A805-TB POWER-30	16	BK	1N						220 VAC	06A550CB04		TSB	D	15.3.2004
	NULL	06HY032HLA041-CHASSIS	06W1H	16	WH							FRM GND			TSB	D	15.3.2004
	NULL	06HY032HLA042-01	06HY032HLA043-01	16	WH	1N						220VACN	06A550CB04		TSB	D	15.3.2004
	NULL	06HY032HLA042-03	06HY032HLA043-03	16	WH	1N						220VACN	06A550CB04		TSB	D	15.3.2004
	NULL	06HY032HLA042-04	06A805-TB POWER-32	16	BK	1N						220 VAC	06A550CB04		TSB	D	15.3.2004
	NULL	06HY032HLA042-CHASSIS	06W1H	16	WH							FRM GND			TSB	D	15.3.2004
	NULL	06HY032HLA043-01	06HY032HLA044-01	16	WH	1N						220VACN	06A550CB04		TSB	D	15.3.2004
	NULL	06HY032HLA043-03	06HY032HLA044-03	16	WH	1N						220VACN	06A550CB04		TSB	D	15.3.2004
	NULL	06HY032HLA043-04	06A806-TB POWER-02	16	BK	1N						220 VAC	06A550CB04		TSB	D	15.3.2004
	NULL	06HY032HLA043-CHASSIS	06W1H	16	WH							FRM GND			TSB	D	15.3.2004
	NULL	06HY032HLA044-01	06HY032HLA045-01	16	WH	1N						220VACN	06A550CB04		TSB	D	15.3.2004
	NULL	06HY032HLA044-03	06HY032HLA045-03	16	WH	1N						220VACN	06A550CB04		TSB	D	15.3.2004
	NULL	06HY032HLA044-04	06A806-TB POWER-04	16	BK	1N						220 VAC	06A550CB04		TSB	D	15.3.2004
	NULL	06HY032HLA044-CHASSIS	06W1H	16	WH							FRM GND			TSB	D	15.3.2004
	NULL	06HY032HLA045-01	06HY032HLA050-01	16	WH	1N						220VACN	06A550CB04		TSB	D	15.3.2004
	NULL	06HY032HLA045-03	06HY032HLA046-03	16	WH	1N						220VACN	06A550CB04		TSB	D	15.3.2004
	NULL	06HY032HLA045-04	06A806-TB POWER-06	16	BK	1N						220 VAC	06A550CB04		TSB	D	15.3.2004
	NULL	06HY032HLA045-CHASSIS	06W1H	16	WH							FRM GND			TSB	D	15.3.2004
	NULL	06HY032HLA046-01	06HY032HLA047-01	16	WH	1N						220VACN	06A550CB04		TSB	D	15.3.2004
	NULL	06HY032HLA046-03	06HY032HLA047-03	16	WH	1N						220VACN	06A550CB04		TSB	D	15.3.2004
	NULL	06HY032HLA046-04	06A806-TB POWER-08	16	BK	1N						220 VAC	06A550CB04		TSB	D	15.3.2004
	NULL	06HY032HLA046-CHASSIS	06W1H	16	WH							FRM GND			TSB	D	15.3.2004
	NULL	06HY032HLA047-01	06HY032HLA048-01	16	WH	1N						220VACN	06A550CB04		TSB	D	15.3.2004
	NULL	06HY032HLA047-03	06HY032HLA048-03	16	WH	1N						220VACN	06A550CB04		TSB	D	15.3.2004
	NULL	06HY032HLA047-04	06A806-TB POWER-10	16	BK	1N						220 VAC	06A550CB04		TSB	D	15.3.2004
	NULL	06HY032HLA047-CHASSIS	06W1H	16	WH							FRM GND			TSB	D	15.3.2004
	NULL	06HY032HLA048-01	06HY032HLA049-01	16	WH	1N						220VACN	06A550CB04		TSB	D	15.3.2004
	NULL	06HY032HLA048-03	06HY032HLA049-03	16	WH	1N						220VACN	06A550CB04		TSB	D	15.3.2004
	NULL	06HY032HLA048-04	06A806-TB POWER-12	16	BK	1N						220 VAC	06A550CB04		TSB	D	15.3.2004
	NULL	06HY032HLA048-CHASSIS	06W1H	16	WH							FRM GND			TSB	D	15.3.2004

coord	coord_	From	To	WC	CC	NC	IO	SC	Word	bit	remarks	power	origin	daisy_	ped	rev_le	write_date
	NULL	06HY032HLA049-01	06HY032HLA050-01	16	WH	1N						220VACN	06A550CB04		TSB	D	15.3.2004
	NULL	06HY032HLA049-03	06HY032HLA050-03	16	WH	1N						220VACN	06A550CB04		TSB	D	15.3.2004
	NULL	06HY032HLA049-04	06A806-TB POWER-14	16	BK	1N						220 VAC	06A550CB04		TSB	D	15.3.2004
	NULL	06HY032HLA049-CHASSIS	06W1H	16	WH							FRM GND			TSB	D	15.3.2004
	NULL	06HY032HLA050-04	06A806-TB POWER-16	16	BK	1N						220 VAC	06A550CB04		TSB	D	15.3.2004
	NULL	06HY032HLA050-CHASSIS	06W1H	16	WH							FRM GND			TSB	D	15.3.2004
	NULL	06A803-TB SIGNAL-14	06A530-A2P06-07	22	WH		LO	1	003	06	06HY032HLA001				TSB		15.3.2004
	NULL	06A803-TB SIGNAL-16	06A530-A2P06-08	22	WH		LO	1	003	07	06HY032HLA002				TSB		15.3.2004
	NULL	06A803-TB SIGNAL-18	06A530-A2P06-09	22	WH		LO	1	003	08	06HY032HLA003				TSB		15.3.2004
	NULL	06A803-TB SIGNAL-20	06A530-A2P06-10	22	WH		LO	1	003	09	06HY032HLA004				TSB		15.3.2004
	NULL	06A803-TB SIGNAL-22	06A530-A2P06-11	22	WH		LO	1	003	10	06HY032HLA005				TSB		15.3.2004
	NULL	06A803-TB SIGNAL-24	06A530-A2P06-12	22	WH		LO	1	003	11	06HY032HLA006				TSB		15.3.2004
	NULL	06A803-TB SIGNAL-26	06A530-A2P06-13	22	WH		LO	1	003	12	06HY032HLA007				TSB		15.3.2004
	NULL	06A803-TB SIGNAL-28	06A530-A2P06-14	22	WH		LO	1	003	13	06HY032HLA008				TSB		15.3.2004
	NULL	06A803-TB SIGNAL-30	06A530-A2P06-15	22	WH		LO	1	003	14	06HY032HLA009				TSB		15.3.2004
	NULL	06A803-TB SIGNAL-32	06A530-A2P06-16	22	WH		LO	1	003	15	06HY032HLA010				TSB		15.3.2004
	NULL	06A804-TB SIGNAL-02	06A530-A2P07-01	22	WH		LO	1	004	00	06HY032HLA011				TSB		15.3.2004
	NULL	06A804-TB SIGNAL-04	06A530-A2P07-02	22	WH		LO	1	004	01	06HY032HLA012				TSB		15.3.2004
	NULL	06A804-TB SIGNAL-06	06A530-A2P07-03	22	WH		LO	1	004	02	06HY032HLA013				TSB		15.3.2004
	NULL	06A804-TB SIGNAL-08	06A530-A2P07-04	22	WH		LO	1	004	03	06HY032HLA014				TSB		15.3.2004
	NULL	06A804-TB SIGNAL-10	06A530-A2P07-05	22	WH		LO	1	004	04	06HY032HLA015				TSB		15.3.2004
	NULL	06A804-TB SIGNAL-12	06A530-A2P07-06	22	WH		LO	1	004	05	06HY032HLA016				TSB		15.3.2004
	NULL	06A804-TB SIGNAL-14	06A530-A2P07-07	22	WH		LO	1	004	06	06HY032HLA017				TSB		15.3.2004
	NULL	06A804-TB SIGNAL-16	06A530-A2P07-08	22	WH		LO	1	004	07	06HY032HLA018				TSB		15.3.2004
	NULL	06A804-TB SIGNAL-18	06A530-A2P07-09	22	WH		LO	1	004	08	06HY032HLA019				TSB		15.3.2004
	NULL	06A804-TB SIGNAL-20	06A530-A2P07-10	22	WH		LO	1	004	09	06HY032HLA020				TSB		15.3.2004
	NULL	06A804-TB SIGNAL-22	06A530-A2P07-11	22	WH		LO	1	004	10	06HY032HLA021				TSB		15.3.2004
	NULL	06A804-TB SIGNAL-24	06A530-A2P07-12	22	WH		LO	1	004	11	06HY032HLA022				TSB		15.3.2004
	NULL	06A804-TB SIGNAL-26	06A530-A2P07-13	22	WH		LO	1	004	12	06HY032HLA023				TSB		15.3.2004
	NULL	06A804-TB SIGNAL-28	06A530-A2P07-14	22	WH		LO	1	004	13	06HY032HLA024				TSB		15.3.2004
	NULL	06A804-TB SIGNAL-30	06A530-A2P07-15	22	WH		LO	1	004	14	06HY032HLA025				TSB		15.3.2004
	NULL	06A804-TB SIGNAL-32	06A530-A2P07-16	22	WH		LO	1	004	15	06HY032HLA026				TSB		15.3.2004
	NULL	06A805-TB SIGNAL-02	06A530-A2P08-01	22	WH		LO	1	005	00	06HY032HLA027				TSB		15.3.2004
	NULL	06A805-TB SIGNAL-04	06A530-A2P08-02	22	WH		LO	1	005	01	06HY032HLA028				TSB		15.3.2004
	NULL	06A805-TB SIGNAL-06	06A530-A2P08-03	22	WH		LO	1	005	02	06HY032HLA029				TSB		15.3.2004
	NULL	06A805-TB SIGNAL-08	06A530-A2P08-04	22	WH		LO	1	005	03	06HY032HLA030				TSB		15.3.2004
	NULL	06A805-TB SIGNAL-10	06A530-A2P08-05	22	WH		LO	1	005	04	06HY032HLA031				TSB		15.3.2004
	NULL	06A805-TB SIGNAL-12	06A530-A2P08-06	22	WH		LO	1	005	05	06HY032HLA032				TSB		15.3.2004
	NULL	06A805-TB SIGNAL-14	06A530-A2P08-07	22	WH		LO	1	005	06	06HY032HLA033				TSB		15.3.2004
	NULL	06A805-TB SIGNAL-16	06A530-A2P08-08	22	WH		LO	1	005	07	06HY032HLA034				TSB		15.3.2004
	NULL	06A805-TB SIGNAL-18	06A530-A2P08-09	22	WH		LO	1	005	08	06HY032HLA035				TSB		15.3.2004
	NULL	06A805-TB SIGNAL-20	06A530-A2P08-10	22	WH		LO	1	005	09	06HY032HLA036				TSB		15.3.2004
	NULL	06A805-TB SIGNAL-22	06A530-A2P08-11	22	WH		LO	1	005	10	06HY032HLA037				TSB		15.3.2004
	NULL	06A805-TB SIGNAL-24	06A530-A2P08-12	22	WH		LO	1	005	11	06HY032HLA038				TSB		15.3.2004
	NULL	06A805-TB SIGNAL-26	06A530-A2P08-13	22	WH		LO	1	005	12	06HY032HLA039				TSB		15.3.2004
	NULL	06A805-TB SIGNAL-28	06A530-A2P08-14	22	WH		LO	1	005	13	06HY032HLA040				TSB		15.3.2004
	NULL	06A805-TB SIGNAL-30	06A530-A2P08-15	22	WH		LO	1	005	14	06HY032HLA041				TSB		15.3.2004
	NULL	06A805-TB SIGNAL-32	06A530-A2P08-16	22	WH		LO	1	005	15	06HY032HLA042				TSB		15.3.2004
	NULL	06A806-TB SIGNAL-02	06A530-A2P09-01	22	WH		LO	1	006	00	06HY032HLA043				TSB		15.3.2004
	NULL	06A806-TB SIGNAL-04	06A530-A2P09-02	22	WH		LO	1	006	01	06HY032HLA044				TSB		15.3.2004
	NULL	06A806-TB SIGNAL-06	06A530-A2P09-03	22	WH		LO	1	006	02	06HY032HLA045				TSB		15.3.2004
	NULL	06A806-TB SIGNAL-08	06A530-A2P09-04	22	WH		LO	1	006	03	06HY032HLA046				TSB		15.3.2004
	NULL	06A806-TB SIGNAL-10	06A530-A2P09-05	22	WH		LO	1	006	04	06HY032HLA047				TSB		15.3.2004
	NULL	06A806-TB SIGNAL-12	06A530-A2P09-06	22	WH		LO	1	006	05	06HY032HLA048				TSB		15.3.2004

coord	coord_	From	To	WC	CC	NC	IO	SC	Word	bit	remarks	power	origin	daisy_	ped	rev_le	write_date
	NULL	06A806-TB SIGNAL-14	06A530-A2P09-07	22	WH		LO 1		006	06	06HY032HLA049				TSB		15.3.2004
	NULL	06A806-TB SIGNAL-16	06A530-A2P09-08	22	WH		LO 1		006	07	06HY032HLA050				TSB		15.3.2004
HY33																	
	NULL	06HY033HLA001-01	06A681-K03-05	16	WH	1N						220VACN	06A550CB04		TSB	D	15.3.2004
	NULL	06HY033HLA001-01	06HY033HLA002-01	16	WH	1N						220VACN	06A550CB04		TSB	D	15.3.2004
	NULL	06HY033HLA001-03	06A680-K10-NC	16	WH	1N						220VACN	06A550CB04		TSB	D	15.3.2004
	NULL	06HY033HLA001-03	06HY033HLA002-03	16	WH	1N						220VACN	06A550CB04		TSB	D	15.3.2004
	NULL	06HY033HLA001-04	06A806-TB POWER-18	16	BK	1N						220 VAC	06A550CB04		TSB	D	15.3.2004
	NULL	06HY033HLA001-CHASSIS	06W1H	16	WH							FRM GND			TSB	D	15.3.2004
	NULL	06HY033HLA002-01	06HY033HLA003-01	16	WH	1N						220VACN	06A550CB04		TSB	D	15.3.2004
	NULL	06HY033HLA002-03	06HY033HLA003-03	16	WH	1N						220VACN	06A550CB04		TSB	D	15.3.2004
	NULL	06HY033HLA002-04	06A806-TB POWER-20	16	BK	1N						220 VAC	06A550CB04		TSB	D	15.3.2004
	NULL	06HY033HLA002-CHASSIS	06W1H	16	WH							FRM GND			TSB	D	15.3.2004
	NULL	06HY033HLA003-01	06HY033HLA004-01	16	WH	1N						220VACN	06A550CB04		TSB	D	15.3.2004
	NULL	06HY033HLA003-03	06HY033HLA004-03	16	WH	1N						220VACN	06A550CB04		TSB	D	15.3.2004
	NULL	06HY033HLA003-04	06A806-TB POWER-22	16	BK	1N						220 VAC	06A550CB04		TSB	D	15.3.2004
	NULL	06HY033HLA003-CHASSIS	06W1H	16	WH							FRM GND			TSB	D	15.3.2004
	NULL	06HY033HLA004-01	06HY033HLA005-01	16	WH	1N						220VACN	06A550CB04		TSB	D	15.3.2004
	NULL	06HY033HLA004-03	06HY033HLA005-03	16	WH	1N						220VACN	06A550CB04		TSB	D	15.3.2004
	NULL	06HY033HLA004-04	06A806-TB POWER-24	16	BK	1N						220 VAC	06A550CB04		TSB	D	15.3.2004
	NULL	06HY033HLA004-CHASSIS	06W1H	16	WH							FRM GND			TSB	D	15.3.2004
	NULL	06HY033HLA005-01	06HY033HLA006-01	16	WH	1N						220VACN	06A550CB04		TSB	D	15.3.2004
	NULL	06HY033HLA005-03	06HY033HLA006-03	16	WH	1N						220VACN	06A550CB04		TSB	D	15.3.2004
	NULL	06HY033HLA005-04	06A806-TB POWER-26	16	BK	1N						220 VAC	06A550CB04		TSB	D	15.3.2004
	NULL	06HY033HLA005-CHASSIS	06W1D	16	WH							FRM GND			TSB	D	15.3.2004
	NULL	06HY033HLA006-01	06HY033HLA007-01	16	WH	1N						220VACN	06A550CB04		TSB	D	15.3.2004
	NULL	06HY033HLA006-03	06HY033HLA007-03	16	WH	1N						220VACN	06A550CB04		TSB	D	15.3.2004
	NULL	06HY033HLA006-04	06A806-TB POWER-28	16	BK	1N						220 VAC	06A550CB04		TSB	D	15.3.2004
	NULL	06HY033HLA006-CHASSIS	06W1D	16	WH							FRM GND			TSB	D	15.3.2004
	NULL	06HY033HLA007-01	06HY033HLA008-01	16	WH	1N						220VACN	06A550CB04		TSB	D	15.3.2004
	NULL	06HY033HLA007-03	06HY033HLA008-03	16	WH	1N						220VACN	06A550CB04		TSB	D	15.3.2004
	NULL	06HY033HLA007-04	06A806-TB POWER-30	16	BK	1N						220 VAC	06A550CB04		TSB	D	15.3.2004
	NULL	06HY033HLA007-CHASSIS	06W1D	16	WH							FRM GND			TSB	D	15.3.2004
	NULL	06HY033HLA008-01	06HY033HLA009-01	16	WH	1N						220VACN	06A550CB04		TSB	D	15.3.2004
	NULL	06HY033HLA008-03	06HY033HLA009-03	16	WH	1N						220VACN	06A550CB04		TSB	D	15.3.2004
	NULL	06HY033HLA008-04	06A806-TB POWER-32	16	BK	1N						220 VAC	06A550CB04		TSB	D	15.3.2004
	NULL	06HY033HLA008-CHASSIS	06W1D	16	WH							FRM GND			TSB	D	15.3.2004
	NULL	06HY033HLA009-01	06HY033HLA010-01	16	WH	1N						220VACN	06A550CB04		TSB	D	15.3.2004
	NULL	06HY033HLA009-03	06HY033HLA010-03	16	WH	1N						220VACN	06A550CB04		TSB	D	15.3.2004
	NULL	06HY033HLA009-04	06A807-TB POWER-02	16	BK	1N						220 VAC	06A550CB04		TSB	D	15.3.2004
	NULL	06HY033HLA009-CHASSIS	06W1D	16	WH							FRM GND			TSB	D	15.3.2004
	NULL	06HY033HLA010-01	06HY033HLA011-01	16	WH	1N						220VACN	06A550CB04		TSB	D	15.3.2004
	NULL	06HY033HLA010-03	06HY033HLA011-03	16	WH	1N						220VACN	06A550CB04		TSB	D	15.3.2004
	NULL	06HY033HLA010-04	06A807-TB POWER-04	16	BK	1N						220 VAC	06A550CB04		TSB	D	15.3.2004
	NULL	06HY033HLA010-CHASSIS	06W1D	16	WH							FRM GND			TSB	D	15.3.2004
	NULL	06HY033HLA011-01	06HY033HLA012-01	16	WH	1N						220VACN	06A550CB04		TSB	D	15.3.2004
	NULL	06HY033HLA011-03	06HY033HLA012-03	16	WH	1N						220VACN	06A550CB04		TSB	D	15.3.2004
	NULL	06HY033HLA011-04	06A807-TB POWER-06	16	BK	1N						220 VAC	06A550CB04		TSB	D	15.3.2004
	NULL	06HY033HLA011-CHASSIS	06W1D	16	WH							FRM GND			TSB	D	15.3.2004
	NULL	06HY033HLA012-01	06HY033HLA013-01	16	WH	1N						220VACN	06A550CB04		TSB	D	15.3.2004
	NULL	06HY033HLA012-03	06HY033HLA013-03	16	WH	1N						220VACN	06A550CB04		TSB	D	15.3.2004
	NULL	06HY033HLA012-04	06A807-TB POWER-08	16	BK	1N						220 VAC	06A550CB04		TSB	D	15.3.2004
	NULL	06HY033HLA012-CHASSIS	06W1D	16	WH							FRM GND			TSB	D	15.3.2004
	NULL	06HY033HLA013-01	06HY033HLA014-01	16	WH	1N						220VACN	06A550CB04		TSB	D	15.3.2004

coord	coord_	From	To	WC	CC	NC	IO	SC	Word	bit	remarks	power	origin	daisy_	ped	rev_le	write_date
	NULL	06HY033HLA013-03	06HY033HLA014-03	16	WH	1N						220VACN	06A550CB04		TSB	D	15.3.2004
	NULL	06HY033HLA013-04	06A807-TB POWER-10	16	BK	1N						220 VAC	06A550CB04		TSB	D	15.3.2004
	NULL	06HY033HLA013-CHASSIS	06W1D	16	WH							FRM GND			TSB	D	15.3.2004
	NULL	06HY033HLA014-01	06HY033HLA015-01	16	WH	1N						220VACN	06A550CB04		TSB	D	15.3.2004
	NULL	06HY033HLA014-03	06HY033HLA015-03	16	WH	1N						220VACN	06A550CB04		TSB	D	15.3.2004
	NULL	06HY033HLA014-04	06A807-TB POWER-12	16	BK	1N						220 VAC	06A550CB04		TSB	D	15.3.2004
	NULL	06HY033HLA014-CHASSIS	06W1D	16	WH							FRM GND			TSB	D	15.3.2004
	NULL	06HY033HLA015-01	06HY033HLA016-01	16	WH	1N						220VACN	06A550CB04		TSB	D	15.3.2004
	NULL	06HY033HLA015-03	06HY033HLA016-03	16	WH	1N						220VACN	06A550CB04		TSB	D	15.3.2004
	NULL	06HY033HLA015-04	06A807-TB POWER-14	16	BK	1N						220 VAC	06A550CB04		TSB	D	15.3.2004
	NULL	06HY033HLA015-CHASSIS	06W1D	16	WH							FRM GND			TSB	D	15.3.2004
	NULL	06HY033HLA016-01	06HY033HLA017-01	16	WH	1N						220VACN	06A550CB04		TSB	D	15.3.2004
	NULL	06HY033HLA016-03	06HY033HLA017-03	16	WH	1N						220VACN	06A550CB04		TSB	D	15.3.2004
	NULL	06HY033HLA016-04	06A807-TB POWER-16	16	BK	1N						220 VAC	06A550CB04		TSB	D	15.3.2004
	NULL	06HY033HLA016-CHASSIS	06W1D	16	WH							FRM GND			TSB	D	15.3.2004
	NULL	06HY033HLA017-01	06HY033HLA018-01	16	WH	1N						220VACN	06A550CB04		TSB	D	15.3.2004
	NULL	06HY033HLA017-03	06HY033HLA018-03	16	WH	1N						220VACN	06A550CB04		TSB	D	15.3.2004
	NULL	06HY033HLA017-04	06A807-TB POWER-18	16	BK	1N						220 VAC	06A550CB04		TSB	D	15.3.2004
	NULL	06HY033HLA017-CHASSIS	06W1D	16	WH							FRM GND			TSB	D	15.3.2004
	NULL	06HY033HLA018-01	06HY033HLA019-01	16	WH	1N						220VACN	06A550CB04		TSB	D	15.3.2004
	NULL	06HY033HLA018-03	06HY033HLA019-03	16	WH	1N						220VACN	06A550CB04		TSB	D	15.3.2004
	NULL	06HY033HLA018-04	06A807-TB POWER-20	16	BK	1N						220 VAC	06A550CB04		TSB	D	15.3.2004
	NULL	06HY033HLA018-CHASSIS	06W1D	16	WH							FRM GND			TSB	D	15.3.2004
	NULL	06HY033HLA019-01	06HY033HLA020-01	16	WH	1N						220VACN	06A550CB04		TSB	D	15.3.2004
	NULL	06HY033HLA019-03	06HY033HLA020-03	16	WH	1N						220VACN	06A550CB04		TSB	D	15.3.2004
	NULL	06HY033HLA019-04	06A807-TB POWER-22	16	BK	1N						220 VAC	06A550CB04		TSB	D	15.3.2004
	NULL	06HY033HLA019-CHASSIS	06W1D	16	WH							FRM GND			TSB	D	15.3.2004
	NULL	06HY033HLA020-01	06HY033HLA021-01	16	WH	1N						220VACN	06A550CB04		TSB	D	15.3.2004
	NULL	06HY033HLA020-03	06HY033HLA021-03	16	WH	1N						220VACN	06A550CB04		TSB	D	15.3.2004
	NULL	06HY033HLA020-04	06A807-TB POWER-24	16	BK	1N						220 VAC	06A550CB04		TSB	D	15.3.2004
	NULL	06HY033HLA020-CHASSIS	06W1D	16	WH							FRM GND			TSB	D	15.3.2004
	NULL	06HY033HLA021-01	06HY033HLA022-01	16	WH	1N						220VACN	06A550CB04		TSB	D	15.3.2004
	NULL	06HY033HLA021-03	06HY033HLA022-03	16	WH	1N						220VACN	06A550CB04		TSB	D	15.3.2004
	NULL	06HY033HLA021-04	06A807-TB POWER-26	16	BK	1N						220 VAC	06A550CB04		TSB	D	15.3.2004
	NULL	06HY033HLA021-CHASSIS	06W1D	16	WH							FRM GND			TSB	D	15.3.2004
	NULL	06HY033HLA022-01	06HY033HLA023-01	16	WH	1N						220VACN	06A550CB04		TSB	D	15.3.2004
	NULL	06HY033HLA022-03	06HY033HLA023-03	16	WH	1N						220VACN	06A550CB04		TSB	D	15.3.2004
	NULL	06HY033HLA022-04	06A807-TB POWER-28	16	BK	1N						220 VAC	06A550CB04		TSB	D	15.3.2004
	NULL	06HY033HLA022-CHASSIS	06W1D	16	WH							FRM GND			TSB	D	15.3.2004
	NULL	06HY033HLA023-01	06HY033HLA024-01	16	WH	1N						220VACN	06A550CB04		TSB	D	15.3.2004
	NULL	06HY033HLA023-03	06HY033HLA024-03	16	WH	1N						220VACN	06A550CB04		TSB	D	15.3.2004
	NULL	06HY033HLA023-04	06A807-TB POWER-30	16	BK	1N						220 VAC	06A550CB04		TSB	D	15.3.2004
	NULL	06HY033HLA023-CHASSIS	06W1E	16	WH							FRM GND			TSB	D	15.3.2004
	NULL	06HY033HLA024-01	06HY033HLA025-01	16	WH	1N						220VACN	06A550CB04		TSB	D	15.3.2004
	NULL	06HY033HLA024-03	06HY033HLA025-03	16	WH	1N						220VACN	06A550CB04		TSB	D	15.3.2004
	NULL	06HY033HLA024-04	06A807-TB POWER-32	16	BK	1N						220 VAC	06A550CB04		TSB	D	15.3.2004
	NULL	06HY033HLA024-CHASSIS	06W1E	16	WH							FRM GND			TSB	D	15.3.2004
	NULL	06HY033HLA025-01	06HY033HLA026-01	16	WH	1N						220VACN	06A550CB04		TSB	D	15.3.2004
	NULL	06HY033HLA025-03	06HY033HLA026-03	16	WH	1N						220VACN	06A550CB04		TSB	D	15.3.2004
	NULL	06HY033HLA025-04	06A808-TB POWER-02	16	BK	1N						220 VAC	06A550CB04		TSB	D	15.3.2004
	NULL	06HY033HLA025-CHASSIS	06W1E	16	WH							FRM GND			TSB	D	15.3.2004
	NULL	06HY033HLA026-01	06HY033HLA027-01	16	WH	1N						220VACN	06A550CB04		TSB	D	15.3.2004
	NULL	06HY033HLA026-03	06HY033HLA027-03	16	WH	1N						220VACN	06A550CB04		TSB	D	15.3.2004
	NULL	06HY033HLA026-04	06A808-TB POWER-04	16	BK	1N						220 VAC	06A550CB04		TSB	D	15.3.2004

coord	coord_	From	To	WC	CC	NC	IO	SC	Word	bit	remarks	power	origin	daisy_	ped	rev_le	write_date
	NULL	06HY033HLA026-CHASSIS	06W1E	16	WH							FRM GND			TSB	D	15.3.2004
	NULL	06HY033HLA027-01	06HY033HLA028-01	16	WH	1N						220VACN	06A550CB04		TSB	D	15.3.2004
	NULL	06HY033HLA027-03	06HY033HLA028-03	16	WH	1N						220VACN	06A550CB04		TSB	D	15.3.2004
	NULL	06HY033HLA027-04	06A808-TB POWER-06	16	BK	1N						220 VAC	06A550CB04		TSB	D	15.3.2004
	NULL	06HY033HLA027-CHASSIS	06W1E	16	WH							FRM GND			TSB	D	15.3.2004
	NULL	06HY033HLA028-01	06HY033HLA029-01	16	WH	1N						220VACN	06A550CB04		TSB	D	15.3.2004
	NULL	06HY033HLA028-03	06HY033HLA029-03	16	WH	1N						220VACN	06A550CB04		TSB	D	15.3.2004
	NULL	06HY033HLA028-04	06A808-TB POWER-08	16	BK	1N						220 VAC	06A550CB04		TSB	D	15.3.2004
	NULL	06HY033HLA028-CHASSIS	06W1E	16	WH							FRM GND			TSB	D	15.3.2004
	NULL	06HY033HLA029-01	06HY033HLA030-01	16	WH	1N						220VACN	06A550CB04		TSB	D	15.3.2004
	NULL	06HY033HLA029-03	06HY033HLA030-03	16	WH	1N						220VACN	06A550CB04		TSB	D	15.3.2004
	NULL	06HY033HLA029-04	06A808-TB POWER-10	16	BK	1N						220 VAC	06A550CB04		TSB	D	15.3.2004
	NULL	06HY033HLA029-CHASSIS	06W1E	16	WH							FRM GND			TSB	D	15.3.2004
	NULL	06HY033HLA030-01	06HY033HLA031-01	16	WH	1N						220VACN	06A550CB04		TSB	D	15.3.2004
	NULL	06HY033HLA030-03	06HY033HLA031-03	16	WH	1N						220VACN	06A550CB04		TSB	D	15.3.2004
	NULL	06HY033HLA030-04	06A808-TB POWER-12	16	BK	1N						220 VAC	06A550CB04		TSB	D	15.3.2004
	NULL	06HY033HLA030-CHASSIS	06W1E	16	WH							FRM GND			TSB	D	15.3.2004
	NULL	06HY033HLA031-01	06HY033HLA032-01	16	WH	1N						220VACN	06A550CB04		TSB	D	15.3.2004
	NULL	06HY033HLA031-03	06HY033HLA032-03	16	WH	1N						220VACN	06A550CB04		TSB	D	15.3.2004
	NULL	06HY033HLA031-04	06A808-TB POWER-14	16	BK	1N						220 VAC	06A550CB04		TSB	D	15.3.2004
	NULL	06HY033HLA031-CHASSIS	06W1E	16	WH							FRM GND			TSB	D	15.3.2004
	NULL	06HY033HLA032-01	06HY033HLA033-01	16	WH	1N						220VACN	06A550CB04		TSB	D	15.3.2004
	NULL	06HY033HLA032-03	06HY033HLA033-03	16	WH	1N						220VACN	06A550CB04		TSB	D	15.3.2004
	NULL	06HY033HLA032-04	06A808-TB POWER-16	16	BK	1N						220 VAC	06A550CB04		TSB	D	15.3.2004
	NULL	06HY033HLA032-CHASSIS	06W1E	16	WH							FRM GND			TSB	D	15.3.2004
	NULL	06HY033HLA033-01	06HY033HLA034-01	16	WH	1N						220VACN	06A550CB04		TSB	D	15.3.2004
	NULL	06HY033HLA033-03	06HY033HLA034-03	16	WH	1N						220VACN	06A550CB04		TSB	D	15.3.2004
	NULL	06HY033HLA033-04	06A808-TB POWER-18	16	BK	1N						220 VAC	06A550CB04		TSB	D	15.3.2004
	NULL	06HY033HLA033-CHASSIS	06W1E	16	WH							FRM GND			TSB	D	15.3.2004
	NULL	06HY033HLA034-01	06HY033HLA035-01	16	WH	1N						220VACN	06A550CB04		TSB	D	15.3.2004
	NULL	06HY033HLA034-03	06HY033HLA035-03	16	WH	1N						220VACN	06A550CB04		TSB	D	15.3.2004
	NULL	06HY033HLA034-04	06A808-TB POWER-20	16	BK	1N						220 VAC	06A550CB04		TSB	D	15.3.2004
	NULL	06HY033HLA034-CHASSIS	06W1E	16	WH							FRM GND			TSB	D	15.3.2004
	NULL	06HY033HLA035-01	06HY033HLA036-01	16	WH	1N						220VACN	06A550CB04		TSB	D	15.3.2004
	NULL	06HY033HLA035-03	06HY033HLA036-03	16	WH	1N						220VACN	06A550CB04		TSB	D	15.3.2004
	NULL	06HY033HLA035-04	06A808-TB POWER-22	16	BK	1N						220 VAC	06A550CB04		TSB	D	15.3.2004
	NULL	06HY033HLA035-CHASSIS	06W1E	16	WH							FRM GND			TSB	D	15.3.2004
	NULL	06HY033HLA036-01	06HY033HLA037-01	16	WH	1N						220VACN	06A550CB04		TSB	D	15.3.2004
	NULL	06HY033HLA036-03	06HY033HLA037-03	16	WH	1N						220VACN	06A550CB04		TSB	D	15.3.2004
	NULL	06HY033HLA036-04	06A808-TB POWER-24	16	BK	1N						220 VAC	06A550CB04		TSB	D	15.3.2004
	NULL	06HY033HLA036-CHASSIS	06W1E	16	WH							FRM GND			TSB	D	15.3.2004
	NULL	06HY033HLA037-01	06HY033HLA038-01	16	WH	1N						220VACN	06A550CB04		TSB	D	15.3.2004
	NULL	06HY033HLA037-03	06HY033HLA038-03	16	WH	1N						220VACN	06A550CB04		TSB	D	15.3.2004
	NULL	06HY033HLA037-04	06A808-TB POWER-26	16	BK	1N						220 VAC	06A550CB04		TSB	D	15.3.2004
	NULL	06HY033HLA037-CHASSIS	06W1E	16	WH							FRM GND			TSB	D	15.3.2004
	NULL	06HY033HLA038-01	06HY033HLA039-01	16	WH	1N						220VACN	06A550CB04		TSB	D	15.3.2004
	NULL	06HY033HLA038-03	06HY033HLA039-03	16	WH	1N						220VACN	06A550CB04		TSB	D	15.3.2004
	NULL	06HY033HLA038-04	06A808-TB POWER-28	16	BK	1N						220 VAC	06A550CB04		TSB	D	15.3.2004
	NULL	06HY033HLA038-CHASSIS	06W1E	16	WH							FRM GND			TSB	D	15.3.2004
	NULL	06HY033HLA039-01	06HY033HLA040-01	16	WH	1N						220VACN	06A550CB04		TSB	D	15.3.2004
	NULL	06HY033HLA039-03	06HY033HLA040-03	16	WH	1N						220VACN	06A550CB04		TSB	D	15.3.2004
	NULL	06HY033HLA039-04	06A808-TB POWER-30	16	BK	1N						220 VAC	06A550CB04		TSB	D	15.3.2004
	NULL	06HY033HLA039-CHASSIS	06W1E	16	WH							FRM GND			TSB	D	15.3.2004
	NULL	06HY033HLA040-01	06HY033HLA041-01	16	WH	1N						220VACN	06A550CB04		TSB	D	15.3.2004

coord	coord_	From	To	WC	CC	NC	IO	SC	Word	bit	remarks	power	origin	daisy_	ped	rev_le	write_date
	NULL	06HY033HLA040-03	06HY033HLA041-03	16	WH	1N						220VACN	06A550CB04		TSB	D	15.3.2004
	NULL	06HY033HLA040-04	06A808-TB POWER-32	16	BK	1N						220 VAC	06A550CB04		TSB	D	15.3.2004
	NULL	06HY033HLA040-CHASSIS	06W1E	16	WH							FRM GND			TSB	D	15.3.2004
	NULL	06HY033HLA041-01	06HY033HLA042-01	16	WH	1N						220VACN	06A550CB04		TSB	D	15.3.2004
	NULL	06HY033HLA041-03	06HY033HLA042-03	16	WH	1N						220VACN	06A550CB04		TSB	D	15.3.2004
	NULL	06HY033HLA041-04	06A809-TB POWER-02	16	BK	1N						220 VAC	06A550CB04		TSB	D	15.3.2004
	NULL	06HY033HLA041-CHASSIS	06W1E	16	WH							FRM GND			TSB	D	15.3.2004
	NULL	06HY033HLA042-01	06HY033HLA043-01	16	WH	1N						220VACN	06A550CB04		TSB	D	15.3.2004
	NULL	06HY033HLA042-03	06HY033HLA043-03	16	WH	1N						220VACN	06A550CB04		TSB	D	15.3.2004
	NULL	06HY033HLA042-04	06A813-TB POWER-22	16	BK	1N						220 VAC	06A550CB10		TSB	D	15.3.2004
	NULL	06HY033HLA042-CHASSIS	06W1H	16	WH							FRM GND			TSB	D	15.3.2004
	NULL	06HY033HLA043-01	06HY033HLA044-01	16	WH	1N						220VACN	06A550CB04		TSB	D	15.3.2004
	NULL	06HY033HLA043-03	06HY033HLA044-03	16	WH	1N						220VACN	06A550CB04		TSB	D	15.3.2004
	NULL	06HY033HLA043-04	06A813-TB POWER-24	16	BK	1N						220 VAC	06A550CB10		TSB	D	15.3.2004
	NULL	06HY033HLA043-CHASSIS	06W1H	16	WH							FRM GND			TSB	D	15.3.2004
	NULL	06HY033HLA044-01	06HY033HLA045-01	16	WH	1N						220VACN	06A550CB04		TSB	D	15.3.2004
	NULL	06HY033HLA044-03	06HY033HLA045-03	16	WH	1N						220VACN	06A550CB04		TSB	D	15.3.2004
	NULL	06HY033HLA044-04	06A809-TB POWER-16	16	BK	1N						220 VAC	06A550CB04		TSB	D	15.3.2004
	NULL	06HY033HLA044-CHASSIS	06W1H	16	WH							FRM GND			TSB	D	15.3.2004
	NULL	06HY033HLA045-01	06HY033HLA046-01	16	WH	1N						220VACN	06A550CB04		TSB	D	15.3.2004
	NULL	06HY033HLA045-03	06HY033HLA046-03	16	WH	1N						220VACN	06A550CB04		TSB	D	15.3.2004
	NULL	06HY033HLA045-04	06A809-TB POWER-18	16	BK	1N						220 VAC	06A550CB04		TSB	D	15.3.2004
	NULL	06HY033HLA045-CHASSIS	06W1D	16	WH							FRM GND			TSB	D	15.3.2004
	NULL	06HY033HLA046-01	06HY033HLA047-01	16	WH	1N						220VACN	06A550CB04		TSB	D	15.3.2004
	NULL	06HY033HLA046-03	06HY033HLA047-03	16	WH	1N						220VACN	06A550CB04		TSB	D	15.3.2004
	NULL	06HY033HLA046-04	06A809-TB POWER-20	16	BK	1N						220 VAC	06A550CB04		TSB	D	15.3.2004
	NULL	06HY033HLA046-CHASSIS	06W1D	16	WH							FRM GND			TSB	D	15.3.2004
	NULL	06HY033HLA047-01	06HY033HLA048-01	16	WH	1N						220VACN	06A550CB04		TSB	D	15.3.2004
	NULL	06HY033HLA047-03	06HY033HLA048-03	16	WH	1N						220VACN	06A550CB04		TSB	D	15.3.2004
	NULL	06HY033HLA047-04	06A809-TB POWER-22	16	BK	1N						220 VAC	06A550CB04		TSB	D	15.3.2004
	NULL	06HY033HLA047-CHASSIS	06W1D	16	WH							FRM GND			TSB	D	15.3.2004
	NULL	06HY033HLA048-01	06HY033HLA049-01	16	WH	1N						220VACN	06A550CB04		TSB	D	15.3.2004
	NULL	06HY033HLA048-03	06HY033HLA049-03	16	WH	1N						220VACN	06A550CB04		TSB	D	15.3.2004
	NULL	06HY033HLA048-04	06A809-TB POWER-24	16	BK	1N						220 VAC	06A550CB04		TSB	D	15.3.2004
	NULL	06HY033HLA048-CHASSIS	06W1D	16	WH							FRM GND			TSB	D	15.3.2004
	NULL	06HY033HLA049-01	06HY033HLA050-01	16	WH	1N						220VACN	06A550CB04		TSB	D	15.3.2004
	NULL	06HY033HLA049-03	06HY033HLA050-03	16	WH	1N						220VACN	06A550CB04		TSB	D	15.3.2004
	NULL	06HY033HLA049-04	06A809-TB POWER-26	16	BK	1N						220 VAC	06A550CB04		TSB	D	15.3.2004
	NULL	06HY033HLA049-CHASSIS	06W1D	16	WH							FRM GND			TSB	D	15.3.2004
	NULL	06HY033HLA050-01	06HY033HLA051-01	16	WH	1N						220VACN	06A550CB04		TSB	D	15.3.2004
	NULL	06HY033HLA050-03	06HY033HLA051-03	16	WH	1N						220VACN	06A550CB04		TSB	D	15.3.2004
	NULL	06HY033HLA050-04	06A809-TB POWER-28	16	BK	1N						220 VAC	06A550CB04		TSB	D	15.3.2004
	NULL	06HY033HLA050-CHASSIS	06W1D	16	WH							FRM GND			TSB	D	15.3.2004
	NULL	06HY033HLA051-01	06HY033HLA052-01	16	WH	1N						220VACN	06A550CB04		TSB	D	15.3.2004
	NULL	06HY033HLA051-03	06HY033HLA052-03	16	WH	1N						220VACN	06A550CB04		TSB	D	15.3.2004
	NULL	06HY033HLA051-04	06A809-TB POWER-30	16	BK	1N						220 VAC	06A550CB04		TSB	D	15.3.2004
	NULL	06HY033HLA051-CHASSIS	06W1D	16	WH							FRM GND			TSB	D	15.3.2004
	NULL	06HY033HLA052-04	06A809-TB POWER-32	16	BK	1N						220 VAC	06A550CB04		TSB	D	15.3.2004
	NULL	06HY033HLA052-CHASSIS	06W1D	16	WH							FRM GND			TSB	D	15.3.2004
	NULL	06HY033HLA053-01	06A681-K04-05	16	WH	1N						220VACN	06A550CB04		TSB	D	15.3.2004
	NULL	06HY033HLA053-01	06HY033HLA054-01	16	WH	1N						220VACN	06A550CB04		TSB	D	15.3.2004
	NULL	06HY033HLA053-03	06A680-K11-NC	16	WH	1N						220VACN	06A550CB04		TSB	D	15.3.2004
	NULL	06HY033HLA053-03	06HY033HLA054-03	16	WH	1N						220VACN	06A550CB04		TSB	D	15.3.2004
	NULL	06HY033HLA053-04	06A812-TB POWER-02	16	BK	1N						220 VAC	06A550CB04		TSB	D	15.3.2004

coord	coord_	From	To	WC	CC	NC	IO	SC	Word	bit	remarks	power	origin	daisy_	ped	rev_le	write_date
	NULL	06HY033HLA053-CHASSIS	06W1D	16	WH							FRM GND			TSB	D	15.3.2004
	NULL	06HY033HLA054-01	06HY033HLA055-01	16	WH	1N						220VACN	06A550CB04		TSB	D	15.3.2004
	NULL	06HY033HLA054-03	06HY033HLA055-03	16	WH	1N						220VACN	06A550CB04		TSB	D	15.3.2004
	NULL	06HY033HLA054-04	06A812-TB POWER-04	16	BK	1N						220 VAC	06A550CB04		TSB	D	15.3.2004
	NULL	06HY033HLA054-CHASSIS	06W1D	16	WH							FRM GND			TSB	D	15.3.2004
	NULL	06HY033HLA055-01	06HY033HLA056-01	16	WH	1N						220VACN	06A550CB04		TSB	D	15.3.2004
	NULL	06HY033HLA055-03	06HY033HLA056-03	16	WH	1N						220VACN	06A550CB04		TSB	D	15.3.2004
	NULL	06HY033HLA055-04	06A812-TB POWER-06	16	BK	1N						220 VAC	06A550CB04		TSB	D	15.3.2004
	NULL	06HY033HLA055-CHASSIS	06W1D	16	WH							FRM GND			TSB	D	15.3.2004
	NULL	06HY033HLA056-01	06HY033HLA057-01	16	WH	1N						220VACN	06A550CB04		TSB	D	15.3.2004
	NULL	06HY033HLA056-03	06HY033HLA057-03	16	WH	1N						220VACN	06A550CB04		TSB	D	15.3.2004
	NULL	06HY033HLA056-04	06A812-TB POWER-08	16	BK	1N						220 VAC	06A550CB04		TSB	D	15.3.2004
	NULL	06HY033HLA056-CHASSIS	06W1D	16	WH							FRM GND			TSB	D	15.3.2004
	NULL	06HY033HLA057-01	06HY033HLA058-01	16	WH	1N						220VACN	06A550CB04		TSB	D	15.3.2004
	NULL	06HY033HLA057-03	06HY033HLA058-03	16	WH	1N						220VACN	06A550CB04		TSB	D	15.3.2004
	NULL	06HY033HLA057-04	06A812-TB POWER-10	16	BK	1N						220 VAC	06A550CB04		TSB	D	15.3.2004
	NULL	06HY033HLA057-CHASSIS	06W1D	16	WH							FRM GND			TSB	D	15.3.2004
	NULL	06HY033HLA058-01	06HY033HLA059-01	16	WH	1N						220VACN	06A550CB04		TSB	D	15.3.2004
	NULL	06HY033HLA058-03	06HY033HLA059-03	16	WH	1N						220VACN	06A550CB04		TSB	D	15.3.2004
	NULL	06HY033HLA058-04	06A812-TB POWER-12	16	BK	1N						220 VAC	06A550CB04		TSB	D	15.3.2004
	NULL	06HY033HLA058-CHASSIS	06W1D	16	WH							FRM GND			TSB	D	15.3.2004
	NULL	06HY033HLA059-01	06HY033HLA060-01	16	WH	1N						220VACN	06A550CB04		TSB	D	15.3.2004
	NULL	06HY033HLA059-03	06HY033HLA060-03	16	WH	1N						220VACN	06A550CB04		TSB	D	15.3.2004
	NULL	06HY033HLA059-04	06A812-TB POWER-14	16	BK	1N						220 VAC	06A550CB04		TSB	D	15.3.2004
	NULL	06HY033HLA059-CHASSIS	06W1D	16	WH							FRM GND			TSB	D	15.3.2004
	NULL	06HY033HLA060-01	06HY033HLA061-01	16	WH	1N						220VACN	06A550CB04		TSB	D	15.3.2004
	NULL	06HY033HLA060-03	06HY033HLA061-03	16	WH	1N						220VACN	06A550CB04		TSB	D	15.3.2004
	NULL	06HY033HLA060-04	06A812-TB POWER-16	16	BK	1N						220 VAC	06A550CB04		TSB	D	15.3.2004
	NULL	06HY033HLA060-CHASSIS	06W1D	16	WH							FRM GND			TSB	D	15.3.2004
	NULL	06HY033HLA061-01	06HY033HLA062-01	16	WH	1N						220VACN	06A550CB04		TSB	D	15.3.2004
	NULL	06HY033HLA061-03	06HY033HLA062-03	16	WH	1N						220VACN	06A550CB04		TSB	D	15.3.2004
	NULL	06HY033HLA061-04	06A812-TB POWER-18	16	BK	1N						220 VAC	06A550CB04		TSB	D	15.3.2004
	NULL	06HY033HLA061-CHASSIS	06W1D	16	WH							FRM GND			TSB	D	15.3.2004
	NULL	06HY033HLA062-01	06HY033HLA063-01	16	WH	1N						220VACN	06A550CB04		TSB	D	15.3.2004
	NULL	06HY033HLA062-03	06HY033HLA063-03	16	WH	1N						220VACN	06A550CB04		TSB	D	15.3.2004
	NULL	06HY033HLA062-04	06A812-TB POWER-20	16	BK	1N						220 VAC	06A550CB04		TSB	D	15.3.2004
	NULL	06HY033HLA062-CHASSIS	06W1D	16	WH							FRM GND			TSB	D	15.3.2004
	NULL	06HY033HLA063-01	06HY033HLA064-01	16	WH	1N						220VACN	06A550CB04		TSB	D	15.3.2004
	NULL	06HY033HLA063-03	06HY033HLA064-03	16	WH	1N						220VACN	06A550CB04		TSB	D	15.3.2004
	NULL	06HY033HLA063-04	06A812-TB POWER-22	16	BK	1N						220 VAC	06A550CB04		TSB	D	15.3.2004
	NULL	06HY033HLA063-CHASSIS	06W1E	16	WH							FRM GND			TSB	D	15.3.2004
	NULL	06HY033HLA064-01	06HY033HLA065-01	16	WH	1N						220VACN	06A550CB04		TSB	D	15.3.2004
	NULL	06HY033HLA064-03	06HY033HLA065-03	16	WH	1N						220VACN	06A550CB04		TSB	D	15.3.2004
	NULL	06HY033HLA064-04	06A812-TB POWER-24	16	BK	1N						220 VAC	06A550CB04		TSB	D	15.3.2004
	NULL	06HY033HLA064-CHASSIS	06W1E	16	WH							FRM GND			TSB	D	15.3.2004
	NULL	06HY033HLA065-01	06HY033HLA066-01	16	WH	1N						220VACN	06A550CB04		TSB	D	15.3.2004
	NULL	06HY033HLA065-03	06HY033HLA066-03	16	WH	1N						220VACN	06A550CB04		TSB	D	15.3.2004
	NULL	06HY033HLA065-04	06A812-TB POWER-26	16	BK	1N						220 VAC	06A550CB04		TSB	D	15.3.2004
	NULL	06HY033HLA065-CHASSIS	06W1E	16	WH							FRM GND			TSB	D	15.3.2004
	NULL	06HY033HLA066-01	06HY033HLA067-01	16	WH	1N						220VACN	06A550CB04		TSB	D	15.3.2004
	NULL	06HY033HLA066-03	06HY033HLA067-03	16	WH	1N						220VACN	06A550CB04		TSB	D	15.3.2004
	NULL	06HY033HLA066-04	06A812-TB POWER-28	16	BK	1N						220 VAC	06A550CB04		TSB	D	15.3.2004
	NULL	06HY033HLA066-CHASSIS	06W1E	16	WH							FRM GND			TSB	D	15.3.2004
	NULL	06HY033HLA067-01	06HY033HLA068-01	16	WH	1N						220VACN	06A550CB04		TSB	D	15.3.2004

coord	coord_	From	To	WC	CC	NC	IO	SC	Word	bit	remarks	power	origin	daisy_	ped	rev_le	write_date
	NULL	06HY033HLA067-03	06HY033HLA068-03	16	WH	1N						220VACN	06A550CB04		TSB	D	15.3.2004
	NULL	06HY033HLA067-04	06A812-TB POWER-30	16	BK	1N						220 VAC	06A550CB04		TSB	D	15.3.2004
	NULL	06HY033HLA067-CHASSIS	06W1E	16	WH							FRM GND			TSB	D	15.3.2004
	NULL	06HY033HLA068-01	06HY033HLA069-01	16	WH	1N						220VACN	06A550CB04		TSB	D	15.3.2004
	NULL	06HY033HLA068-03	06HY033HLA069-03	16	WH	1N						220VACN	06A550CB04		TSB	D	15.3.2004
	NULL	06HY033HLA068-04	06A812-TB POWER-32	16	BK	1N						220 VAC	06A550CB04		TSB	D	15.3.2004
	NULL	06HY033HLA068-CHASSIS	06W1E	16	WH							FRM GND			TSB	D	15.3.2004
	NULL	06HY033HLA069-01	06HY033HLA070-01	16	WH	1N						220VACN	06A550CB04		TSB	D	15.3.2004
	NULL	06HY033HLA069-03	06HY033HLA070-03	16	WH	1N						220VACN	06A550CB04		TSB	D	15.3.2004
	NULL	06HY033HLA069-04	06A813-TB POWER-02	16	BK	1N						220 VAC	06A550CB10		TSB	D	15.3.2004
	NULL	06HY033HLA069-CHASSIS	06W1E	16	WH							FRM GND			TSB	D	15.3.2004
	NULL	06HY033HLA070-01	06HY033HLA071-01	16	WH	1N						220VACN	06A550CB04		TSB	D	15.3.2004
	NULL	06HY033HLA070-03	06HY033HLA071-03	16	WH	1N						220VACN	06A550CB04		TSB	D	15.3.2004
	NULL	06HY033HLA070-04	06A813-TB POWER-04	16	BK	1N						220 VAC	06A550CB10		TSB	D	15.3.2004
	NULL	06HY033HLA070-CHASSIS	06W1E	16	WH							FRM GND			TSB	D	15.3.2004
	NULL	06HY033HLA071-01	06HY033HLA072-01	16	WH	1N						220VACN	06A550CB04		TSB	D	15.3.2004
	NULL	06HY033HLA071-03	06HY033HLA072-03	16	WH	1N						220VACN	06A550CB04		TSB	D	15.3.2004
	NULL	06HY033HLA071-04	06A813-TB POWER-06	16	BK	1N						220 VAC	06A550CB10		TSB	D	15.3.2004
	NULL	06HY033HLA071-CHASSIS	06W1E	16	WH							FRM GND			TSB	D	15.3.2004
	NULL	06HY033HLA072-01	06HY033HLA073-01	16	WH	1N						220VACN	06A550CB04		TSB	D	15.3.2004
	NULL	06HY033HLA072-03	06HY033HLA073-03	16	WH	1N						220VACN	06A550CB04		TSB	D	15.3.2004
	NULL	06HY033HLA072-04	06A813-TB POWER-08	16	BK	1N						220 VAC	06A550CB10		TSB	D	15.3.2004
	NULL	06HY033HLA072-CHASSIS	06W1E	16	WH							FRM GND			TSB	D	15.3.2004
	NULL	06HY033HLA073-01	06HY033HLA074-01	16	WH	1N						220VACN	06A550CB04		TSB	D	15.3.2004
	NULL	06HY033HLA073-03	06HY033HLA074-03	16	WH	1N						220VACN	06A550CB04		TSB	D	15.3.2004
	NULL	06HY033HLA073-04	06A813-TB POWER-10	16	BK	1N						220 VAC	06A550CB10		TSB	D	15.3.2004
	NULL	06HY033HLA073-CHASSIS	06W1E	16	WH							FRM GND			TSB	D	15.3.2004
	NULL	06HY033HLA074-01	06HY033HLA075-01	16	WH	1N						220VACN	06A550CB04		TSB	D	15.3.2004
	NULL	06HY033HLA074-03	06HY033HLA075-03	16	WH	1N						220VACN	06A550CB04		TSB	D	15.3.2004
	NULL	06HY033HLA074-04	06A813-TB POWER-12	16	BK	1N						220 VAC	06A550CB10		TSB	D	15.3.2004
	NULL	06HY033HLA074-CHASSIS	06W1E	16	WH							FRM GND			TSB	D	15.3.2004
	NULL	06HY033HLA075-01	06HY033HLA076-01	16	WH	1N						220VACN	06A550CB04		TSB	D	15.3.2004
	NULL	06HY033HLA075-03	06HY033HLA076-03	16	WH	1N						220VACN	06A550CB04		TSB	D	15.3.2004
	NULL	06HY033HLA075-04	06A813-TB POWER-14	16	BK	1N						220 VAC	06A550CB10		TSB	D	15.3.2004
	NULL	06HY033HLA075-CHASSIS	06W1E	16	WH							FRM GND			TSB	D	15.3.2004
	NULL	06HY033HLA076-01	06HY033HLA077-01	16	WH	1N						220VACN	06A550CB04		TSB	D	15.3.2004
	NULL	06HY033HLA076-03	06HY033HLA077-03	16	WH	1N						220VACN	06A550CB04		TSB	D	15.3.2004
	NULL	06HY033HLA076-04	06A813-TB POWER-16	16	BK	1N						220 VAC	06A550CB10		TSB	D	15.3.2004
	NULL	06HY033HLA076-CHASSIS	06W1E	16	WH							FRM GND			TSB	D	15.3.2004
	NULL	06HY033HLA077-01	06HY033HLA078-01	16	WH	1N						220VACN	06A550CB04		TSB	D	15.3.2004
	NULL	06HY033HLA077-03	06HY033HLA078-03	16	WH	1N						220VACN	06A550CB04		TSB	D	15.3.2004
	NULL	06HY033HLA077-04	06A813-TB POWER-18	16	BK	1N						220 VAC	06A550CB10		TSB	D	15.3.2004
	NULL	06HY033HLA077-CHASSIS	06W1E	16	WH							FRM GND			TSB	D	15.3.2004
	NULL	06HY033HLA078-04	06A813-TB POWER-20	16	BK	1N						220 VAC	06A550CB10		TSB	D	15.3.2004
	NULL	06HY033HLA078-CHASSIS	06W1E	16	WH							FRM GND			TSB	D	15.3.2004
	NULL	06A806-TB SIGNAL-18	06A530-A2P09-09	22	WH		LO	1	006	08	06HY033HLA001				TSB		15.3.2004
	NULL	06A806-TB SIGNAL-20	06A530-A2P09-10	22	WH		LO	1	006	09	06HY033HLA002				TSB		15.3.2004
	NULL	06A806-TB SIGNAL-22	06A530-A2P09-11	22	WH		LO	1	006	10	06HY033HLA003				TSB		15.3.2004
	NULL	06A806-TB SIGNAL-24	06A530-A2P09-12	22	WH		LO	1	006	11	06HY033HLA004				TSB		15.3.2004
	NULL	06A806-TB SIGNAL-26	06A530-A2P09-13	22	WH		LO	1	006	12	06HY033HLA005				TSB		15.3.2004
	NULL	06A806-TB SIGNAL-28	06A530-A2P09-14	22	WH		LO	1	006	13	06HY033HLA006				TSB		15.3.2004
	NULL	06A806-TB SIGNAL-30	06A530-A2P09-15	22	WH		LO	1	006	14	06HY033HLA007				TSB		15.3.2004
	NULL	06A806-TB SIGNAL-32	06A530-A2P09-16	22	WH		LO	1	006	15	06HY033HLA008				TSB		15.3.2004
	NULL	06A807-TB SIGNAL-02	06A530-A2P10-01	22	WH		LO	1	007	00	06HY033HLA009				TSB		15.3.2004

coord	coord_	From	To	WC	CC	NC	IO	SC	Word	bit	remarks	power	origin	daisy_	ped	rev_le	write_date
	NULL	06A807-TB SIGNAL-04	06A530-A2P10-02	22	WH		LO	1	007	01	06HY033HLA010				TSB		15.3.2004
	NULL	06A807-TB SIGNAL-06	06A530-A2P10-03	22	WH		LO	1	007	02	06HY033HLA011				TSB		15.3.2004
	NULL	06A807-TB SIGNAL-08	06A530-A2P10-04	22	WH		LO	1	007	03	06HY033HLA012				TSB		15.3.2004
	NULL	06A807-TB SIGNAL-10	06A530-A2P10-05	22	WH		LO	1	007	04	06HY033HLA013				TSB		15.3.2004
	NULL	06A807-TB SIGNAL-12	06A530-A2P10-06	22	WH		LO	1	007	05	06HY033HLA014				TSB		15.3.2004
	NULL	06A807-TB SIGNAL-14	06A530-A2P10-07	22	WH		LO	1	007	06	06HY033HLA015				TSB		15.3.2004
	NULL	06A807-TB SIGNAL-16	06A530-A2P10-08	22	WH		LO	1	007	07	06HY033HLA016				TSB		15.3.2004
	NULL	06A807-TB SIGNAL-18	06A530-A2P10-09	22	WH		LO	1	007	08	06HY033HLA017				TSB		15.3.2004
	NULL	06A807-TB SIGNAL-20	06A530-A2P10-10	22	WH		LO	1	007	09	06HY033HLA018				TSB		15.3.2004
	NULL	06A807-TB SIGNAL-22	06A530-A2P10-11	22	WH		LO	1	007	10	06HY033HLA019				TSB		15.3.2004
	NULL	06A807-TB SIGNAL-24	06A530-A2P10-12	22	WH		LO	1	007	11	06HY033HLA020				TSB		15.3.2004
	NULL	06A807-TB SIGNAL-26	06A530-A2P10-13	22	WH		LO	1	007	12	06HY033HLA021				TSB		15.3.2004
	NULL	06A807-TB SIGNAL-28	06A530-A2P10-14	22	WH		LO	1	007	13	06HY033HLA022				TSB		15.3.2004
	NULL	06A807-TB SIGNAL-30	06A530-A2P10-15	22	WH		LO	1	007	14	06HY033HLA023				TSB		15.3.2004
	NULL	06A807-TB SIGNAL-32	06A530-A2P10-16	22	WH		LO	1	007	15	06HY033HLA024				TSB		15.3.2004
	NULL	06A808-TB SIGNAL-02	06A530-A2P11-01	22	WH		LO	1	008	00	06HY033HLA025				TSB		15.3.2004
	NULL	06A808-TB SIGNAL-04	06A530-A2P11-02	22	WH		LO	1	008	01	06HY033HLA026				TSB		15.3.2004
	NULL	06A808-TB SIGNAL-06	06A530-A2P11-03	22	WH		LO	1	008	02	06HY033HLA027				TSB		15.3.2004
	NULL	06A808-TB SIGNAL-08	06A530-A2P11-04	22	WH		LO	1	008	03	06HY033HLA028				TSB		15.3.2004
	NULL	06A808-TB SIGNAL-10	06A530-A2P11-05	22	WH		LO	1	008	04	06HY033HLA029				TSB		15.3.2004
	NULL	06A808-TB SIGNAL-12	06A530-A2P11-06	22	WH		LO	1	008	05	06HY033HLA030				TSB		15.3.2004
	NULL	06A808-TB SIGNAL-14	06A530-A2P11-07	22	WH		LO	1	008	06	06HY033HLA031				TSB		15.3.2004
	NULL	06A808-TB SIGNAL-16	06A530-A2P11-08	22	WH		LO	1	008	07	06HY033HLA032				TSB		15.3.2004
	NULL	06A808-TB SIGNAL-18	06A530-A2P11-09	22	WH		LO	1	008	08	06HY033HLA033				TSB		15.3.2004
	NULL	06A808-TB SIGNAL-20	06A530-A2P11-10	22	WH		LO	1	008	09	06HY033HLA034				TSB		15.3.2004
	NULL	06A808-TB SIGNAL-22	06A530-A2P11-11	22	WH		LO	1	008	10	06HY033HLA035				TSB		15.3.2004
	NULL	06A808-TB SIGNAL-24	06A530-A2P11-12	22	WH		LO	1	008	11	06HY033HLA036				TSB		15.3.2004
	NULL	06A808-TB SIGNAL-26	06A530-A2P11-13	22	WH		LO	1	008	12	06HY033HLA037				TSB		15.3.2004
	NULL	06A808-TB SIGNAL-28	06A530-A2P11-14	22	WH		LO	1	008	13	06HY033HLA038				TSB		15.3.2004
	NULL	06A808-TB SIGNAL-30	06A530-A2P11-15	22	WH		LO	1	008	14	06HY033HLA039				TSB		15.3.2004
	NULL	06A808-TB SIGNAL-32	06A530-A2P11-16	22	WH		LO	1	008	15	06HY033HLA040				TSB		15.3.2004
	NULL	06A809-TB SIGNAL-02	06A530-A2P12-01	22	WH		LO	1	009	00	06HY033HLA041				TSB		15.3.2004
6	NULL	06A813-TB SIGNAL-22	06P05-11	22	WH	1A	LO	1	116	10	06HY033HLA042				TSB	D	15.3.2004
6	NULL	06A813-TB SIGNAL-24	06P05-12	22	WH	1A	LO	1	116	11	06HY033HLA043				TSB	D	15.3.2004
6	NULL	06A809-TB SIGNAL-16	06A530-A2P12-08	22	WH		LO	1	009	07	06HY033HLA044				TSB	D	15.3.2004
6	NULL	06A809-TB SIGNAL-18	06A530-A2P12-09	22	WH		LO	1	009	08	06HY033HLA045				TSB	D	15.3.2004
6	NULL	06A809-TB SIGNAL-20	06A530-A2P12-10	22	WH		LO	1	009	09	06HY033HLA046				TSB	D	15.3.2004
6	NULL	06A809-TB SIGNAL-22	06A530-A2P12-11	22	WH		LO	1	009	10	06HY033HLA047				TSB	D	15.3.2004
6	NULL	06A809-TB SIGNAL-24	06A530-A2P12-12	22	WH		LO	1	009	11	06HY033HLA048				TSB	D	15.3.2004
6	NULL	06A809-TB SIGNAL-26	06A530-A2P12-13	22	WH		LO	1	009	12	06HY033HLA049				TSB	D	15.3.2004
6	NULL	06A809-TB SIGNAL-28	06A530-A2P12-14	22	WH		LO	1	009	13	06HY033HLA050				TSB	D	15.3.2004
6	NULL	06A809-TB SIGNAL-30	06A530-A2P12-15	22	WH		LO	1	009	14	06HY033HLA051				TSB	D	15.3.2004
6	NULL	06A809-TB SIGNAL-32	06A530-A2P12-16	22	WH		LO	1	009	15	06HY033HLA052				TSB	D	15.3.2004
6	NULL	06A812-TB SIGNAL-2	06P04-01	22	WH	1A	LO	1	115	00	06HY033HLA053				TSB	D	15.3.2004
6	NULL	06A812-TB SIGNAL-4	06P04-02	22	WH	1A	LO	1	115	01	06HY033HLA054				TSB	D	15.3.2004
6	NULL	06A812-TB SIGNAL-6	06P04-03	22	WH	1A	LO	1	115	02	06HY033HLA055				TSB	D	15.3.2004
6	NULL	06A812-TB SIGNAL-8	06P04-04	22	WH	1A	LO	1	115	03	06HY033HLA056				TSB	D	15.3.2004
6	NULL	06A812-TB SIGNAL-10	06P04-05	22	WH	1A	LO	1	115	04	06HY033HLA057				TSB	D	15.3.2004
6	NULL	06A812-TB SIGNAL-12	06P04-06	22	WH	1A	LO	1	115	05	06HY033HLA058				TSB	D	15.3.2004
6	NULL	06A812-TB SIGNAL-14	06P04-07	22	WH	1A	LO	1	115	06	06HY033HLA059				TSB	D	15.3.2004
6	NULL	06A812-TB SIGNAL-16	06P04-08	22	WH	1A	LO	1	115	07	06HY033HLA060				TSB	D	15.3.2004
6	NULL	06A812-TB SIGNAL-18	06P04-09	22	WH	1A	LO	1	115	08	06HY033HLA061				TSB	D	15.3.2004
6	NULL	06A812-TB SIGNAL-20	06P04-10	22	WH	1A	LO	1	115	09	06HY033HLA062				TSB	D	15.3.2004
6	NULL	06A812-TB SIGNAL-22	06P04-11	22	WH	1A	LO	1	115	10	06HY033HLA063				TSB	D	15.3.2004

coord	coord_	From	To	WC	CC	NC	IO	SC	Word	bit	remarks	power	origin	daisy_	ped	rev_le	write_date
6	NULL	06A812-TB SIGNAL-24	06P04-12	22	WH	1A	LO	1	115	11	06HY033HLA064				TSB	D	15.3.2004
6	NULL	06A812-TB SIGNAL-26	06P04-13	22	WH	1A	LO	1	115	12	06HY033HLA065				TSB	D	15.3.2004
6	NULL	06A812-TB SIGNAL-28	06P04-14	22	WH	1A	LO	1	115	13	06HY033HLA066				TSB	D	15.3.2004
6	NULL	06A812-TB SIGNAL-30	06P04-15	22	WH	1A	LO	1	115	14	06HY033HLA067				TSB	D	15.3.2004
6	NULL	06A812-TB SIGNAL-32	06P04-16	22	WH	1A	LO	1	115	15	06HY033HLA068				TSB	D	15.3.2004
6	NULL	06A813-TB SIGNAL-2	06P05-01	22	WH	1A	LO	1	116	00	06HY033HLA069				TSB	D	15.3.2004
6	NULL	06A813-TB SIGNAL-4	06P05-02	22	WH	1A	LO	1	116	01	06HY033HLA070				TSB	D	15.3.2004
6	NULL	06A813-TB SIGNAL-6	06P05-03	22	WH	1A	LO	1	116	02	06HY033HLA071				TSB	D	15.3.2004
6	NULL	06A813-TB SIGNAL-8	06P05-04	22	WH	1A	LO	1	116	03	06HY033HLA072				TSB	D	15.3.2004
6	NULL	06A813-TB SIGNAL-10	06P05-05	22	WH	1A	LO	1	116	04	06HY033HLA073				TSB	D	15.3.2004
6	NULL	06A813-TB SIGNAL-12	06P05-06	22	WH	1A	LO	1	116	05	06HY033HLA074				TSB	D	15.3.2004
6	NULL	06A813-TB SIGNAL-14	06P05-07	22	WH	1A	LO	1	116	06	06HY033HLA075				TSB	D	15.3.2004
6	NULL	06A813-TB SIGNAL-16	06P05-08	22	WH	1A	LO	1	116	07	06HY033HLA076				TSB	D	15.3.2004
6	NULL	06A813-TB SIGNAL-18	06P05-09	22	WH	1A	LO	1	116	08	06HY033HLA077				TSB	D	15.3.2004
6	NULL	06A813-TB SIGNAL-20	06P05-10	22	WH	1A	LO	1	116	09	06HY033HLA078				TSB	D	15.3.2004
6	NULL	06P04	05A533-A2J12				1J				CONN 102387-7					D	15.3.2004
6	NULL	06P05	05A533-A2J13				1J				CONN 102387-7					D	15.3.2004
UNIT 4																	
4	NULL	04A800-E1	04W1A	14	WH							FRM GND					15.3.2004
4	NULL	04A800-TB POWER-01	04A800-TB POWER-03	16	BK	1N						220 VAC	04A550CB03				15.3.2004
4	NULL	04A800-TB POWER-03	04A800-TB POWER-05	16	BK	1N						220 VAC	04A550CB03				15.3.2004
4	NULL	04A800-TB POWER-05	04A800-TB POWER-07	16	BK	1N						220 VAC	04A550CB03				15.3.2004
4	NULL	04A800-TB POWER-07	04A800-TB POWER-09	16	BK	1N						220 VAC	04A550CB03				15.3.2004
4	NULL	04A800-TB POWER-09	04A800-TB POWER-11	16	BK	1N						220 VAC	04A550CB03				15.3.2004
4	NULL	04A800-TB POWER-11	04A800-TB POWER-13	16	BK	1N						220 VAC	04A550CB03				15.3.2004
4	NULL	04A800-TB POWER-13	04A800-TB POWER-15	16	BK	1N						220 VAC	04A550CB03				15.3.2004
4	NULL	04A800-TB POWER-15	04A800-TB POWER-17	16	BK	1N						220 VAC	04A550CB03				15.3.2004
4	NULL	04A800-TB POWER-17	04A800-TB POWER-19	16	BK	1N						220 VAC	04A550CB03				15.3.2004
4	NULL	04A800-TB POWER-19	04A800-TB POWER-21	16	BK	1N						220 VAC	04A550CB03				15.3.2004
4	NULL	04A800-TB POWER-21	04A800-TB POWER-23	16	BK	1N						220 VAC	04A550CB03				15.3.2004
4	NULL	04A800-TB POWER-23	04A800-TB POWER-25	16	BK	1N						220 VAC	04A550CB03				15.3.2004
4	NULL	04A800-TB POWER-25	04A800-TB POWER-27	16	BK	1N						220 VAC	04A550CB03				15.3.2004
4	NULL	04A800-TB POWER-27	04A800-TB POWER-29	16	BK	1N						220 VAC	04A550CB03				15.3.2004
4	NULL	04A800-TB POWER-29	04A800-TB POWER-31	16	BK	1N						220 VAC	04A550CB03				15.3.2004
4	NULL	04A800-TB POWER-31	04A801-TB POWER-01	16	BK	1N						220 VAC	04A550CB03				15.3.2004
4	NULL	04A800-TB-(+)	04A801-TB-(+)	16	WH						SOURCE 04PS01	+24 VDC	04A565CB01				15.3.2004
4	NULL	04A800-TB-(+)	04TB201-11	16	WH						SOURCE 04PS01	+24 VDC	04A565CB01				15.3.2004
4	NULL	04A801-E1	04W1A	14	WH							FRM GND					15.3.2004
4	NULL	04A801-TB POWER-01	04A801-TB POWER-03	16	BK	1N						220 VAC	04A550CB03				15.3.2004
4	NULL	04A801-TB POWER-03	04A801-TB POWER-05	16	BK	1N						220 VAC	04A550CB03				15.3.2004
4	NULL	04A801-TB POWER-05	04A801-TB POWER-07	16	BK	1N						220 VAC	04A550CB03				15.3.2004
4	NULL	04A801-TB POWER-07	04A801-TB POWER-09	16	BK	1N						220 VAC	04A550CB03				15.3.2004
4	NULL	04A801-TB POWER-09	04A801-TB POWER-11	16	BK	1N						220 VAC	04A550CB03				15.3.2004
4	NULL	04A801-TB POWER-11	04A801-TB POWER-13	16	BK	1N						220 VAC	04A550CB03				15.3.2004
4	NULL	04A801-TB POWER-13	04A801-TB POWER-15	16	BK	1N						220 VAC	04A550CB03				15.3.2004
4	NULL	04A801-TB POWER-15	04A801-TB POWER-17	16	BK	1N						220 VAC	04A550CB03				15.3.2004
4	NULL	04A801-TB POWER-17	04A801-TB POWER-19	16	BK	1N						220 VAC	04A550CB03				15.3.2004
4	NULL	04A801-TB POWER-19	04A801-TB POWER-21	16	BK	1N						220 VAC	04A550CB03				15.3.2004
4	NULL	04A801-TB POWER-21	04A801-TB POWER-23	16	BK	1N						220 VAC	04A550CB03				15.3.2004
4	NULL	04A801-TB POWER-23	04A801-TB POWER-25	16	BK	1N						220 VAC	04A550CB03				15.3.2004
4	NULL	04A801-TB POWER-25	04A801-TB POWER-27	16	BK	1N						220 VAC	04A550CB03				15.3.2004
4	NULL	04A801-TB POWER-27	04A801-TB POWER-29	16	BK	1N						220 VAC	04A550CB03				15.3.2004
4	NULL	04A801-TB POWER-29	04A801-TB POWER-31	16	BK	1N						220 VAC	04A550CB03				15.3.2004
4	NULL	04A801-TB POWER-31	04A802-TB POWER-01	16	BK	1N						220 VAC	04A550CB03				15.3.2004

coord	coord_	From	To	WC	CC	NC	IO	SC	Word	bit	remarks	power	origin	daisy_	ped	rev_le	write_date
4	NULL	04A801-TB-(+)	04A802-TB-(+)	16	WH						SOURCE 04PS01	+24 VDC	04A565CB01				15.3.2004
4	NULL	04A802-E1	04W1A	14	WH							FRM GND					15.3.2004
4	NULL	04A802-TB POWER-01	04A802-TB POWER-03	16	BK	1N						220 VAC	04A550CB03				15.3.2004
4	NULL	04A802-TB POWER-03	04A802-TB POWER-05	16	BK	1N						220 VAC	04A550CB03				15.3.2004
4	NULL	04A802-TB POWER-05	04A802-TB POWER-07	16	BK	1N						220 VAC	04A550CB03				15.3.2004
4	NULL	04A802-TB POWER-07	04A802-TB POWER-09	16	BK	1N						220 VAC	04A550CB03				15.3.2004
4	NULL	04A802-TB POWER-09	04A802-TB POWER-11	16	BK	1N						220 VAC	04A550CB03				15.3.2004
4	NULL	04A802-TB POWER-11	04A802-TB POWER-13	16	BK	1N						220 VAC	04A550CB03				15.3.2004
4	NULL	04A802-TB POWER-13	04A802-TB POWER-15	16	BK	1N						220 VAC	04A550CB03				15.3.2004
4	NULL	04A802-TB POWER-15	04A802-TB POWER-17	16	BK	1N						220 VAC	04A550CB03				15.3.2004
4	NULL	04A802-TB POWER-17	04A802-TB POWER-19	16	BK	1N						220 VAC	04A550CB03				15.3.2004
4	NULL	04A802-TB POWER-19	04A802-TB POWER-21	16	BK	1N						220 VAC	04A550CB03				15.3.2004
4	NULL	04A802-TB POWER-21	04A802-TB POWER-23	16	BK	1N						220 VAC	04A550CB03				15.3.2004
4	NULL	04A802-TB POWER-23	04A802-TB POWER-25	16	BK	1N						220 VAC	04A550CB03				15.3.2004
4	NULL	04A802-TB POWER-25	04A802-TB POWER-27	16	BK	1N						220 VAC	04A550CB03				15.3.2004
4	NULL	04A802-TB POWER-27	04A802-TB POWER-29	16	BK	1N						220 VAC	04A550CB03				15.3.2004
4	NULL	04A802-TB POWER-29	04A802-TB POWER-31	16	BK	1N						220 VAC	04A550CB03				15.3.2004
4	NULL	04A802-TB POWER-31	04A803-TB POWER-01	16	BK	1N						220 VAC	04A550CB03				15.3.2004
4	NULL	04A802-TB-(+)	04A803-TB-(+)	16	WH						SOURCE 04PS01	+24 VDC	04A565CB01				15.3.2004
4	NULL	04A803-E1	04W1A	14	WH							FRM GND					15.3.2004
4	NULL	04A803-TB POWER-01	04A803-TB POWER-03	16	BK	1N						220 VAC	04A550CB03				15.3.2004
4	NULL	04A803-TB POWER-03	04A803-TB POWER-05	16	BK	1N						220 VAC	04A550CB03				15.3.2004
4	NULL	04A803-TB POWER-05	04A803-TB POWER-07	16	BK	1N						220 VAC	04A550CB03				15.3.2004
4	NULL	04A803-TB POWER-07	04A803-TB POWER-09	16	BK	1N						220 VAC	04A550CB03				15.3.2004
4	NULL	04A803-TB POWER-09	04A803-TB POWER-11	16	BK	1N						220 VAC	04A550CB03				15.3.2004
4	NULL	04A803-TB POWER-11	04A803-TB POWER-13	16	BK	1N						220 VAC	04A550CB03				15.3.2004
4	NULL	04A803-TB POWER-13	04A803-TB POWER-15	16	BK	1N						220 VAC	04A550CB03				15.3.2004
4	NULL	04A803-TB POWER-15	04A803-TB POWER-17	16	BK	1N						220 VAC	04A550CB03				15.3.2004
4	NULL	04A803-TB POWER-17	04A803-TB POWER-19	16	BK	1N						220 VAC	04A550CB03				15.3.2004
4	NULL	04A803-TB POWER-19	04A803-TB POWER-21	16	BK	1N						220 VAC	04A550CB03				15.3.2004
4	NULL	04A803-TB POWER-21	04A803-TB POWER-23	16	BK	1N						220 VAC	04A550CB03				15.3.2004
4	NULL	04A803-TB POWER-23	04A803-TB POWER-25	16	BK	1N						220 VAC	04A550CB03				15.3.2004
4	NULL	04A803-TB POWER-25	04A803-TB POWER-27	16	BK	1N						220 VAC	04A550CB03				15.3.2004
4	NULL	04A803-TB POWER-27	04A803-TB POWER-29	16	BK	1N						220 VAC	04A550CB03				15.3.2004
4	NULL	04A803-TB POWER-29	04A803-TB POWER-31	16	BK	1N						220 VAC	04A550CB03				15.3.2004
4	NULL	04A803-TB POWER-31	04A804-TB POWER-01	16	BK	1N						220 VAC	04A550CB03				15.3.2004
4	NULL	04A803-TB-(+)	04A804-TB-(+)	16	WH						SOURCE 04PS01	+24 VDC	04A565CB01				15.3.2004
4	NULL	04A804-E1	04W1A	14	WH							FRM GND					15.3.2004
4	NULL	04A804-TB POWER-01	04A804-TB POWER-03	16	BK	1N						220 VAC	04A550CB03				15.3.2004
4	NULL	04A804-TB POWER-03	04A804-TB POWER-05	16	BK	1N						220 VAC	04A550CB03				15.3.2004
4	NULL	04A804-TB POWER-05	04A804-TB POWER-07	16	BK	1N						220 VAC	04A550CB03				15.3.2004
4	NULL	04A804-TB POWER-07	04A804-TB POWER-09	16	BK	1N						220 VAC	04A550CB03				15.3.2004
4	NULL	04A804-TB POWER-09	04A804-TB POWER-11	16	BK	1N						220 VAC	04A550CB03				15.3.2004
4	NULL	04A804-TB POWER-11	04A804-TB POWER-13	16	BK	1N						220 VAC	04A550CB03				15.3.2004
4	NULL	04A804-TB POWER-13	04A804-TB POWER-15	16	BK	1N						220 VAC	04A550CB03				15.3.2004
4	NULL	04A804-TB POWER-15	04A804-TB POWER-17	16	BK	1N						220 VAC	04A550CB03				15.3.2004
4	NULL	04A804-TB POWER-17	04A804-TB POWER-19	16	BK	1N						220 VAC	04A550CB03				15.3.2004
4	NULL	04A804-TB POWER-19	04A804-TB POWER-21	16	BK	1N						220 VAC	04A550CB03				15.3.2004
4	NULL	04A804-TB POWER-21	04A804-TB POWER-23	16	BK	1N						220 VAC	04A550CB03				15.3.2004
4	NULL	04A804-TB POWER-23	04A804-TB POWER-25	16	BK	1N						220 VAC	04A550CB03				15.3.2004
4	NULL	04A804-TB POWER-25	04A804-TB POWER-27	16	BK	1N						220 VAC	04A550CB03				15.3.2004
4	NULL	04A804-TB POWER-27	04A804-TB POWER-29	16	BK	1N						220 VAC	04A550CB03				15.3.2004
4	NULL	04A804-TB POWER-29	04A804-TB POWER-31	16	BK	1N						220 VAC	04A550CB03				15.3.2004
4	NULL	04A804-TB-(+)	04A805-TB-(+)	16	WH						SOURCE 04PS01	+24 VDC	04A565CB01				15.3.2004

coord	coord_	From	To	WC	CC	NC	IO	SC	Word	bit	remarks	power	origin	daisy_	ped	rev_le	write_date
4	NULL	04A805-E1	04W1A	14	WH							FRM GND					15.3.2004
4	NULL	04A805-TB POWER-01	04A805-TB POWER-03	16	BK	1N						220 VAC	04A550CB04				15.3.2004
4	NULL	04A805-TB POWER-03	04A805-TB POWER-05	16	BK	1N						220 VAC	04A550CB04				15.3.2004
4	NULL	04A805-TB POWER-05	04A805-TB POWER-07	16	BK	1N						220 VAC	04A550CB04				15.3.2004
4	NULL	04A805-TB POWER-07	04A805-TB POWER-09	16	BK	1N						220 VAC	04A550CB04				15.3.2004
4	NULL	04A805-TB POWER-09	04A805-TB POWER-11	16	BK	1N						220 VAC	04A550CB04				15.3.2004
4	NULL	04A805-TB POWER-11	04A805-TB POWER-13	16	BK	1N						220 VAC	04A550CB04				15.3.2004
4	NULL	04A805-TB POWER-13	04A805-TB POWER-15	16	BK	1N						220 VAC	04A550CB04				15.3.2004
4	NULL	04A805-TB POWER-15	04A805-TB POWER-17	16	BK	1N						220 VAC	04A550CB04				15.3.2004
4	NULL	04A805-TB POWER-17	04A805-TB POWER-19	16	BK	1N						220 VAC	04A550CB04				15.3.2004
4	NULL	04A805-TB POWER-19	04A805-TB POWER-21	16	BK	1N						220 VAC	04A550CB04				15.3.2004
4	NULL	04A805-TB POWER-21	04A805-TB POWER-23	16	BK	1N						220 VAC	04A550CB04				15.3.2004
4	NULL	04A805-TB POWER-23	04A805-TB POWER-25	16	BK	1N						220 VAC	04A550CB04				15.3.2004
4	NULL	04A805-TB POWER-25	04A805-TB POWER-27	16	BK	1N						220 VAC	04A550CB04				15.3.2004
4	NULL	04A805-TB POWER-27	04A805-TB POWER-29	16	BK	1N						220 VAC	04A550CB04				15.3.2004
4	NULL	04A805-TB POWER-29	04A805-TB POWER-31	16	BK	1N						220 VAC	04A550CB04				15.3.2004
4	NULL	04A805-TB POWER-31	04A806-TB POWER-01	16	BK	1N						220 VAC	04A550CB04				15.3.2004
4	NULL	04A805-TB-(+)	04A806-TB-(+)	16	WH						SOURCE 04PS01	+24 VDC	04A565CB01				15.3.2004
4	NULL	04A806-E1	04W1A	14	WH							FRM GND					15.3.2004
4	NULL	04A806-TB POWER-01	04A806-TB POWER-03	16	BK	1N						220 VAC	04A550CB04				15.3.2004
4	NULL	04A806-TB POWER-03	04A806-TB POWER-05	16	BK	1N						220 VAC	04A550CB04				15.3.2004
4	NULL	04A806-TB POWER-05	04A806-TB POWER-07	16	BK	1N						220 VAC	04A550CB04				15.3.2004
4	NULL	04A806-TB POWER-07	04A806-TB POWER-09	16	BK	1N						220 VAC	04A550CB04				15.3.2004
4	NULL	04A806-TB POWER-09	04A806-TB POWER-11	16	BK	1N						220 VAC	04A550CB04				15.3.2004
4	NULL	04A806-TB POWER-11	04A806-TB POWER-13	16	BK	1N						220 VAC	04A550CB04				15.3.2004
4	NULL	04A806-TB POWER-13	04A806-TB POWER-15	16	BK	1N						220 VAC	04A550CB04				15.3.2004
4	NULL	04A806-TB POWER-15	04A806-TB POWER-17	16	BK	1N						220 VAC	04A550CB04				15.3.2004
4	NULL	04A806-TB POWER-17	04A806-TB POWER-19	16	BK	1N						220 VAC	04A550CB04				15.3.2004
4	NULL	04A806-TB POWER-19	04A806-TB POWER-21	16	BK	1N						220 VAC	04A550CB04				15.3.2004
4	NULL	04A806-TB POWER-21	04A806-TB POWER-23	16	BK	1N						220 VAC	04A550CB04				15.3.2004
4	NULL	04A806-TB POWER-23	04A806-TB POWER-25	16	BK	1N						220 VAC	04A550CB04				15.3.2004
4	NULL	04A806-TB POWER-25	04A806-TB POWER-27	16	BK	1N						220 VAC	04A550CB04				15.3.2004
4	NULL	04A806-TB POWER-27	04A806-TB POWER-29	16	BK	1N						220 VAC	04A550CB04				15.3.2004
4	NULL	04A806-TB POWER-29	04A806-TB POWER-31	16	BK	1N						220 VAC	04A550CB04				15.3.2004
4	NULL	04A806-TB POWER-31	04A807-TB POWER-01	16	BK	1N						220 VAC	04A550CB04				15.3.2004
4	NULL	04A806-TB-(+)	04A807-TB-(+)	16	WH						SOURCE 04PS01	+24 VDC	04A565CB01				15.3.2004
4	NULL	04A807-E1	04W1A	14	WH							FRM GND					15.3.2004
4	NULL	04A807-TB POWER-01	04A807-TB POWER-03	16	BK	1N						220 VAC	04A550CB04				15.3.2004
4	NULL	04A807-TB POWER-03	04A807-TB POWER-05	16	BK	1N						220 VAC	04A550CB04				15.3.2004
4	NULL	04A807-TB POWER-05	04A807-TB POWER-07	16	BK	1N						220 VAC	04A550CB04				15.3.2004
4	NULL	04A807-TB POWER-07	04A807-TB POWER-09	16	BK	1N						220 VAC	04A550CB04				15.3.2004
4	NULL	04A807-TB POWER-09	04A807-TB POWER-11	16	BK	1N						220 VAC	04A550CB04				15.3.2004
4	NULL	04A807-TB POWER-11	04A807-TB POWER-13	16	BK	1N						220 VAC	04A550CB04				15.3.2004
4	NULL	04A807-TB POWER-13	04A807-TB POWER-15	16	BK	1N						220 VAC	04A550CB04				15.3.2004
4	NULL	04A807-TB POWER-15	04A807-TB POWER-17	16	BK	1N						220 VAC	04A550CB04				15.3.2004
4	NULL	04A807-TB POWER-17	04A807-TB POWER-19	16	BK	1N						220 VAC	04A550CB04				15.3.2004
4	NULL	04A807-TB POWER-19	04A807-TB POWER-21	16	BK	1N						220 VAC	04A550CB04				15.3.2004
4	NULL	04A807-TB POWER-21	04A807-TB POWER-23	16	BK	1N						220 VAC	04A550CB04				15.3.2004
4	NULL	04A807-TB POWER-23	04A807-TB POWER-25	16	BK	1N						220 VAC	04A550CB04				15.3.2004
4	NULL	04A807-TB POWER-25	04A807-TB POWER-27	16	BK	1N						220 VAC	04A550CB04				15.3.2004
4	NULL	04A807-TB POWER-27	04A807-TB POWER-29	16	BK	1N						220 VAC	04A550CB04				15.3.2004
4	NULL	04A807-TB POWER-29	04A807-TB POWER-31	16	BK	1N						220 VAC	04A550CB04				15.3.2004
4	NULL	04A807-TB POWER-31	04A808-TB POWER-01	16	BK	1N						220 VAC	04A550CB04				15.3.2004
4	NULL	04A807-TB-(+)	04A808-TB-(+)	16	WH						SOURCE 04PS01	+24 VDC	04A565CB01				15.3.2004

coord	coord_	From	To	WC	CC	NC	IO	SC	Word	bit	remarks	power	origin	daisy_	ped	rev_le	write_date
4	NULL	04A808-E1	04W1A	14	WH							FRM GND					15.3.2004
4	NULL	04A808-TB POWER-01	04A808-TB POWER-03	16	BK	1N						220 VAC	04A550CB04				15.3.2004
4	NULL	04A808-TB POWER-03	04A808-TB POWER-05	16	BK	1N						220 VAC	04A550CB04				15.3.2004
4	NULL	04A808-TB POWER-05	04A808-TB POWER-07	16	BK	1N						220 VAC	04A550CB04				15.3.2004
4	NULL	04A808-TB POWER-07	04A808-TB POWER-09	16	BK	1N						220 VAC	04A550CB04				15.3.2004
4	NULL	04A808-TB POWER-09	04A808-TB POWER-11	16	BK	1N						220 VAC	04A550CB04				15.3.2004
4	NULL	04A808-TB POWER-11	04A808-TB POWER-13	16	BK	1N						220 VAC	04A550CB04				15.3.2004
4	NULL	04A808-TB POWER-13	04A808-TB POWER-15	16	BK	1N						220 VAC	04A550CB04				15.3.2004
4	NULL	04A808-TB POWER-15	04A808-TB POWER-17	16	BK	1N						220 VAC	04A550CB04				15.3.2004
4	NULL	04A808-TB POWER-17	04A808-TB POWER-19	16	BK	1N						220 VAC	04A550CB04				15.3.2004
4	NULL	04A808-TB POWER-19	04A808-TB POWER-21	16	BK	1N						220 VAC	04A550CB04				15.3.2004
4	NULL	04A808-TB POWER-21	04A808-TB POWER-23	16	BK	1N						220 VAC	04A550CB04				15.3.2004
4	NULL	04A808-TB POWER-23	04A808-TB POWER-25	16	BK	1N						220 VAC	04A550CB04				15.3.2004
4	NULL	04A808-TB POWER-25	04A808-TB POWER-27	16	BK	1N						220 VAC	04A550CB04				15.3.2004
4	NULL	04A808-TB POWER-27	04A808-TB POWER-29	16	BK	1N						220 VAC	04A550CB04				15.3.2004
4	NULL	04A808-TB POWER-29	04A808-TB POWER-31	16	BK	1N						220 VAC	04A550CB04				15.3.2004
4	NULL	04A808-TB POWER-31	04A809-TB POWER-01	16	BK	1N						220 VAC	04A550CB04				15.3.2004
4	NULL	04A808-TB-(+)	04A809-TB-(+)	16	WH						SOURCE 04PS01	+24 VDC	04A565CB01				15.3.2004
4	NULL	04A809-E1	04W1A	14	WH							FRM GND					15.3.2004
4	NULL	04A809-TB POWER-01	04A809-TB POWER-03	16	BK	1N						220 VAC	04A550CB04				15.3.2004
4	NULL	04A809-TB POWER-03	04A809-TB POWER-05	16	BK	1N						220 VAC	04A550CB04				15.3.2004
4	NULL	04A809-TB POWER-05	04A809-TB POWER-07	16	BK	1N						220 VAC	04A550CB04				15.3.2004
4	NULL	04A809-TB POWER-07	04A809-TB POWER-09	16	BK	1N						220 VAC	04A550CB04				15.3.2004
4	NULL	04A809-TB POWER-09	04A809-TB POWER-11	16	BK	1N						220 VAC	04A550CB04				15.3.2004
4	NULL	04A809-TB POWER-11	04A809-TB POWER-13	16	BK	1N						220 VAC	04A550CB04				15.3.2004
4	NULL	04A809-TB POWER-13	04A809-TB POWER-15	16	BK	1N						220 VAC	04A550CB04				15.3.2004
4	NULL	04A809-TB POWER-15	04A809-TB POWER-17	16	BK	1N						220 VAC	04A550CB04				15.3.2004
4	NULL	04A809-TB POWER-17	04A809-TB POWER-19	16	BK	1N						220 VAC	04A550CB04				15.3.2004
4	NULL	04A809-TB POWER-19	04A809-TB POWER-21	16	BK	1N						220 VAC	04A550CB04				15.3.2004
4	NULL	04A809-TB POWER-21	04A809-TB POWER-23	16	BK	1N						220 VAC	04A550CB04				15.3.2004
4	NULL	04A809-TB POWER-23	04A809-TB POWER-25	16	BK	1N						220 VAC	04A550CB04				15.3.2004
4	NULL	04A809-TB POWER-25	04A809-TB POWER-27	16	BK	1N						220 VAC	04A550CB04				15.3.2004
4	NULL	04A809-TB POWER-27	04A809-TB POWER-29	16	BK	1N						220 VAC	04A550CB04				15.3.2004
4	NULL	04A809-TB POWER-29	04A809-TB POWER-31	16	BK	1N						220 VAC	04A550CB04				15.3.2004
UNIT 5																	
5	NULL	05A800-E1	05W1A	14	WH							FRM GND					15.3.2004
5	NULL	05A800-TB POWER-01	05A800-TB POWER-03	16	BK	1N						220 VAC	05A550CB03				15.3.2004
5	NULL	05A800-TB POWER-03	05A800-TB POWER-05	16	BK	1N						220 VAC	05A550CB03				15.3.2004
5	NULL	05A800-TB POWER-05	05A800-TB POWER-07	16	BK	1N						220 VAC	05A550CB03				15.3.2004
5	NULL	05A800-TB POWER-07	05A800-TB POWER-09	16	BK	1N						220 VAC	05A550CB03				15.3.2004
5	NULL	05A800-TB POWER-09	05A800-TB POWER-11	16	BK	1N						220 VAC	05A550CB03				15.3.2004
5	NULL	05A800-TB POWER-11	05A800-TB POWER-13	16	BK	1N						220 VAC	05A550CB03				15.3.2004
5	NULL	05A800-TB POWER-13	05A800-TB POWER-15	16	BK	1N						220 VAC	05A550CB03				15.3.2004
5	NULL	05A800-TB POWER-15	05A800-TB POWER-17	16	BK	1N						220 VAC	05A550CB03				15.3.2004
5	NULL	05A800-TB POWER-17	05A800-TB POWER-19	16	BK	1N						220 VAC	05A550CB03				15.3.2004
5	NULL	05A800-TB POWER-19	05A800-TB POWER-21	16	BK	1N						220 VAC	05A550CB03				15.3.2004
5	NULL	05A800-TB POWER-21	05A800-TB POWER-23	16	BK	1N						220 VAC	05A550CB03				15.3.2004
5	NULL	05A800-TB POWER-23	05A800-TB POWER-25	16	BK	1N						220 VAC	05A550CB03				15.3.2004
5	NULL	05A800-TB POWER-25	05A800-TB POWER-27	16	BK	1N						220 VAC	05A550CB03				15.3.2004
5	NULL	05A800-TB POWER-27	05A800-TB POWER-29	16	BK	1N						220 VAC	05A550CB03				15.3.2004
5	NULL	05A800-TB POWER-29	05A800-TB POWER-31	16	BK	1N						220 VAC	05A550CB03				15.3.2004
5	NULL	05A800-TB POWER-31	05A801-TB POWER-01	16	BK	1N						220 VAC	05A550CB03				15.3.2004
5	NULL	05A800-TB-(+)	05A801-TB-(+)	16	WH						SOURCE 05PS01	+24 VDC	05A565CB01				15.3.2004
5	NULL	05A800-TB-(+)	05TB201-12	16	WH						SOURCE 05PS01	+24 VDC	05A565CB01				15.3.2004

coord	coord_	From	To	WC	CC	NC	IO	SC	Word	bit	remarks	power	origin	daisy_	ped	rev_le	write_date
5	NULL	05A801-E1	05W1A	14	WH							FRM GND					15.3.2004
5	NULL	05A801-TB POWER-01	05A801-TB POWER-03	16	BK	1N						220 VAC	05A550CB03				15.3.2004
5	NULL	05A801-TB POWER-03	05A801-TB POWER-05	16	BK	1N						220 VAC	05A550CB03				15.3.2004
5	NULL	05A801-TB POWER-05	05A801-TB POWER-07	16	BK	1N						220 VAC	05A550CB03				15.3.2004
5	NULL	05A801-TB POWER-07	05A801-TB POWER-09	16	BK	1N						220 VAC	05A550CB03				15.3.2004
5	NULL	05A801-TB POWER-09	05A801-TB POWER-11	16	BK	1N						220 VAC	05A550CB03				15.3.2004
5	NULL	05A801-TB POWER-11	05A801-TB POWER-13	16	BK	1N						220 VAC	05A550CB03				15.3.2004
5	NULL	05A801-TB POWER-13	05A801-TB POWER-15	16	BK	1N						220 VAC	05A550CB03				15.3.2004
5	NULL	05A801-TB POWER-15	05A801-TB POWER-17	16	BK	1N						220 VAC	05A550CB03				15.3.2004
5	NULL	05A801-TB POWER-17	05A801-TB POWER-19	16	BK	1N						220 VAC	05A550CB03				15.3.2004
5	NULL	05A801-TB POWER-19	05A801-TB POWER-21	16	BK	1N						220 VAC	05A550CB03				15.3.2004
5	NULL	05A801-TB POWER-21	05A801-TB POWER-23	16	BK	1N						220 VAC	05A550CB03				15.3.2004
5	NULL	05A801-TB POWER-23	05A801-TB POWER-25	16	BK	1N						220 VAC	05A550CB03				15.3.2004
5	NULL	05A801-TB POWER-25	05A801-TB POWER-27	16	BK	1N						220 VAC	05A550CB03				15.3.2004
5	NULL	05A801-TB POWER-27	05A801-TB POWER-29	16	BK	1N						220 VAC	05A550CB03				15.3.2004
5	NULL	05A801-TB POWER-29	05A801-TB POWER-31	16	BK	1N						220 VAC	05A550CB03				15.3.2004
5	NULL	05A801-TB POWER-31	05A802-TB POWER-01	16	BK	1N						220 VAC	05A550CB03				15.3.2004
5	NULL	05A801-TB-(+)	05A802-TB-(+)	16	WH						SOURCE 05PS01	+24 VDC	05A565CB01				15.3.2004
5	NULL	05A802-E1	05W1A	14	WH							FRM GND					15.3.2004
5	NULL	05A802-TB POWER-01	05A802-TB POWER-03	16	BK	1N						220 VAC	05A550CB03				15.3.2004
5	NULL	05A802-TB POWER-03	05A802-TB POWER-05	16	BK	1N						220 VAC	05A550CB03				15.3.2004
5	NULL	05A802-TB POWER-05	05A802-TB POWER-07	16	BK	1N						220 VAC	05A550CB03				15.3.2004
5	NULL	05A802-TB POWER-07	05A802-TB POWER-09	16	BK	1N						220 VAC	05A550CB03				15.3.2004
5	NULL	05A802-TB POWER-09	05A802-TB POWER-11	16	BK	1N						220 VAC	05A550CB03				15.3.2004
5	NULL	05A802-TB POWER-11	05A802-TB POWER-13	16	BK	1N						220 VAC	05A550CB03				15.3.2004
5	NULL	05A802-TB POWER-13	05A802-TB POWER-15	16	BK	1N						220 VAC	05A550CB03				15.3.2004
5	NULL	05A802-TB POWER-15	05A802-TB POWER-17	16	BK	1N						220 VAC	05A550CB03				15.3.2004
5	NULL	05A802-TB POWER-17	05A802-TB POWER-19	16	BK	1N						220 VAC	05A550CB03				15.3.2004
5	NULL	05A802-TB POWER-19	05A802-TB POWER-21	16	BK	1N						220 VAC	05A550CB03				15.3.2004
5	NULL	05A802-TB POWER-21	05A802-TB POWER-23	16	BK	1N						220 VAC	05A550CB03				15.3.2004
5	NULL	05A802-TB POWER-23	05A802-TB POWER-25	16	BK	1N						220 VAC	05A550CB03				15.3.2004
5	NULL	05A802-TB POWER-25	05A802-TB POWER-27	16	BK	1N						220 VAC	05A550CB03				15.3.2004
5	NULL	05A802-TB POWER-27	05A802-TB POWER-29	16	BK	1N						220 VAC	05A550CB03				15.3.2004
5	NULL	05A802-TB POWER-29	05A802-TB POWER-31	16	BK	1N						220 VAC	05A550CB03				15.3.2004
5	NULL	05A802-TB POWER-31	05A803-TB POWER-01	16	BK	1N						220 VAC	05A550CB03				15.3.2004
5	NULL	05A802-TB-(+)	05A803-TB-(+)	16	WH						SOURCE 05PS01	+24 VDC	05A565CB01				15.3.2004
5	NULL	05A803-E1	05W1A	14	WH							FRM GND					15.3.2004
5	NULL	05A803-TB POWER-01	05A803-TB POWER-03	16	BK	1N						220 VAC	05A550CB03				15.3.2004
5	NULL	05A803-TB POWER-03	05A803-TB POWER-05	16	BK	1N						220 VAC	05A550CB03				15.3.2004
5	NULL	05A803-TB POWER-05	05A803-TB POWER-07	16	BK	1N						220 VAC	05A550CB03				15.3.2004
5	NULL	05A803-TB POWER-07	05A803-TB POWER-09	16	BK	1N						220 VAC	05A550CB03				15.3.2004
5	NULL	05A803-TB POWER-09	05A803-TB POWER-11	16	BK	1N						220 VAC	05A550CB03				15.3.2004
5	NULL	05A803-TB POWER-11	05A803-TB POWER-13	16	BK	1N						220 VAC	05A550CB03				15.3.2004
5	NULL	05A803-TB POWER-13	05A803-TB POWER-15	16	BK	1N						220 VAC	05A550CB03				15.3.2004
5	NULL	05A803-TB POWER-15	05A803-TB POWER-17	16	BK	1N						220 VAC	05A550CB03				15.3.2004
5	NULL	05A803-TB POWER-17	05A803-TB POWER-19	16	BK	1N						220 VAC	05A550CB03				15.3.2004
5	NULL	05A803-TB POWER-19	05A803-TB POWER-21	16	BK	1N						220 VAC	05A550CB03				15.3.2004
5	NULL	05A803-TB POWER-21	05A803-TB POWER-23	16	BK	1N						220 VAC	05A550CB03				15.3.2004
5	NULL	05A803-TB POWER-23	05A803-TB POWER-25	16	BK	1N						220 VAC	05A550CB03				15.3.2004
5	NULL	05A803-TB POWER-25	05A803-TB POWER-27	16	BK	1N						220 VAC	05A550CB03				15.3.2004
5	NULL	05A803-TB POWER-27	05A803-TB POWER-29	16	BK	1N						220 VAC	05A550CB03				15.3.2004
5	NULL	05A803-TB POWER-29	05A803-TB POWER-31	16	BK	1N						220 VAC	05A550CB03				15.3.2004
5	NULL	05A803-TB-(+)	05A804-TB-(+)	16	WH						SOURCE 05PS01	+24 VDC	05A565CB01				15.3.2004
5	NULL	05A804-E1	05W1A	14	WH							FRM GND					15.3.2004

coord	coord_	From	To	WC	CC	NC	IO	SC	Word	bit	remarks	power	origin	daisy_	ped	rev_le	write_date
5	NULL	05A804-TB POWER-01	05A804-TB POWER-03	16	BK	1N						220 VAC	05A550CB04				15.3.2004
5	NULL	05A804-TB POWER-03	05A804-TB POWER-05	16	BK	1N						220 VAC	05A550CB04				15.3.2004
5	NULL	05A804-TB POWER-05	05A804-TB POWER-07	16	BK	1N						220 VAC	05A550CB04				15.3.2004
5	NULL	05A804-TB POWER-07	05A804-TB POWER-09	16	BK	1N						220 VAC	05A550CB04				15.3.2004
5	NULL	05A804-TB POWER-09	05A804-TB POWER-11	16	BK	1N						220 VAC	05A550CB04				15.3.2004
5	NULL	05A804-TB POWER-11	05A804-TB POWER-13	16	BK	1N						220 VAC	05A550CB04				15.3.2004
5	NULL	05A804-TB POWER-13	05A804-TB POWER-15	16	BK	1N						220 VAC	05A550CB04				15.3.2004
5	NULL	05A804-TB POWER-15	05A804-TB POWER-17	16	BK	1N						220 VAC	05A550CB04				15.3.2004
5	NULL	05A804-TB POWER-17	05A804-TB POWER-19	16	BK	1N						220 VAC	05A550CB04				15.3.2004
5	NULL	05A804-TB POWER-19	05A804-TB POWER-21	16	BK	1N						220 VAC	05A550CB04				15.3.2004
5	NULL	05A804-TB POWER-21	05A804-TB POWER-23	16	BK	1N						220 VAC	05A550CB04				15.3.2004
5	NULL	05A804-TB POWER-23	05A804-TB POWER-25	16	BK	1N						220 VAC	05A550CB04				15.3.2004
5	NULL	05A804-TB POWER-25	05A804-TB POWER-27	16	BK	1N						220 VAC	05A550CB04				15.3.2004
5	NULL	05A804-TB POWER-27	05A804-TB POWER-29	16	BK	1N						220 VAC	05A550CB04				15.3.2004
5	NULL	05A804-TB POWER-29	05A804-TB POWER-31	16	BK	1N						220 VAC	05A550CB04				15.3.2004
5	NULL	05A804-TB POWER-31	05A805-TB POWER-01	16	BK	1N						220 VAC	05A550CB04				15.3.2004
5	NULL	05A804-TB-(+)	05A805-TB-(+)	16	WH						SOURCE 05PS01	+24 VDC	05A565CB01				15.3.2004
5	NULL	05A805-E1	05W1A	14	WH							FRM GND					15.3.2004
5	NULL	05A805-TB POWER-01	05A805-TB POWER-03	16	BK	1N						220 VAC	05A550CB04				15.3.2004
5	NULL	05A805-TB POWER-03	05A805-TB POWER-05	16	BK	1N						220 VAC	05A550CB04				15.3.2004
5	NULL	05A805-TB POWER-05	05A805-TB POWER-07	16	BK	1N						220 VAC	05A550CB04				15.3.2004
5	NULL	05A805-TB POWER-07	05A805-TB POWER-09	16	BK	1N						220 VAC	05A550CB04				15.3.2004
5	NULL	05A805-TB POWER-09	05A805-TB POWER-11	16	BK	1N						220 VAC	05A550CB04				15.3.2004
5	NULL	05A805-TB POWER-11	05A805-TB POWER-13	16	BK	1N						220 VAC	05A550CB04				15.3.2004
5	NULL	05A805-TB POWER-13	05A805-TB POWER-15	16	BK	1N						220 VAC	05A550CB04				15.3.2004
5	NULL	05A805-TB POWER-15	05A805-TB POWER-17	16	BK	1N						220 VAC	05A550CB04				15.3.2004
5	NULL	05A805-TB POWER-17	05A805-TB POWER-19	16	BK	1N						220 VAC	05A550CB04				15.3.2004
5	NULL	05A805-TB POWER-19	05A805-TB POWER-21	16	BK	1N						220 VAC	05A550CB04				15.3.2004
5	NULL	05A805-TB POWER-21	05A805-TB POWER-23	16	BK	1N						220 VAC	05A550CB04				15.3.2004
5	NULL	05A805-TB POWER-23	05A805-TB POWER-25	16	BK	1N						220 VAC	05A550CB04				15.3.2004
5	NULL	05A805-TB POWER-25	05A805-TB POWER-27	16	BK	1N						220 VAC	05A550CB04				15.3.2004
5	NULL	05A805-TB POWER-27	05A805-TB POWER-29	16	BK	1N						220 VAC	05A550CB04				15.3.2004
5	NULL	05A805-TB POWER-29	05A805-TB POWER-31	16	BK	1N						220 VAC	05A550CB04				15.3.2004
5	NULL	05A805-TB POWER-31	05A806-TB POWER-01	16	BK	1N						220 VAC	05A550CB04				15.3.2004
5	NULL	05A805-TB-(+)	05A806-TB-(+)	16	WH						SOURCE 05PS01	+24 VDC	05A565CB01				15.3.2004
5	NULL	05A806-E1	05W1A	14	WH							FRM GND					15.3.2004
5	NULL	05A806-TB POWER-01	05A806-TB POWER-03	16	BK	1N						220 VAC	05A550CB04				15.3.2004
5	NULL	05A806-TB POWER-03	05A806-TB POWER-05	16	BK	1N						220 VAC	05A550CB04				15.3.2004
5	NULL	05A806-TB POWER-05	05A806-TB POWER-07	16	BK	1N						220 VAC	05A550CB04				15.3.2004
5	NULL	05A806-TB POWER-07	05A806-TB POWER-09	16	BK	1N						220 VAC	05A550CB04				15.3.2004
5	NULL	05A806-TB POWER-09	05A806-TB POWER-11	16	BK	1N						220 VAC	05A550CB04				15.3.2004
5	NULL	05A806-TB POWER-11	05A806-TB POWER-13	16	BK	1N						220 VAC	05A550CB04				15.3.2004
5	NULL	05A806-TB POWER-13	05A806-TB POWER-15	16	BK	1N						220 VAC	05A550CB04				15.3.2004
5	NULL	05A806-TB POWER-15	05A806-TB POWER-17	16	BK	1N						220 VAC	05A550CB04				15.3.2004
5	NULL	05A806-TB POWER-17	05A806-TB POWER-19	16	BK	1N						220 VAC	05A550CB04				15.3.2004
5	NULL	05A806-TB POWER-19	05A806-TB POWER-21	16	BK	1N						220 VAC	05A550CB04				15.3.2004
5	NULL	05A806-TB POWER-21	05A806-TB POWER-23	16	BK	1N						220 VAC	05A550CB04				15.3.2004
5	NULL	05A806-TB POWER-23	05A806-TB POWER-25	16	BK	1N						220 VAC	05A550CB04				15.3.2004
5	NULL	05A806-TB POWER-25	05A806-TB POWER-27	16	BK	1N						220 VAC	05A550CB04				15.3.2004
5	NULL	05A806-TB POWER-27	05A806-TB POWER-29	16	BK	1N						220 VAC	05A550CB04				15.3.2004
5	NULL	05A806-TB POWER-29	05A806-TB POWER-31	16	BK	1N						220 VAC	05A550CB04				15.3.2004
5	NULL	05A806-TB POWER-31	05A807-TB POWER-01	16	BK	1N						220 VAC	05A550CB04				15.3.2004
5	NULL	05A806-TB-(+)	05A807-TB-(+)	16	WH						SOURCE 05PS01	+24 VDC	05A565CB01				15.3.2004
5	NULL	05A807-E1	05W1A	14	WH							FRM GND					15.3.2004

coord	coord_	From	To	WC	CC	NC	IO	SC	Word	bit	remarks	power	origin	daisy_	ped	rev_le	write_date
5	NULL	05A807-TB POWER-01	05A807-TB POWER-03	16	BK	1N						220 VAC	05A550CB04				15.3.2004
5	NULL	05A807-TB POWER-03	05A807-TB POWER-05	16	BK	1N						220 VAC	05A550CB04				15.3.2004
5	NULL	05A807-TB POWER-05	05A807-TB POWER-07	16	BK	1N						220 VAC	05A550CB04				15.3.2004
5	NULL	05A807-TB POWER-07	05A807-TB POWER-09	16	BK	1N						220 VAC	05A550CB04				15.3.2004
5	NULL	05A807-TB POWER-09	05A807-TB POWER-11	16	BK	1N						220 VAC	05A550CB04				15.3.2004
5	NULL	05A807-TB POWER-11	05A807-TB POWER-13	16	BK	1N						220 VAC	05A550CB04				15.3.2004
5	NULL	05A807-TB POWER-13	05A807-TB POWER-15	16	BK	1N						220 VAC	05A550CB04				15.3.2004
5	NULL	05A807-TB POWER-15	05A807-TB POWER-17	16	BK	1N						220 VAC	05A550CB04				15.3.2004
5	NULL	05A807-TB POWER-17	05A807-TB POWER-19	16	BK	1N						220 VAC	05A550CB04				15.3.2004
5	NULL	05A807-TB POWER-19	05A807-TB POWER-21	16	BK	1N						220 VAC	05A550CB04				15.3.2004
5	NULL	05A807-TB POWER-21	05A807-TB POWER-23	16	BK	1N						220 VAC	05A550CB04				15.3.2004
5	NULL	05A807-TB POWER-23	05A807-TB POWER-25	16	BK	1N						220 VAC	05A550CB04				15.3.2004
5	NULL	05A807-TB POWER-25	05A807-TB POWER-27	16	BK	1N						220 VAC	05A550CB04				15.3.2004
5	NULL	05A807-TB POWER-27	05A807-TB POWER-29	16	BK	1N						220 VAC	05A550CB04				15.3.2004
5	NULL	05A807-TB POWER-29	05A807-TB POWER-31	16	BK	1N						220 VAC	05A550CB04				15.3.2004
5	NULL	05A807-TB POWER-31	05A808-TB POWER-01	16	BK	1N						220 VAC	05A550CB04				15.3.2004
5	NULL	05A807-TB-(+)	05A808-TB-(+)	16	WH						SOURCE 05PS01	+24 VDC	05A565CB01				15.3.2004
5	NULL	05A808-E1	05W1A	14	WH							FRM GND					15.3.2004
5	NULL	05A808-TB POWER-01	05A808-TB POWER-03	16	BK	1N						220 VAC	05A550CB04				15.3.2004
5	NULL	05A808-TB POWER-03	05A808-TB POWER-05	16	BK	1N						220 VAC	05A550CB04				15.3.2004
5	NULL	05A808-TB POWER-05	05A808-TB POWER-07	16	BK	1N						220 VAC	05A550CB04				15.3.2004
5	NULL	05A808-TB POWER-07	05A808-TB POWER-09	16	BK	1N						220 VAC	05A550CB04				15.3.2004
5	NULL	05A808-TB POWER-09	05A808-TB POWER-11	16	BK	1N						220 VAC	05A550CB04				15.3.2004
5	NULL	05A808-TB POWER-11	05A808-TB POWER-13	16	BK	1N						220 VAC	05A550CB04				15.3.2004
5	NULL	05A808-TB POWER-13	05A808-TB POWER-15	16	BK	1N						220 VAC	05A550CB04				15.3.2004
5	NULL	05A808-TB POWER-15	05A808-TB POWER-17	16	BK	1N						220 VAC	05A550CB04				15.3.2004
5	NULL	05A808-TB POWER-17	05A808-TB POWER-19	16	BK	1N						220 VAC	05A550CB04				15.3.2004
5	NULL	05A808-TB POWER-19	05A808-TB POWER-21	16	BK	1N						220 VAC	05A550CB04				15.3.2004
5	NULL	05A808-TB POWER-21	05A808-TB POWER-23	16	BK	1N						220 VAC	05A550CB04				15.3.2004
5	NULL	05A808-TB POWER-23	05A808-TB POWER-25	16	BK	1N						220 VAC	05A550CB04				15.3.2004
5	NULL	05A808-TB POWER-25	05A808-TB POWER-27	16	BK	1N						220 VAC	05A550CB04				15.3.2004
5	NULL	05A808-TB POWER-27	05A808-TB POWER-29	16	BK	1N						220 VAC	05A550CB04				15.3.2004
5	NULL	05A808-TB POWER-29	05A808-TB POWER-31	16	BK	1N						220 VAC	05A550CB04				15.3.2004
UNIT 6																	
6	NULL	06A800-E1	06W1A	14	WH							FRM GND					15.3.2004
6	NULL	06A800-TB POWER-01	06A800-TB POWER-03	16	BK	1N						220 VAC	06A550CB03				15.3.2004
6	NULL	06A800-TB POWER-03	06A800-TB POWER-05	16	BK	1N						220 VAC	06A550CB03				15.3.2004
6	NULL	06A800-TB POWER-05	06A800-TB POWER-07	16	BK	1N						220 VAC	06A550CB03				15.3.2004
6	NULL	06A800-TB POWER-07	06A800-TB POWER-09	16	BK	1N						220 VAC	06A550CB03				15.3.2004
6	NULL	06A800-TB POWER-09	06A800-TB POWER-11	16	BK	1N						220 VAC	06A550CB03				15.3.2004
6	NULL	06A800-TB POWER-11	06A800-TB POWER-13	16	BK	1N						220 VAC	06A550CB03				15.3.2004
6	NULL	06A800-TB POWER-13	06A800-TB POWER-15	16	BK	1N						220 VAC	06A550CB03				15.3.2004
6	NULL	06A800-TB POWER-15	06A800-TB POWER-17	16	BK	1N						220 VAC	06A550CB03				15.3.2004
6	NULL	06A800-TB POWER-17	06A800-TB POWER-19	16	BK	1N						220 VAC	06A550CB03				15.3.2004
6	NULL	06A800-TB POWER-19	06A800-TB POWER-21	16	BK	1N						220 VAC	06A550CB03				15.3.2004
6	NULL	06A800-TB POWER-21	06A800-TB POWER-23	16	BK	1N						220 VAC	06A550CB03				15.3.2004
6	NULL	06A800-TB POWER-23	06A800-TB POWER-25	16	BK	1N						220 VAC	06A550CB03				15.3.2004
6	NULL	06A800-TB POWER-25	06A800-TB POWER-27	16	BK	1N						220 VAC	06A550CB03				15.3.2004
6	NULL	06A800-TB POWER-27	06A800-TB POWER-29	16	BK	1N						220 VAC	06A550CB03				15.3.2004
6	NULL	06A800-TB POWER-29	06A800-TB POWER-31	16	BK	1N						220 VAC	06A550CB03				15.3.2004
6	NULL	06A800-TB POWER-31	06A801-TB POWER-01	16	BK	1N						220 VAC	06A550CB03				15.3.2004
6	NULL	06A800-TB-(+)	06A801-TB-(+)	16	WH						SOURCE 06PS01	+24 VDC	06A565CB01				15.3.2004
6	NULL	06A800-TB-(+)	06TB201-11	16	WH						SOURCE 06PS01	+24 VDC	06A565CB01				15.3.2004
6	NULL	06A801-E1	06W1A	14	WH							FRM GND					15.3.2004

coord	coord_	From	To	WC	CC	NC	IO	SC	Word	bit	remarks	power	origin	daisy_	ped	rev_le	write_date
6	NULL	06A801-TB POWER-01	06A801-TB POWER-03	16	BK	1N						220 VAC	06A550CB03				15.3.2004
6	NULL	06A801-TB POWER-03	06A801-TB POWER-05	16	BK	1N						220 VAC	06A550CB03				15.3.2004
6	NULL	06A801-TB POWER-05	06A801-TB POWER-07	16	BK	1N						220 VAC	06A550CB03				15.3.2004
6	NULL	06A801-TB POWER-07	06A801-TB POWER-09	16	BK	1N						220 VAC	06A550CB03				15.3.2004
6	NULL	06A801-TB POWER-09	06A801-TB POWER-11	16	BK	1N						220 VAC	06A550CB03				15.3.2004
6	NULL	06A801-TB POWER-11	06A801-TB POWER-13	16	BK	1N						220 VAC	06A550CB03				15.3.2004
6	NULL	06A801-TB POWER-13	06A801-TB POWER-15	16	BK	1N						220 VAC	06A550CB03				15.3.2004
6	NULL	06A801-TB POWER-15	06A801-TB POWER-17	16	BK	1N						220 VAC	06A550CB03				15.3.2004
6	NULL	06A801-TB POWER-17	06A801-TB POWER-19	16	BK	1N						220 VAC	06A550CB03				15.3.2004
6	NULL	06A801-TB POWER-19	06A801-TB POWER-21	16	BK	1N						220 VAC	06A550CB03				15.3.2004
6	NULL	06A801-TB POWER-21	06A801-TB POWER-23	16	BK	1N						220 VAC	06A550CB03				15.3.2004
6	NULL	06A801-TB POWER-23	06A801-TB POWER-25	16	BK	1N						220 VAC	06A550CB03				15.3.2004
6	NULL	06A801-TB POWER-25	06A801-TB POWER-27	16	BK	1N						220 VAC	06A550CB03				15.3.2004
6	NULL	06A801-TB POWER-27	06A801-TB POWER-29	16	BK	1N						220 VAC	06A550CB03				15.3.2004
6	NULL	06A801-TB POWER-29	06A801-TB POWER-31	16	BK	1N						220 VAC	06A550CB03				15.3.2004
6	NULL	06A801-TB POWER-31	06A802-TB POWER-01	16	BK	1N						220 VAC	06A550CB03				15.3.2004
6	NULL	06A801-TB-(+)	06A802-TB-(+)	16	WH						SOURCE 06PS01	+24 VDC	06A565CB01				15.3.2004
6	NULL	06A802-E1	06W1A	14	WH							FRM GND					15.3.2004
6	NULL	06A802-TB POWER-01	06A802-TB POWER-03	16	BK	1N						220 VAC	06A550CB03				15.3.2004
6	NULL	06A802-TB POWER-03	06A802-TB POWER-05	16	BK	1N						220 VAC	06A550CB03				15.3.2004
6	NULL	06A802-TB POWER-05	06A802-TB POWER-07	16	BK	1N						220 VAC	06A550CB03				15.3.2004
6	NULL	06A802-TB POWER-07	06A802-TB POWER-09	16	BK	1N						220 VAC	06A550CB03				15.3.2004
6	NULL	06A802-TB POWER-09	06A802-TB POWER-11	16	BK	1N						220 VAC	06A550CB03				15.3.2004
6	NULL	06A802-TB POWER-11	06A802-TB POWER-13	16	BK	1N						220 VAC	06A550CB03				15.3.2004
6	NULL	06A802-TB POWER-13	06A802-TB POWER-15	16	BK	1N						220 VAC	06A550CB03				15.3.2004
6	NULL	06A802-TB POWER-15	06A802-TB POWER-17	16	BK	1N						220 VAC	06A550CB03				15.3.2004
6	NULL	06A802-TB POWER-17	06A802-TB POWER-19	16	BK	1N						220 VAC	06A550CB03				15.3.2004
6	NULL	06A802-TB POWER-19	06A802-TB POWER-21	16	BK	1N						220 VAC	06A550CB03				15.3.2004
6	NULL	06A802-TB POWER-21	06A802-TB POWER-23	16	BK	1N						220 VAC	06A550CB03				15.3.2004
6	NULL	06A802-TB POWER-23	06A802-TB POWER-25	16	BK	1N						220 VAC	06A550CB03				15.3.2004
6	NULL	06A802-TB POWER-25	06A802-TB POWER-27	16	BK	1N						220 VAC	06A550CB03				15.3.2004
6	NULL	06A802-TB POWER-27	06A802-TB POWER-29	16	BK	1N						220 VAC	06A550CB03				15.3.2004
6	NULL	06A802-TB POWER-29	06A802-TB POWER-31	16	BK	1N						220 VAC	06A550CB03				15.3.2004
6	NULL	06A802-TB POWER-31	06A803-TB POWER-01	16	BK	1N						220 VAC	06A550CB03				15.3.2004
6	NULL	06A802-TB-(+)	06A803-TB-(+)	16	WH						SOURCE 06PS01	+24 VDC	06A565CB01				15.3.2004
6	NULL	06A803-E1	06W1A	14	WH							FRM GND					15.3.2004
6	NULL	06A803-TB POWER-01	06A803-TB POWER-03	16	BK	1N						220 VAC	06A550CB03				15.3.2004
6	NULL	06A803-TB POWER-03	06A803-TB POWER-05	16	BK	1N						220 VAC	06A550CB03				15.3.2004
6	NULL	06A803-TB POWER-05	06A803-TB POWER-07	16	BK	1N						220 VAC	06A550CB03				15.3.2004
6	NULL	06A803-TB POWER-07	06A803-TB POWER-09	16	BK	1N						220 VAC	06A550CB03				15.3.2004
6	NULL	06A803-TB POWER-09	06A803-TB POWER-11	16	BK	1N						220 VAC	06A550CB03				15.3.2004
6	NULL	06A803-TB POWER-11	06A803-TB POWER-13	16	BK	1N						220 VAC	06A550CB03				15.3.2004
6	NULL	06A803-TB POWER-13	06A803-TB POWER-15	16	BK	1N						220 VAC	06A550CB03				15.3.2004
6	NULL	06A803-TB POWER-15	06A803-TB POWER-17	16	BK	1N						220 VAC	06A550CB03				15.3.2004
6	NULL	06A803-TB POWER-17	06A803-TB POWER-19	16	BK	1N						220 VAC	06A550CB03				15.3.2004
6	NULL	06A803-TB POWER-19	06A803-TB POWER-21	16	BK	1N						220 VAC	06A550CB03				15.3.2004
6	NULL	06A803-TB POWER-21	06A803-TB POWER-23	16	BK	1N						220 VAC	06A550CB03				15.3.2004
6	NULL	06A803-TB POWER-23	06A803-TB POWER-25	16	BK	1N						220 VAC	06A550CB03				15.3.2004
6	NULL	06A803-TB POWER-25	06A803-TB POWER-27	16	BK	1N						220 VAC	06A550CB03				15.3.2004
6	NULL	06A803-TB POWER-27	06A803-TB POWER-29	16	BK	1N						220 VAC	06A550CB03				15.3.2004
6	NULL	06A803-TB POWER-29	06A803-TB POWER-31	16	BK	1N						220 VAC	06A550CB03				15.3.2004
6	NULL	06A803-TB POWER-31	06A804-TB POWER-01	16	BK	1N						220 VAC	06A550CB03				15.3.2004
6	NULL	06A803-TB-(+)	06A804-TB-(+)	16	WH						SOURCE 06PS01	+24 VDC	06A565CB01				15.3.2004
6	NULL	06A804-E1	06W1A	14	WH							FRM GND					15.3.2004

coord	coord_	From	To	WC	CC	NC	IO	SC	Word	bit	remarks	power	origin	daisy_	ped	rev_le	write_date
6	NULL	06A804-TB POWER-01	06A804-TB POWER-03	16	BK	1N						220 VAC	06A550CB03				15.3.2004
6	NULL	06A804-TB POWER-03	06A804-TB POWER-05	16	BK	1N						220 VAC	06A550CB03				15.3.2004
6	NULL	06A804-TB POWER-05	06A804-TB POWER-07	16	BK	1N						220 VAC	06A550CB03				15.3.2004
6	NULL	06A804-TB POWER-07	06A804-TB POWER-09	16	BK	1N						220 VAC	06A550CB03				15.3.2004
6	NULL	06A804-TB POWER-09	06A804-TB POWER-11	16	BK	1N						220 VAC	06A550CB03				15.3.2004
6	NULL	06A804-TB POWER-11	06A804-TB POWER-13	16	BK	1N						220 VAC	06A550CB03				15.3.2004
6	NULL	06A804-TB POWER-13	06A804-TB POWER-15	16	BK	1N						220 VAC	06A550CB03				15.3.2004
6	NULL	06A804-TB POWER-15	06A804-TB POWER-17	16	BK	1N						220 VAC	06A550CB03				15.3.2004
6	NULL	06A804-TB POWER-17	06A804-TB POWER-19	16	BK	1N						220 VAC	06A550CB03				15.3.2004
6	NULL	06A804-TB POWER-19	06A804-TB POWER-21	16	BK	1N						220 VAC	06A550CB03				15.3.2004
6	NULL	06A804-TB POWER-21	06A804-TB POWER-23	16	BK	1N						220 VAC	06A550CB03				15.3.2004
6	NULL	06A804-TB POWER-23	06A804-TB POWER-25	16	BK	1N						220 VAC	06A550CB03				15.3.2004
6	NULL	06A804-TB POWER-25	06A804-TB POWER-27	16	BK	1N						220 VAC	06A550CB03				15.3.2004
6	NULL	06A804-TB POWER-27	06A804-TB POWER-29	16	BK	1N						220 VAC	06A550CB03				15.3.2004
6	NULL	06A804-TB POWER-29	06A804-TB POWER-31	16	BK	1N						220 VAC	06A550CB03				15.3.2004
6	NULL	06A804-TB-(+)	06A805-TB-(+)	16	WH						SOURCE 06PS01	+24 VDC	06A565CB01				15.3.2004
6	NULL	06A805-E1	06W1A	14	WH							FRM GND					15.3.2004
6	NULL	06A805-TB POWER-01	06A805-TB POWER-03	16	BK	1N						220 VAC	06A550CB04				15.3.2004
6	NULL	06A805-TB POWER-03	06A805-TB POWER-05	16	BK	1N						220 VAC	06A550CB04				15.3.2004
6	NULL	06A805-TB POWER-05	06A805-TB POWER-07	16	BK	1N						220 VAC	06A550CB04				15.3.2004
6	NULL	06A805-TB POWER-07	06A805-TB POWER-09	16	BK	1N						220 VAC	06A550CB04				15.3.2004
6	NULL	06A805-TB POWER-09	06A805-TB POWER-11	16	BK	1N						220 VAC	06A550CB04				15.3.2004
6	NULL	06A805-TB POWER-11	06A805-TB POWER-13	16	BK	1N						220 VAC	06A550CB04				15.3.2004
6	NULL	06A805-TB POWER-13	06A805-TB POWER-15	16	BK	1N						220 VAC	06A550CB04				15.3.2004
6	NULL	06A805-TB POWER-15	06A805-TB POWER-17	16	BK	1N						220 VAC	06A550CB04				15.3.2004
6	NULL	06A805-TB POWER-17	06A805-TB POWER-19	16	BK	1N						220 VAC	06A550CB04				15.3.2004
6	NULL	06A805-TB POWER-19	06A805-TB POWER-21	16	BK	1N						220 VAC	06A550CB04				15.3.2004
6	NULL	06A805-TB POWER-21	06A805-TB POWER-23	16	BK	1N						220 VAC	06A550CB04				15.3.2004
6	NULL	06A805-TB POWER-23	06A805-TB POWER-25	16	BK	1N						220 VAC	06A550CB04				15.3.2004
6	NULL	06A805-TB POWER-25	06A805-TB POWER-27	16	BK	1N						220 VAC	06A550CB04				15.3.2004
6	NULL	06A805-TB POWER-27	06A805-TB POWER-29	16	BK	1N						220 VAC	06A550CB04				15.3.2004
6	NULL	06A805-TB POWER-29	06A805-TB POWER-31	16	BK	1N						220 VAC	06A550CB04				15.3.2004
6	NULL	06A805-TB POWER-31	06A806-TB POWER-01	16	BK	1N						220 VAC	06A550CB04				15.3.2004
6	NULL	06A805-TB-(+)	06A806-TB-(+)	16	WH						SOURCE 06PS01	+24 VDC	06A565CB01				15.3.2004
6	NULL	06A806-E1	06W1A	14	WH							FRM GND					15.3.2004
6	NULL	06A806-TB POWER-01	06A806-TB POWER-03	16	BK	1N						220 VAC	06A550CB04				15.3.2004
6	NULL	06A806-TB POWER-03	06A806-TB POWER-05	16	BK	1N						220 VAC	06A550CB04				15.3.2004
6	NULL	06A806-TB POWER-05	06A806-TB POWER-07	16	BK	1N						220 VAC	06A550CB04				15.3.2004
6	NULL	06A806-TB POWER-07	06A806-TB POWER-09	16	BK	1N						220 VAC	06A550CB04				15.3.2004
6	NULL	06A806-TB POWER-09	06A806-TB POWER-11	16	BK	1N						220 VAC	06A550CB04				15.3.2004
6	NULL	06A806-TB POWER-11	06A806-TB POWER-13	16	BK	1N						220 VAC	06A550CB04				15.3.2004
6	NULL	06A806-TB POWER-13	06A806-TB POWER-15	16	BK	1N						220 VAC	06A550CB04				15.3.2004
6	NULL	06A806-TB POWER-15	06A806-TB POWER-17	16	BK	1N						220 VAC	06A550CB04				15.3.2004
6	NULL	06A806-TB POWER-17	06A806-TB POWER-19	16	BK	1N						220 VAC	06A550CB04				15.3.2004
6	NULL	06A806-TB POWER-19	06A806-TB POWER-21	16	BK	1N						220 VAC	06A550CB04				15.3.2004
6	NULL	06A806-TB POWER-21	06A806-TB POWER-23	16	BK	1N						220 VAC	06A550CB04				15.3.2004
6	NULL	06A806-TB POWER-23	06A806-TB POWER-25	16	BK	1N						220 VAC	06A550CB04				15.3.2004
6	NULL	06A806-TB POWER-25	06A806-TB POWER-27	16	BK	1N						220 VAC	06A550CB04				15.3.2004
6	NULL	06A806-TB POWER-27	06A806-TB POWER-29	16	BK	1N						220 VAC	06A550CB04				15.3.2004
6	NULL	06A806-TB POWER-29	06A806-TB POWER-31	16	BK	1N						220 VAC	06A550CB04				15.3.2004
6	NULL	06A806-TB POWER-31	06A807-TB POWER-01	16	BK	1N						220 VAC	06A550CB04				15.3.2004
6	NULL	06A806-TB-(+)	06A807-TB-(+)	16	WH						SOURCE 06PS01	+24 VDC	06A565CB01				15.3.2004
6	NULL	06A807-E1	06W1A	14	WH							FRM GND					15.3.2004
6	NULL	06A807-TB POWER-01	06A807-TB POWER-03	16	BK	1N						220 VAC	06A550CB04				15.3.2004

coord	coord_	From	To	WC	CC	NC	IO	SC	Word	bit	remarks	power	origin	daisy_	ped	rev_le	write_date
6	NULL	06A807-TB POWER-03	06A807-TB POWER-05	16	BK	1N						220 VAC	06A550CB04				15.3.2004
6	NULL	06A807-TB POWER-05	06A807-TB POWER-07	16	BK	1N						220 VAC	06A550CB04				15.3.2004
6	NULL	06A807-TB POWER-07	06A807-TB POWER-09	16	BK	1N						220 VAC	06A550CB04				15.3.2004
6	NULL	06A807-TB POWER-09	06A807-TB POWER-11	16	BK	1N						220 VAC	06A550CB04				15.3.2004
6	NULL	06A807-TB POWER-11	06A807-TB POWER-13	16	BK	1N						220 VAC	06A550CB04				15.3.2004
6	NULL	06A807-TB POWER-13	06A807-TB POWER-15	16	BK	1N						220 VAC	06A550CB04				15.3.2004
6	NULL	06A807-TB POWER-15	06A807-TB POWER-17	16	BK	1N						220 VAC	06A550CB04				15.3.2004
6	NULL	06A807-TB POWER-17	06A807-TB POWER-19	16	BK	1N						220 VAC	06A550CB04				15.3.2004
6	NULL	06A807-TB POWER-19	06A807-TB POWER-21	16	BK	1N						220 VAC	06A550CB04				15.3.2004
6	NULL	06A807-TB POWER-21	06A807-TB POWER-23	16	BK	1N						220 VAC	06A550CB04				15.3.2004
6	NULL	06A807-TB POWER-23	06A807-TB POWER-25	16	BK	1N						220 VAC	06A550CB04				15.3.2004
6	NULL	06A807-TB POWER-25	06A807-TB POWER-27	16	BK	1N						220 VAC	06A550CB04				15.3.2004
6	NULL	06A807-TB POWER-27	06A807-TB POWER-29	16	BK	1N						220 VAC	06A550CB04				15.3.2004
6	NULL	06A807-TB POWER-29	06A807-TB POWER-31	16	BK	1N						220 VAC	06A550CB04				15.3.2004
6	NULL	06A807-TB POWER-31	06A808-TB POWER-01	16	BK	1N						220 VAC	06A550CB04				15.3.2004
6	NULL	06A807-TB-(+)	06A808-TB-(+)	16	WH						SOURCE 06PS01	+24 VDC	06A565CB01				15.3.2004
6	NULL	06A808-E1	06W1A	14	WH							FRM GND					15.3.2004
6	NULL	06A808-TB POWER-01	06A808-TB POWER-03	16	BK	1N						220 VAC	06A550CB04				15.3.2004
6	NULL	06A808-TB POWER-03	06A808-TB POWER-05	16	BK	1N						220 VAC	06A550CB04				15.3.2004
6	NULL	06A808-TB POWER-05	06A808-TB POWER-07	16	BK	1N						220 VAC	06A550CB04				15.3.2004
6	NULL	06A808-TB POWER-07	06A808-TB POWER-09	16	BK	1N						220 VAC	06A550CB04				15.3.2004
6	NULL	06A808-TB POWER-09	06A808-TB POWER-11	16	BK	1N						220 VAC	06A550CB04				15.3.2004
6	NULL	06A808-TB POWER-11	06A808-TB POWER-13	16	BK	1N						220 VAC	06A550CB04				15.3.2004
6	NULL	06A808-TB POWER-13	06A808-TB POWER-15	16	BK	1N						220 VAC	06A550CB04				15.3.2004
6	NULL	06A808-TB POWER-15	06A808-TB POWER-17	16	BK	1N						220 VAC	06A550CB04				15.3.2004
6	NULL	06A808-TB POWER-17	06A808-TB POWER-19	16	BK	1N						220 VAC	06A550CB04				15.3.2004
6	NULL	06A808-TB POWER-19	06A808-TB POWER-21	16	BK	1N						220 VAC	06A550CB04				15.3.2004
6	NULL	06A808-TB POWER-21	06A808-TB POWER-23	16	BK	1N						220 VAC	06A550CB04				15.3.2004
6	NULL	06A808-TB POWER-23	06A808-TB POWER-25	16	BK	1N						220 VAC	06A550CB04				15.3.2004
6	NULL	06A808-TB POWER-25	06A808-TB POWER-27	16	BK	1N						220 VAC	06A550CB04				15.3.2004
6	NULL	06A808-TB POWER-27	06A808-TB POWER-29	16	BK	1N						220 VAC	06A550CB04				15.3.2004
6	NULL	06A808-TB POWER-29	06A808-TB POWER-31	16	BK	1N						220 VAC	06A550CB04				15.3.2004
6	NULL	06A808-TB POWER-31	06A809-TB POWER-01	16	BK	1N						220 VAC	06A550CB04				15.3.2004
6	NULL	06A808-TB-(+)	06A809-TB-(+)	16	WH						SOURCE 06PS01	+24 VDC	06A565CB01				15.3.2004
6	NULL	06A809-E1	06W1A	14	WH							FRM GND					15.3.2004
6	NULL	06A809-TB POWER-01	06A809-TB POWER-03	16	BK	1N						220 VAC	06A550CB04				15.3.2004
6	NULL	06A809-TB POWER-03	06A809-TB POWER-05	16	BK	1N						220 VAC	06A550CB04				15.3.2004
6	NULL	06A809-TB POWER-05	06A809-TB POWER-07	16	BK	1N						220 VAC	06A550CB04				15.3.2004
6	NULL	06A809-TB POWER-07	06A809-TB POWER-09	16	BK	1N						220 VAC	06A550CB04				15.3.2004
6	NULL	06A809-TB POWER-09	06A809-TB POWER-11	16	BK	1N						220 VAC	06A550CB04				15.3.2004
6	NULL	06A809-TB POWER-11	06A809-TB POWER-13	16	BK	1N						220 VAC	06A550CB04				15.3.2004
6	NULL	06A809-TB POWER-13	06A809-TB POWER-15	16	BK	1N						220 VAC	06A550CB04				15.3.2004
6	NULL	06A809-TB POWER-15	06A809-TB POWER-17	16	BK	1N						220 VAC	06A550CB04				15.3.2004
6	NULL	06A809-TB POWER-17	06A809-TB POWER-19	16	BK	1N						220 VAC	06A550CB04				15.3.2004
6	NULL	06A809-TB POWER-19	06A809-TB POWER-21	16	BK	1N						220 VAC	06A550CB04				15.3.2004
6	NULL	06A809-TB POWER-21	06A809-TB POWER-23	16	BK	1N						220 VAC	06A550CB04				15.3.2004
6	NULL	06A809-TB POWER-23	06A809-TB POWER-25	16	BK	1N						220 VAC	06A550CB04				15.3.2004
6	NULL	06A809-TB POWER-25	06A809-TB POWER-27	16	BK	1N						220 VAC	06A550CB04				15.3.2004
6	NULL	06A809-TB POWER-27	06A809-TB POWER-29	16	BK	1N						220 VAC	06A550CB04				15.3.2004
6	NULL	06A809-TB POWER-29	06A809-TB POWER-31	16	BK	1N						220 VAC	06A550CB04				15.3.2004
6	NULL	06A809-TB-(+)	06A810-TB-(+)	16	WH						SOURCE 06PS01	+24 VDC	06A565CB01			D	15.3.2004
6	NULL	06A810-E1	06W1B	14	WH							FRM GND					15.3.2004
6	NULL	06A810-TB-(+)	06A811-TB-(+)	16	WH						SOURCE 06PS01	+24 VDC	06A565CB01			D	15.3.2004
6	NULL	06A811-E1	06W1B	14	WH							FRM GND					15.3.2004

Списък на връзки за премахване

coord	coord_	From	To	WC	CC	NC	IO	SC	Word	bit	remarks	power	origin	daisy_	ped	rev_le	write_date
6	NULL	06A811-TB POWER-31	06A812-TB POWER-01	14	BK	1N						220 VAC	06A550CB10			D	15.3.2004
6	NULL	06A811-TB-(+)	06A812-TB-(+)	16	WH						SOURCE 06PS01	+24 VDC	06A565CB01			D	15.3.2004
6	NULL	06A812-E1	06W1A	14	WH							FRM GND					15.3.2004
6	NULL	06A812-E1	06W1B	14	WH							FRM GND				D	15.3.2004
6	NULL	06A812-TB POWER-01	06A812-TB POWER-03	16	BK	1N						220 VAC	06A550CB10			D	15.3.2004
6	NULL	06A812-TB POWER-03	06A812-TB POWER-05	16	BK	1N						220 VAC	06A550CB10			D	15.3.2004
6	NULL	06A812-TB POWER-05	06A812-TB POWER-07	16	BK	1N						220 VAC	06A550CB10			D	15.3.2004
6	NULL	06A812-TB POWER-07	06A812-TB POWER-09	16	BK	1N						220 VAC	06A550CB10			D	15.3.2004
6	NULL	06A812-TB POWER-09	06A812-TB POWER-11	16	BK	1N						220 VAC	06A550CB10			D	15.3.2004
6	NULL	06A812-TB POWER-11	06A812-TB POWER-13	16	BK	1N						220 VAC	06A550CB10			D	15.3.2004
6	NULL	06A812-TB POWER-13	06A812-TB POWER-15	16	BK	1N						220 VAC	06A550CB10			D	15.3.2004
6	NULL	06A812-TB POWER-15	06A812-TB POWER-17	16	BK	1N						220 VAC	06A550CB10			D	15.3.2004
6	NULL	06A812-TB POWER-17	06A812-TB POWER-19	16	BK	1N						220 VAC	06A550CB10			D	15.3.2004
6	NULL	06A812-TB POWER-19	06A812-TB POWER-21	16	BK	1N						220 VAC	06A550CB10			D	15.3.2004
6	NULL	06A812-TB POWER-21	06A812-TB POWER-23	16	BK	1N						220 VAC	06A550CB10			D	15.3.2004
6	NULL	06A812-TB POWER-23	06A812-TB POWER-25	16	BK	1N						220 VAC	06A550CB10			D	15.3.2004
6	NULL	06A812-TB POWER-25	06A812-TB POWER-27	16	BK	1N						220 VAC	06A550CB10			D	15.3.2004
6	NULL	06A812-TB POWER-27	06A812-TB POWER-29	16	BK	1N						220 VAC	06A550CB10			D	15.3.2004
6	NULL	06A812-TB POWER-29	06A812-TB POWER-31	16	BK	1N						220 VAC	06A550CB10			D	15.3.2004
6	NULL	06A812-TB POWER-31	06A813-TB POWER-01	16	BK	1N						220 VAC	06A550CB10			D	15.3.2004
6	NULL	06A812-TB-(+)	06A813-TB-(+)	16	WH						SOURCE 06PS01	+24 VDC	06A565CB01			D	15.3.2004
6	NULL	06A813-E1	06W1A	14	WH							FRM GND					15.3.2004
6	NULL	06A813-E1	06W1B	14	WH							FRM GND				D	15.3.2004
6	NULL	06A813-TB POWER-01	06A813-TB POWER-03	16	BK	1N						220 VAC	06A550CB10			D	15.3.2004
6	NULL	06A813-TB POWER-03	06A813-TB POWER-05	16	BK	1N						220 VAC	06A550CB10			D	15.3.2004
6	NULL	06A813-TB POWER-05	06A813-TB POWER-07	16	BK	1N						220 VAC	06A550CB10			D	15.3.2004
6	NULL	06A813-TB POWER-07	06A813-TB POWER-09	16	BK	1N						220 VAC	06A550CB10			D	15.3.2004
6	NULL	06A813-TB POWER-09	06A813-TB POWER-11	16	BK	1N						220 VAC	06A550CB10			D	15.3.2004
6	NULL	06A813-TB POWER-11	06A813-TB POWER-13	16	BK	1N						220 VAC	06A550CB10			D	15.3.2004
6	NULL	06A813-TB POWER-13	06A813-TB POWER-15	16	BK	1N						220 VAC	06A550CB10			D	15.3.2004
6	NULL	06A813-TB POWER-15	06A813-TB POWER-17	16	BK	1N						220 VAC	06A550CB10			D	15.3.2004
6	NULL	06A813-TB POWER-17	06A813-TB POWER-19	16	BK	1N						220 VAC	06A550CB10			D	15.3.2004
6	NULL	06A813-TB POWER-19	06A813-TB POWER-21	16	BK	1N						220 VAC	06A550CB10			D	15.3.2004
6	NULL	06A813-TB POWER-21	06A813-TB POWER-23	16	BK	1N						220 VAC	06A550CB10			D	15.3.2004
6	NULL	06A813-TB POWER-23	06A813-TB POWER-25	16	BK	1N						220 VAC	06A550CB10			D	15.3.2004
6	NULL	06A813-TB POWER-25	06A813-TB POWER-27	16	BK	1N						220 VAC	06A550CB10			D	15.3.2004
6	NULL	06A813-TB POWER-27	06A813-TB POWER-29	16	BK	1N						220 VAC	06A550CB10			D	15.3.2004
6	NULL	06A813-TB POWER-29	06A813-TB POWER-31	16	BK	1N						220 VAC	06A550CB10			D	15.3.2004